



# PRODUCT CATALOG

FAUCETS | SINKS | GAS CONNECTORS | CASTERS

February 2023



ABOUT US

Where **passion** meets **precision.**™

**Krowne** is now celebrating our **74th anniversary** as a family-owned company manufacturing in the U.S.A! Our products range from custom underbar equipment and refrigeration to durable high quality faucets and pre-rinses.

**3 Generations**  
Krowne has been **family-owned** and manufacturing in the U.S.A. for **three generations.**

**74 Years**  
With over **70 years of experience**, Krowne is an **industry leader** in design and innovation.

**250 Thousand sq ft.**  
Krowne has rapidly expanded our manufacturing and distribution facilities to over **250,000 sq ft in the USA.**

#### **PURCHASE**

✉ [orders@krowne.com](mailto:orders@krowne.com)

#### **CONTACT**

✉ [sales@krowne.com](mailto:sales@krowne.com)

☎ 800.631.0442

#### **FOLLOW**

f t in @krowne

📷 🎵 @krownemetal

#### **VISIT**

100 Haul Road  
Wayne, NJ 07470  
[krowne.com](http://krowne.com)

# CONTENTS

<b>Diamond Series Plumbing</b>	Pre-Rinse Units & Replacement Parts	<b>10</b>
	Faucets & Replacement Parts	<b>13</b>
	Electronic Faucets	<b>15</b>
	Rotary Twist Waste Valves	<b>15</b>
<b>Royal Series Plumbing</b>	Pre-Rinse Units & Replacement Parts	<b>17</b>
	Faucets & Replacement Parts	<b>26</b>
	Water Line & Mounting Kits	<b>38</b>
	Valves & Handles	<b>40</b>
	Spouts	<b>41</b>
	Coupling Flanges & Coupling Flange Adapters	<b>42</b>
	Adapters & Vacuum Breakers	<b>44</b>
	Aerators/Outlets	<b>45</b>
	Lavatory Faucets	<b>46</b>
	Electronic Sensor Faucets & Accessories	<b>52</b>
<b>Silver Series Plumbing</b>	Faucets	<b>59</b>
	Replacement Parts	<b>64</b>
<b>Drains</b>	Waste Drains & Replacement Parts	<b>66</b>
	Sink Drains	<b>69</b>
	Overflow Pipes	<b>70</b>
<b>Hand Sinks</b>	16"W Hand Sinks	<b>72</b>
	12"W Hand Sinks	<b>78</b>
	9"W Space Saver Hand Sinks	<b>81</b>
	ADA Compliant Hand Sinks	<b>82</b>
	Specialty Hand Sinks	<b>82</b>
	Hand Sink Parts & Accessories	<b>83</b>
	Drop-In Sinks	<b>85</b>
	Scullery Sinks	<b>86</b>
	Specialty Sinks with Legs	<b>86</b>
	Sink & Floor Strainers	<b>87</b>
<b>Gas Connectors</b>	Complete Kit	<b>89</b>
	Custom Kits	<b>89</b>
	Stationary Gas Connectors	<b>94</b>
	Gas Connector Parts & Accessories	<b>94</b>
<b>Specialty Products</b>	Grease Filters	<b>96</b>
	HydroSift Water Filters	<b>97</b>
	Wok Faucets	<b>98</b>
	Utility Sprays	<b>100</b>
	Pot Fillers	<b>101</b>
	Hose Reels	<b>102</b>
	Test Strips	<b>103</b>
	Wobble Wedges	<b>103</b>
	Refrigeration Accessories	<b>104</b>
	Fryer Accessories	<b>105</b>
	Ice & Water Service Stations	<b>106</b>
	Drop-In Ice Bins	<b>106</b>
	Ice & Water Service Station Accessories	<b>107</b>
<b>Casters</b>	Adjustable Height Casters	<b>109</b>
	Royal Series Casters	<b>110</b>
	Economy Casters	<b>117</b>

# FaucetFlex™ 2.0

by Krowne

## Configure your faucet to your spec

Instant 3D Renderings • Unlimited Configurations • No Special Software Required

### Includes New Features

- New user interface
- New product additions
- Mobile friendly
- Instant spec sheet generation
- Instant price generation
- Built-in savings calculator

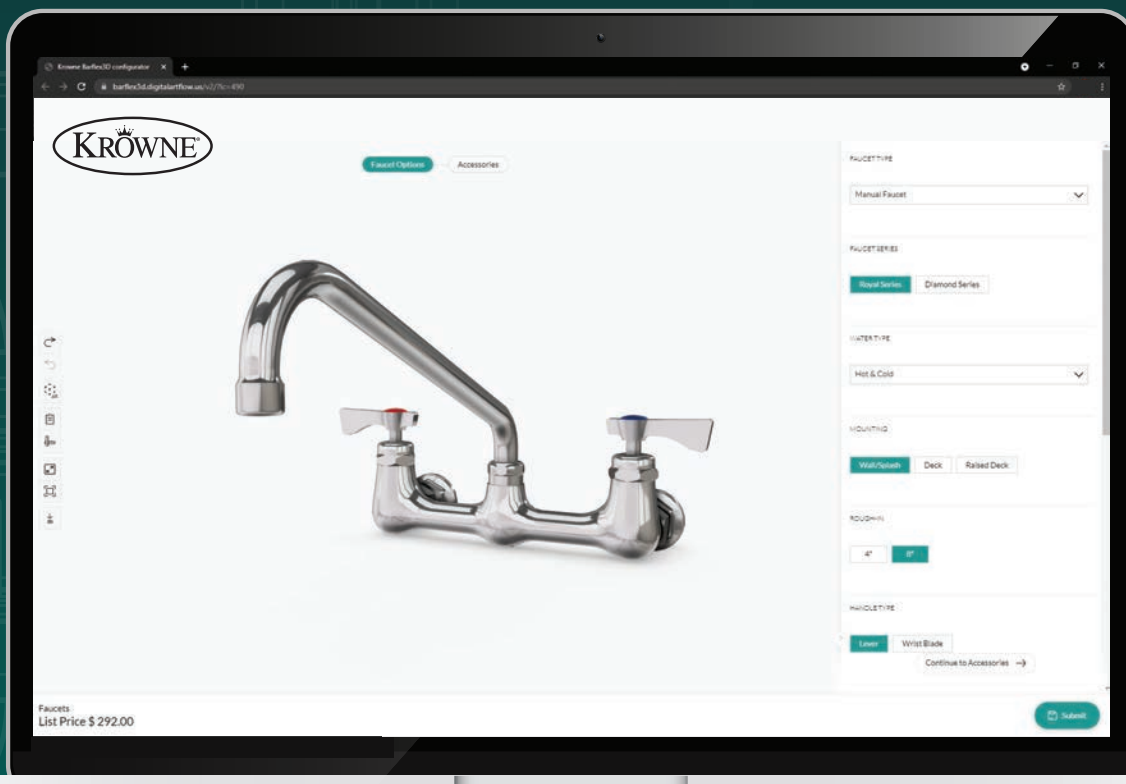

# How easy is it to build your perfect faucet?

**1** Choose your  
body style



**2** Choose your  
spout style

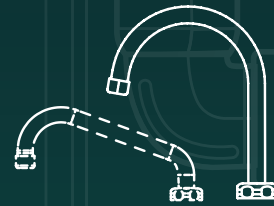

**3** Choose your  
outlet style



## New Product Additions

- Pre-Rinse Units
- Electronic Faucets
- Lavatory Faucets
- Pot Fillers
- Service Sink Faucets
- and much more!



Start building at  
**FaucetFlex.com**

# Krowne Displays

At Krowne, our **Showroom Display Program** offers the opportunity to showcase the Krowne Plumbing line while allowing customers to interact with the actual products.

Available in multiple configurations to adapt to most counter and showroom areas, we can help spotlight the Krowne product offering for your location.

Reach out to your sales representative or [sales@krowne.com](mailto:sales@krowne.com) today!



## Display Benefits

- Free Display
- Free Display Faucets
- Free Freight
- 90 Day Billing
- Special Discount

# Combo Display

Our 48" combination display offers a hybrid of slot-wall and off-the-shelf product placement.

This display is great for high-volume locations with an emphasis on quality and availability.

## Suggested Items Ordered with Display

- 17-108WL
- 17-109WL
- 14-812L
- 14-8XXL
- 16-281
- 21-129L
- 21-139L
- 21-133L
- 21-300L
- 21-308L
- 21-309L
- 21-421L
- 21-422L
- 21-423L
- 21-424L
- 21-428L
- 21-445L
- 21-192L
- 22-204
- 10-400L
- HS-2L
- 22-502
- 15-3XXL
- 15-5XXL



Combo Display



Freestanding Display

# Freestanding Display

Our 36" freestanding display features a showroom quality slot-wall configuration showcasing some of our most popular products.

This space saving display is a great choice for small to mid-size counters, showrooms, and more!

## Suggested Items Ordered with Display

- 17-108WL
- 17-109WL
- 14-812L
- 14-8XXL
- 12-812L
- 16-281
- 21-129L
- 21-139L
- 21-133L
- 21-300L
- 21-308L
- 21-309L
- 21-421L
- 21-422L
- 21-423L
- 21-424L
- 21-192L
- 21-193L
- 22-204
- 10-400L
- 11-406L
- HS-9L
- HS-2L

# DIAMOND™ series

A LUXURY PLUMBING COLLECTION



**Diamond Series** products are the obvious choice when quality and design are your top priority. Every Diamond Series product is precisely engineered and manufactured using premium components to create a durable and lasting solution supported by an **industry leading lifetime warranty**.

## Diamond Series Offerings:

- Wall/Deck Mount Pre-Rinses
- Wall/Deck Mount Manual Faucets
- Wall Mount Electronic Sensor Faucets
- Rotary Twist Waste Drains





# DETAILS MATTER.

As a family-owned company for over 70 years, we take personal pride in the process of researching, developing and releasing innovative products to our growing industry. The launch of the Diamond Series product line brings premier performance to the kitchen while integrating unique aesthetic designs & finishes.



## Industry Leading Lifetime Warranty

Cutting-edge engineering and world-class components allow us to offer an industry first lifetime warranty on all Diamond Series products.



## Sleek Aesthetic with Ultra-Polish Satin Finish

Sharp contrasting lines blended with a bright satin finish creates a modern captivating appeal.



## 1/4 Turn High Performance Stainless Steel Ceramic Cartridge Valves with Integral Check

Engineered and rigorously tested to execute over 2 million turns at optimal performance.



## Integral Smooth-Spin Swivel

Multi-spray functionality on our Diamond Series Spray Head.



## All Accessories Included

High quality install kits packaged with all Diamond Series faucets and pre-rinses for simple installation.

# Diamond Series Pre-Rinse Units

**Stainless Steel Hyperflex  
Reinforced Hose**

Extends lifespan

**Integral Smooth-Spin Swivel**

Prevents tension build up on hose

**Dura-Spring**

Increased coils  
reduces stress on hose

**Wall Bracket**

Fully adjustable

**Variable Spray Pattern**

Rotate spray head for different spray style

**Ultra-Polish Satin Finish**



## DUAL SPRAY TECHNOLOGY

**Knife Pattern**

Wide, fan-like pattern for large surface areas

**Shower Pattern**

Tight, high-powered shower pattern for tough grime

# Diamond Series Pre-Rinse Units

## Features apply to all Diamond Series Pre-Rinse Units

- Dual Spray Technology
- Ultra-polish satin finish on solid brass base
- ¼ Turn high performance stainless steel ceramic cartridge valves with integral check
- 1.15 GPM spray head
- Includes wall bracket
- Pre-assembled to cut installation time



**8" Center Wall  
Mount Pre-Rinse**

- 8" centers
- ½" NPT female inlets
- 35" high with 15" overhang
- Mounting kit & flexible water lines included

Model  
**DX-108**



**8" Center Wall  
Mount Pre-Rinse  
with Add-On Faucet**

- 8" centers
- Add-On Faucet with 12" spout
- ½" NPT female inlets
- 38" high with 15" overhang
- Mounting kit & flexible water lines included

Model  
**DX-109**



**8" Center Wall  
Mount Pre-Rinse  
with Add-On Faucet  
Less Spout**

- 8" centers
- Add-On Faucet less spout
- ½" NPT female inlets
- 38" high with 15" overhang
- Mounting kit & flexible water lines included

Model  
**DX-109-X**



**Single Hole Deck  
Mount Pre-Rinse**

- 1-1/8" OD x 2-1/4" shank
- Fits in 1-1/4" single hole
- 35" high with 15" overhang
- 13" water lines with 3/8" compression fittings

Model  
**DX-202**

# Diamond Series Pre-Rinse Replacement Parts



No.	Model	Description
1	DX-133	44" Hose
2	DX-162	Spring
3	DX-129	1.15 GPM Spray Head
4	DX-171	Spray Head Handle with screws
5	DX-322	Button Valve
6	DX-165	Hook
7	DX-161	Spring Retainer
8	DX-160	18" Riser Pipe
8	DX-160-24	24" Riser Pipe
9	DX-137	Wall Bracket
	DX-166	Repair Kit for Spray Head (Shower Pattern)
	DX-179	Repair Kit for Spray Head (Knife Pattern)

## 1.15 GPM Spray Head

- Dual Spray technology featuring two spray patterns
- Shower Pattern - tight, high-powered shower pattern for tough grime removal
- Knife Pattern - wide, fan-like pattern for large surface area rinsing
- 360° smooth-swivel functionality
- Ergonomic handle
- Durable valve for extended longevity

Model  
DX-129

**DUAL SPRAY**  
TECHNOLOGY



## Add-On Faucets

- 3/8" NPT Male inlet
- 3/8" NPT Female outlet
- Turns on and off without obstruction



Model      Add-On Faucet Spout Size

DX-138    6" Swing Spout

DX-149    8" Swing Spout

DX-139    12" Swing Spout

DX-140    14" Swing Spout

DX-141    16" Swing Spout

DX-1XX    Base Only (No Spout)

## Pre-Rinse Faucet Bases



Model      Description

DX-208    8" Center Pre-Rinse Base

DX-201    Single Hole Pre-Rinse Base

# Diamond Series Faucets

Features apply to all Diamond Series Faucets

- Ultra-polish satin finish on solid brass base
- 1/4 turn high performance stainless steel ceramic cartridge valves w/ integral check
- 1.8 GPM aerator installed
- Durable full range swing spout with double o-ring construction
- Lever handles
- Mounting kit & flexible water lines included



## Single Hole Deck Mount Faucets

- Fits 1-1/4" single hole
- 1-1/8" OD x 2-1/4" shank
- 20" water lines with 3/8" compression fittings

Model	Spout Size
<b>DX-601</b>	6"W Double Bend
<b>DX-602</b>	8-1/2"W Double Bend
<b>DX-625</b>	4-1/2"W Double Bend
<b>DX-6XX</b>	Faucet Body (No Spout)



## 4" Center Deck Mount Faucets

- 1/2" NPS male inlets on 4" centers

Model	Spout Size	Model	Spout Size
<b>DX-306</b>	6" Swing	<b>DX-316</b>	16" Swing
<b>DX-308</b>	8" Swing	<b>DX-301</b>	6"W Double Bend
<b>DX-310</b>	10" Swing	<b>DX-302</b>	8-1/2"W Double Bend
<b>DX-312</b>	12" Swing	<b>DX-325</b>	4-1/2"W Double Bend
<b>DX-314</b>	14" Swing	<b>DX-3XX</b>	Faucet Body (No Spout)



## 4" Center Wall Mount Faucets

- 1/2" NPS male inlets on 4" centers

Model	Spout Size	Model	Spout Size
<b>DX-400</b>	4-1/2"W Double Bend	<b>DX-406</b>	6" Swing
<b>DX-401</b>	6"W Double Bend	<b>DX-408</b>	8" Swing
<b>DX-402</b>	8-1/2"W Double Bend	<b>DX-410</b>	10" Swing
<b>DX-4XX</b>	Faucet Body (No Spout)		



## 8" Center Raised Deck Mount Faucets

- 1/2" NPS male inlets on 8" centers

Model	Spout Size	Model	Spout Size
<b>DX-906</b>	6" Swing	<b>DX-916</b>	16" Swing
<b>DX-908</b>	8" Swing	<b>DX-918</b>	18" Jointed
<b>DX-910</b>	10" Swing	<b>DX-901</b>	6"W Double Bend
<b>DX-912</b>	12" Swing	<b>DX-902</b>	8-1/2"W Double Bend
<b>DX-914</b>	14" Swing	<b>DX-9XX</b>	Faucet Body (No Spout)



## 8" Center Wall Mount Faucets

- 1/2" NPT female inlets on 8" centers

Model	Spout Size	Model	Spout Size
<b>DX-806</b>	6" Swing	<b>DX-816</b>	16" Swing
<b>DX-808</b>	8" Swing	<b>DX-818</b>	18" Jointed
<b>DX-810</b>	10" Swing	<b>DX-801</b>	6"W Double Bend
<b>DX-812</b>	12" Swing	<b>DX-802</b>	8-1/2"W Double Bend
<b>DX-814</b>	14" Swing	<b>DX-8XX</b>	Faucet Body (No Spout)

# Diamond Series Replacement Parts

## Swing Spouts

- Built for high volume
- Double o-ring construction
- Ultra-polish satin finish



Model	Spout Size
<b>DX-420</b>	6" Swing Spout
<b>DX-421</b>	8" Swing Spout
<b>DX-422</b>	10" Swing Spout
<b>DX-423</b>	12" Swing Spout

Model	Spout Size
<b>DX-424</b>	14" Swing Spout
<b>DX-425</b>	16" Swing Spout
<b>DX-426</b>	18" Jointed Spout

## Double Bend Gooseneck Spouts

- Built for high volume
- Double o-ring construction
- Ultra-polish satin finish



Model	Spout Size
<b>DX-430</b>	4-1/2" Double Bend Gooseneck
<b>DX-431</b>	6" Double Bend Gooseneck
<b>DX-432</b>	8-1/2" Double Bend Gooseneck



## 1/4 Turn High Performance Ceramic Cartridge Valves

- Fits all Diamond Series Faucets
- Integral check valve
- Stainless Steel construction
- Fully assembled, easy to install

Model	Description
<b>DX-708</b>	Cold Valve
<b>DX-709</b>	Hot Valve



## Coupling Flanges

- Fits all Diamond Series faucets
- Flange seal technology
- Eccentric fittings
- Includes nipples
- 1/2" NPT female inlet
- 1/4" adjustment per flange
- Two rubber washers



Flange Seal Technology

Model	Description
<b>DX-100</b>	Includes 2 Flanges



## Diamond Series Complete Mounting Kit

- (2) 3/8" Stainless Steel Braided Flexible Supply Hoses, 30"L
- Includes 1/2" NPT Close Elbows w/ Swivel Compression fittings on faucet side & 3/8" Compression fittings on water supply side
- (2) 1/2" NPS Nipples, (2) washers & (2) lock nuts
- No soldering or teflon tape required

Model	Description
<b>21-445L</b>	Diamond Series Mounting Kit

## Diamond Series Electronic Faucets



ADA Compliant

### 4" Center Wall Mount with Satin Finish

- Infrared Sensor Operated
- Battery Powered Control Module, (4) AA Batteries Included, AC Adapter Optional
- Low Battery Indicator Light
- Easy Adjust Shut-Off Delay, Auto Flush, Auto Time-Out and Range Sensitivity
- 2.2 GPM Aerator Installed
- Includes Control Module, Mechanical Mixing Valve & (3) Supply Hoses
- Replacement Spouts available

**Model**  
**16-670**

#### Replacement Spouts

Model	Description
<b>21-433L</b>	4-1/2" Satin Finish Double Bend
<b>21-434L</b>	6-1/2" Satin Finish Double Bend

#### Replacement Aerators

Model	Description
<b>22-671L</b>	1.0 GPM Honeycomb Aerator
<b>22-672L</b>	2.2 GPM Honeycomb Aerator



ADA Compliant

### Single Hole Wall Mount with Satin Finish

- Infrared Sensor Operated
- Battery Powered Control Module, (4) AA Batteries Included, AC Adapter Optional
- Low Battery Indicator Light
- Easy Adjust Shut-Off Delay, Auto Flush, Auto Time-Out and Range Sensitivity
- 1.0 GPM Aerator Installed
- Includes Control Module, Mechanical Mixing Valve & (3) Supply Hoses

**Model**  
**16-675**

## Diamond Series Rotary Twist Waste Valves



**New**

### Stainless Steel Rotary Twist Waste Valves

- Fits 3-1/2" sink opening
- 1-1/4" overflow outlet with cap
- Stainless steel body
- Stainless steel ball valve
- Includes vandal resistant screw for strainer
- Approximately 2-3 times the drain rate of a conventional lever waste drain



Stainless Steel Ball Valve shown half open

Model	Description
<b>22-850</b>	Stainless Steel Rotary Twist Waste Valve
<b>22-851</b>	Short Handle Stainless Steel Rotary Twist Waste Valve

# Royal Series Pre-Rinse Units

**Krowne Royal Series Pre-Rinse** come factory assembled to substantially reduce installation time. Our knife style spray pattern leads the industry in performance and efficiency. We keep a wide range of pre-rinse in stock at all times which are ready to ship same day.

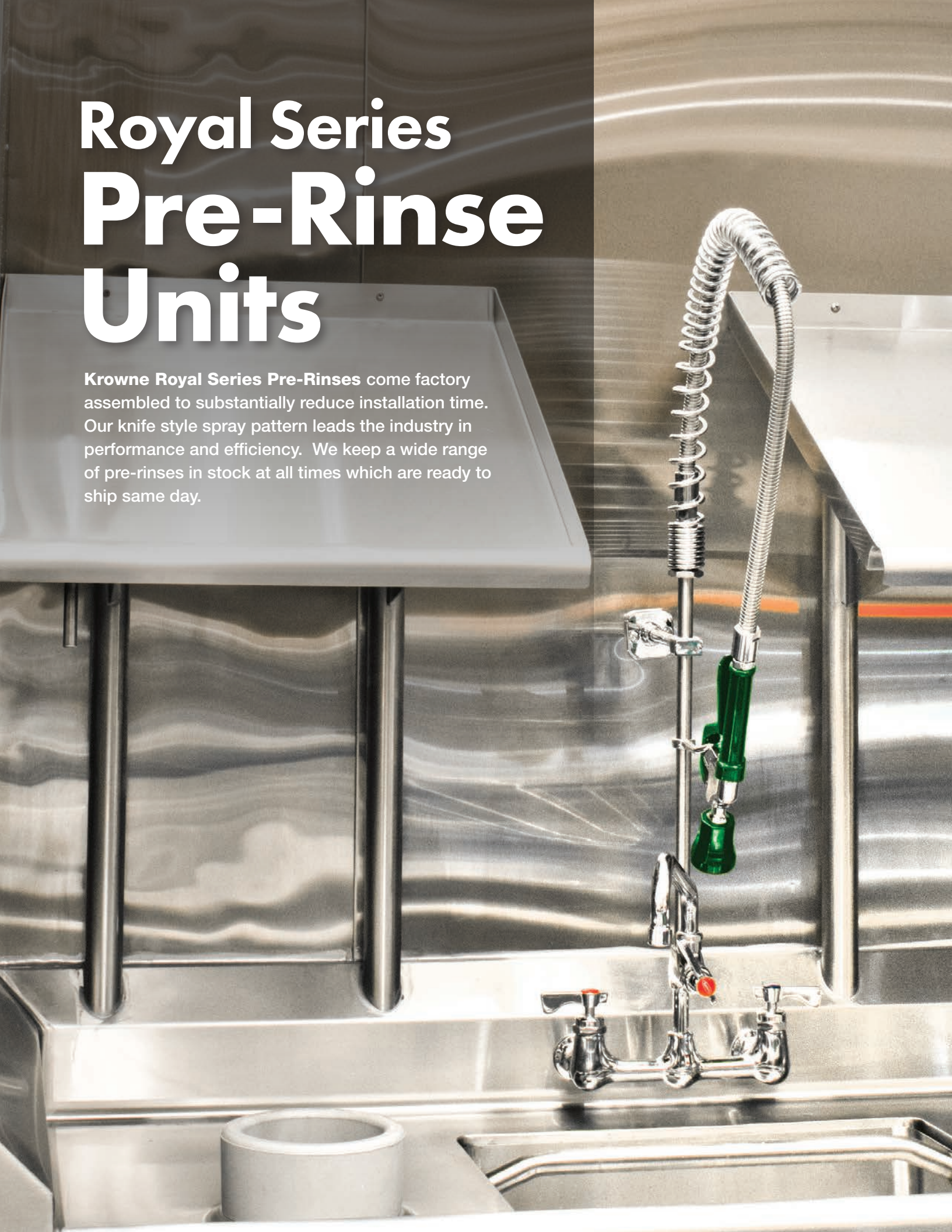



## Pre-Rinse Features

### 1 Stainless Steel Hose

1 High performance radial wrap tubing pressure tested to 400 PSI. Corrugated exterior hose with reinforced inner tube.

### 2 E-Z Install Swivel Fitting

2 Allows for quick installation of pre-rinse without requiring plumber to fully rotate hose while assembling.

### 3 Knife Style Spray Valve

3 High performance valve cleans dishes more efficiently than the traditional shower style pattern sold by most competitors. 1.15 GPM with heat resistant bumper.

### 4 Wall Bracket

4 Secures pre-rinse to wall. Included with all models. Can be cut to desired length.

### 5 Add-On Faucet

5 Allows pre-rinse to double as a faucet. Included with 17-109WL or can be added to any other Krowne Pre-Rinse.

### 6 Ceramic Cartridge Valves

6 High performance 1/4 turn ceramic cartridge valves with integral check designed to last longer than traditional rubber compression valves.

### 7 Offset Flanges

7 Eccentric fittings allow easy alignment adjustments for quick installation.

### 8 Mounting Kit Included

8 Everything needed to mount your pre-rinse is included for ease of installation.



Royal Series Pre-Rinse Units include a 3-year warranty.

# Pre-Rinse Units



## 8" Center Wall Mount Pre-Rinse with Wall Bracket

- Pre-assembled to cut installation time
- Includes wall bracket
- 1/4 Turn high performance ceramic cartridge valves with integral check
- 1/2" NPT female inlets on 8" centers
- 1.15 GPM spray head
- 35" high with 15" overhang
- Mounting kit included
- Solid chrome plated brass base

Model	Case Qty.
17-108WL	3



## 8" Center Wall Mount Pre-Rinse with Wall Bracket & Add-On Faucet (12" Spout)

- Pre-assembled to cut installation time
- Includes wall bracket
- 1/4 Turn high performance ceramic cartridge valves with integral check
- 1/2" NPT female inlets on 8" centers
- 1.8 GPM faucet spout
- 1.15 GPM spray head
- 38" high with 15" overhang
- Mounting kit included
- Solid chrome plated brass base

Model	Case Qty.
17-109WL	3

### Replacement Parts for 17-108WL & 17-109WL

#### 1/4 Turn Ceramic Cartridge Valves

- Fits all Royal Series pre-rinse
- Integral check valve
- Fully assembled, easy to install



Model	Description
21-308L	Cold Valve
21-309L	Hot Valve

#### Spray Head

- Interchangeable with most brands
- Ergonomic design
- 1.15 GPM Knife Pattern



Model
21-129L

#### Pre-Rinse Hose with Grip

- 44" flexible stainless steel hose



Model
21-133L

#### E-Z Install Flexible Water Line Kit

- (2) 3/8" Stainless Steel Braided Flexible Supply Hoses
- Includes 1/2" NPT Close Elbows w/ Swivel Compression fittings on faucet side & 3/8" Compression fittings on water supply side
- 22" L water lines



Model
21-443L

For full Replacement Parts & Accessories, see page 25.

# Pre-Rinse Units



## Single Hole Deck Mount Pre-Rinse with Wall Bracket

- Pre-assembled to cut installation time
- Includes wall bracket
- 1/4 Turn high performance ceramic cartridge valves with integral check
- 1-1/8" OD x 2-1/4" shank; fits 1-1/4" hole
- 20" water lines w/ 3/8" compression fittings
- 1.15 GPM spray head
- 35" high with 15" overhang
- Mounting hardware included
- Solid chrome plated brass base

Model	Case Qty.
17-202WL	3

## Single Hole Deck Mount Pre-Rinse with Wall Bracket

- Pre-assembled to cut installation time
- Includes wall bracket
- 1/4 Turn high performance ceramic cartridge valve with integral check
- 1/2" NPS male inlet
- 1.15 GPM spray head
- 35" high with 15" overhang
- Mounting hardware included
- Solid chrome plated brass base

Model
17-206WL

## Replacement Parts for 17-202WL & 17-206WL

### 1/4 Turn Ceramic Cartridge Valves

- Fits all Royal Series pre-rinse
- Integral check valve
- Fully assembled, easy to install



Model	Description
21-308L	Cold Valve
21-309L	Hot Valve

### Spray Head

- Interchangeable with most brands
- Ergonomic design
- 1.15 GPM Knife Pattern



Model
21-129L

### Pre-Rinse Hose with Grip

- 44" flexible stainless steel hose



Model
21-133L

### 13" Replacement Water Line Kit

- For use on New Style Single Hole Deck Mount Pre-Rinse and Faucets

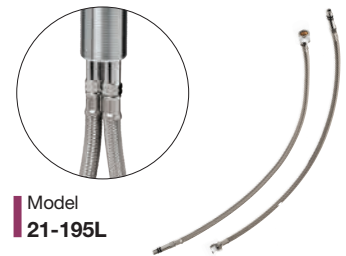

Model
21-195L

For full Replacement Parts & Accessories, see page 25.

## Pre-Rinse Units



### 4" Center Raised Deck Mount Pre-Rinse with Wall Bracket

- Pre-assembled to cut installation time
- Includes wall bracket
- 1/4 Turn high performance ceramic cartridge valves with integral check
- 1/2" NPT female inlets on 4" centers
- 1.15 GPM spray head
- 38" high with 15" overhang
- Mounting kit included
- Solid chrome plated brass base

Model  
**17-204WL**



### 8" Center Raised Deck Mount Pre-Rinse with Wall Bracket

- Pre-assembled to cut installation time
- Includes wall bracket
- 1/4 Turn high performance ceramic cartridge valves with integral check
- 1/2" NPT female inlets on 8" centers
- 1.15 GPM spray head
- 38" high with 15" overhang
- Mounting kit included
- Solid chrome plated brass base

Model  
**17-208WL**

### Replacement Parts for 17-204WL & 17-208WL

#### 1/4 Turn Ceramic Cartridge Valves

- Fits all Royal Series pre-rinse
- Integral check valve
- Fully assembled, easy to install



Model	Description
<b>21-308L</b>	Cold Valve
<b>21-309L</b>	Hot Valve

#### Spray Head

- Interchangeable with most brands
- Ergonomic design
- 1.15 GPM Knife Pattern

Model  
**21-129L**



#### Pre-Rinse Hose with Grip

- 44" flexible stainless steel hose

Model  
**21-133L**



#### 1/2" x 3/8" Braided Supply Hoses

- Includes (2) 3/8" Stainless Steel Braided Flexible Supply Hoses
- 1/2" Female NPT Fittings on faucet side, 3/8" Compression Fittings on supply side
- 24" L water lines

Model  
**21-198L**



For full Replacement Parts & Accessories, see page 25.

# Pre-Rinse Units



## 8" Center Wall Mount Solid Arm Pre-Rinse with Wall Bracket

- 12" Solid swivel arm
- Includes wall bracket
- 1/4 Turn high performance ceramic cartridge valves with integral check
- 1/2" NPT female inlets on 8" centers
- 1.15 GPM spray head
- 30" high with 12" overhang
- Mounting kit included
- Solid chrome plated brass base

Model  
**17-312WL**

### REPLACEMENT PARTS FOR 17-312WL



Replacement Arm  
Model  
**17-310**



24" Hose with Grip  
Model  
**21-181L**



## 4" Center Wall Mount Pre-Rinse with Wall Bracket

- Wall Mount on 4" Centers
- Includes wall bracket
- 1/4 Turn high performance ceramic cartridge valves with integral check
- 1/2" NPS male inlets on 4" centers
- 1.15 GPM spray head
- 35" high with 15" overhang
- Solid chrome plated brass base

Model  
**17-124WL**

### Replacement Parts for 17-312WL & 17-124WL

#### 1/4 Turn Ceramic Cartridge Valves

- Fits all Royal Series pre-rinse
- Integral check valve
- Fully assembled, easy to install



Model	Description
<b>21-308L</b>	Cold Valve
<b>21-309L</b>	Hot Valve

#### Spray Head

- Interchangeable with most brands
- Ergonomic design
- 1.15 GPM Knife Pattern



Model  
**21-129L**

#### Pre-Rinse Hose with Grip

- 44" flexible stainless steel hose



Model  
**21-133L**

#### E-Z Install Flexible Water Line Kit

- (2) 3/8" Stainless Steel Braided Flexible Supply Hoses
- Includes 1/2" NPT Close Elbows w/ Swivel Compression fittings on faucet side & 3/8" Compression fittings on water supply side
- 22"L water lines



Model  
**21-443L**

For full Replacement Parts & Accessories, see page 25.

# ShelfMaster Pre-Rinse

## 8" Center Wall Mount ShelfMaster Pre-Rinse with Wall Bracket and Add-On Faucet (12" Spout)

- Designed to fit under shelf without sacrificing reach
- Includes wall bracket
- ¼ Turn high performance ceramic cartridge valves with integral check
- ½" NPT female inlets on 8" centers
- Stainless steel chemical rigid tee connector
- 1.15 GPM spray head
- 1.8 GPM faucet spout
- 23-3/4"H with 15" overhang
- Includes 8" Riser (3" Riser optional)
- Mounting kit included
- Solid chrome plated brass base

Model  
**18-725L**



Ceramic Cartridge Valves



Offset Flanges



Optional Chemical Rigid Tee Adapter and optional 3" Riser

## Chemical Rigid Tee Assembly

- Fits most manufacturers
- Installs on Pre-Rinse bases
- 3/8" NPT Close Nipple
- 3/8" NPT Female Thread
- 3/8" NPT Tee Fitting on side
- Chrome Plated Brass

Model  
**21-545L**



## REPLACEMENT PARTS & ACCESSORIES



Model  
**21-308L**

Cold 1/4 Turn Ceramic Cartridge Valve



Model  
**21-309L**

Hot 1/4 Turn Ceramic Cartridge Valve



Model  
**21-181L**

24" Hose with Grip



Model  
**21-670**

Shelfmaster Spring



Model  
**21-129L**

1.15 GPM Spray Head



Model  
**21-198L**

1/2" x 3/8" Braided Supply Hoses

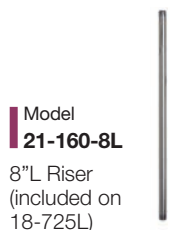

Model  
**21-160-8L**

8" Riser (included on 18-725L)



Model  
**21-160-3L**

3" Riser



Model  
**21-179L**

Spray Head Repair Kit

# Space Saver Pre-Rinse

## Features apply to all Space Saver Pre-Rinse Units

- Pre-assembled to cut installation time
- Includes Wall Bracket & Add-On Faucet
- ¼ Turn high performance ceramic cartridge valves with integral check
- 1.15 GPM spray head
- 1.8 GPM faucet spout
- Mounting kit included
- Solid chrome plated brass base



### 4" Center Raised Deck Mount Space Saver Pre-Rinse

with Wall Bracket & Add-On Faucet

- 4" centers
- ½" NPT female inlets
- 24-7/8" high with 8" overhang

Model	Spout Size
<b>18-406L</b>	6" Swing Spout
<b>18-408L</b>	8" Swing Spout

18-408L



### Single Hole Deck Mount Space Saver Pre-Rinse

with Wall Bracket & Add-On Faucet

- Fits 1-1/4" single hole
- 1-1/8" OD x 2-1/4" shank
- 20" Water lines with 3/8" compression fittings
- 25-1/4" high with 8" overhang

Model	Spout Size
<b>18-506L</b>	6" Swing Spout
<b>18-508L</b>	8" Swing Spout

18-508L

### 8" Center Raised Deck Mount Space Saver Pre-Rinse

with Wall Bracket & Add-On Faucet

- 8" centers
- ½" NPT female inlets
- 24-7/8" high with 8" overhang

Model	Spout Size
<b>18-606L</b>	6" Swing Spout
<b>18-608L</b>	8" Swing Spout



18-608L

### 8" Center Wall Mount Space Saver Pre-Rinse

with Wall Bracket & Add-On Faucet

- 8" centers
- ½" NPT female inlets
- 22-1/2" high with 8" overhang

Model	Spout Size
<b>18-706L</b>	6" Swing Spout
<b>18-708L</b>	8" Swing Spout



18-708L

## REPLACEMENT PARTS & ACCESSORIES



Model **21-308L**  
Cold 1/4 Turn Ceramic Cartridge Valve



Model **21-309L**  
Hot 1/4 Turn Ceramic Cartridge Valve



Model **21-181L**  
24" Hose for Space Saver Pre-Rinse



Model **21-163**  
Spring for Space Saver Pre-Rinse



Model **21-129L**  
Spray Head (1.15 GPM)



Model **21-160-8L**  
8" L Riser for Space Saver Pre-Rinse



Model **21-443L**  
E-Z Install Flexible Water Line Kit

# Pre-Rinse Replacement Parts

Interchangeable with most brands



No.	Model	Description
1	21-137	Wall Bracket
2	21-168	Riser (12" Long, 3/8" male thread)
2	21-160L	Riser (18" Long, 3/8" male thread)
2	21-160-24L	Riser (24" Long, 3/8" male thread)
3	21-161L	Spring Retainer
4	21-162	24" Spring
5	21-133L	44" Hose Assembly
6	21-164L	Grip (1/2" NPS Male)
7	21-165	Hook/Screw Assembly
8	21-129L	Complete Pre-Rinse Spray Valve
9	21-171	Spray Head Handle
10	21-170	Ring (Optional)
11	21-302L	Button Valve
12	21-179L	Spray Head Repair Kit - New Style (2007 to present)
13	21-166L	Spray Head Repair Kit - Old Style (Prior to 2007)

Spray Head Repair Kit (New Style 2007 to Present)



12 Model 21-179L

Spray Head Repair Kit (Old Style prior to 2007)



13 Model 21-166L

## Replacement Pre-Rinse Bases



No.	Model	Description
1	21-108L	8" Center Wall Base
2	21-101L	Single Wall Base

No.	Model	Description
3	21-208L	8" Center Deck Base
4	21-202L	Single Hole Deck Base

No.	Model	Description
5	21-204L	4" Center Deck Base
6	21-201L	Single Deck Base



# Pre-Rinse Replacement Parts

## Spray Head

- Interchangeable with most brands
- Ergonomic design
- Full replacement parts available
- Water saving spray head available

Model	Description
<b>21-129L</b>	1.15 GPM Knife Pattern
<b>21-127L</b>	0.65 GPM Knife Pattern



## Knife Style Spray Valve

High performance valve cleans dishes more efficiently than the traditional shower style pattern sold by most competitors. 1.15 GPM with heat resistant bumper.

## Replacement Parts

Model	Description
<b>21-148</b>	Bumper
<b>21-184L</b>	Knife Pattern Brass Nozzle (0.65 GPM)
<b>21-185L</b>	Shower Pattern Brass Nozzle (1.15 GPM)
<b>21-302L</b>	Button Valve Repair Kit



## Pre-Rinse Hose with Grip

- Interchangeable with most brands
- Flexible stainless steel hose

Model	Hose Length	Case Qty.
<b>21-181L</b>	24"L	<b>12</b>
<b>21-133L</b>	44"L	<b>12</b>
<b>21-134L</b>	60"L	<b>12</b>
<b>21-135L</b>	72"L	<b>12</b>
<b>21-136L</b>	96"L	<b>12</b>

## Swivel Pre-Rinse Hose Connector

- Allows spray head to turn 360°
- Reduces stress on hose



**Model**  
**21-547L**

## Add-On Faucets

- Interchangeable with most brands
- Turns on and off without obstruction
- 3/8" NPT Male inlet
- 3/8" NPT Female outlet



**Case Quantity: 12**

Model	Description
<b>21-138L</b>	Add-On Faucet with 6" Spout
<b>21-149L</b>	Add-On Faucet with 8" Spout
<b>21-139L</b>	Add-On Faucet with 12" Spout
<b>21-140L</b>	Add-On Faucet with 14" Spout
<b>21-141L</b>	Add-On Faucet with 16" Spout
<b>21-1XXL</b>	Add-On Faucet (No Spout)

## Pre-Rinse Less Body with Wall Bracket

- Pre-assembled to cut installation time
- Includes wall bracket
- 1.15 GPM spray head
- 35" high with 15" overhang



**Model**  
**17-XXXL**

## Shower Pattern Spray Head

- Interchangeable with most brands
- Different flow rates available
- Full replacement parts available



Model	Description
<b>21-130L</b>	1.15 GPM Spray Head
<b>21-145</b>	1.15 GPM Spray Face
<b>21-142</b>	Replacement Bumper

## Angled Pre-Rinse Spray Head

- Interchangeable with most brands
- Reinforced spray head
- Full repair kits available



Model	Description
<b>21-131L</b>	3.18 GPM Spray Head
<b>21-302L</b>	Button Valve Repair Kit
<b>21-142</b>	Replacement Bumper
<b>21-143</b>	3.18 GPM Spray Face

## Pot Filler Spray Head

- Interchangeable with most brands
- Reinforced spray head
- Full repair kits available



Model	Description
<b>21-132L</b>	Pot Filler Spray Head
<b>21-302L</b>	Button Valve Repair Kit



# Royal Series Plumbing

**Krowne Royal Series Faucets** are meticulously designed for exceptional durability in the most demanding commercial environments. They are used in grocery, retail, bars, restaurants, healthcare, education and hospitality. Every Royal Series faucet includes the components needed for a quick and efficient install.



14-410L



14-400L

### 4" Center Wall Mount Faucets

- ¼ Turn high performance ceramic cartridge valves with integral check
- ½" NPS male inlets on 4" centers
- 1.8 GPM aerator installed
- Durable full range swing spout with double o-ring construction
- Lever handles
- Solid chrome plated brass base

#### Faucets

Model	Spout Size	Case Qty
14-406L	6" Swing Spout	12
14-408L	8" Swing Spout	12
14-410L	10" Swing Spout	12
14-400L	3-1/2" Wide Gooseneck Spout (0.5 GPM)	12
14-401L	6" Wide Gooseneck Spout	12
14-402L	8-1/2" Wide Gooseneck Spout	12
14-4XXL	Faucet Body (No Spout)	12

#### Replacement Parts

Model	Description
21-308L	Cold 1/4 Turn Ceramic Cartridge Valve
21-309L	Hot 1/4 Turn Ceramic Cartridge Valve
21-443L	E-Z Install Flexible Water Line Kit

For spout and aerator options see pages 41 & 45



14-400L-W-E2

### 4" Center Wall Mount Faucets with Wrist Blade Handles

- ¼ Turn high performance ceramic cartridge valves with integral check
- ½" NPS male inlets on 4" centers
- 1.5 GPM aerator installed
- Durable full range swing spout with double o-ring construction
- Vandal resistant wrist blade handles
- Solid chrome plated brass base

#### Replacement Parts

Model	Description
21-308L	Cold 1/4 Turn Ceramic Cartridge Valve
21-309L	Hot 1/4 Turn Ceramic Cartridge Valve
21-443L	E-Z Install Flexible Water Line Kit
21-311	Wrist Blade Handle Kit

#### Faucets

Model	Spout Size	Case Qty
14-406L-W-E4	6" Swing Spout	-
14-410L-W-E4	10" Swing Spout	-
14-400L-W-E2	3-1/2" Wide Gooseneck Spout (0.5 GPM)	-
14-401L-W-E4	6" Wide Gooseneck Spout	-
14-4XXL-W	Faucet Body (No Spout)	12

## 8" Center Wall Mount Faucets

- ¼ Turn high performance ceramic cartridge valves with integral check
- ½" NPT female inlets on 8" centers
- 1.8 GPM aerator installed
- Durable full range swing spout with double o-ring construction
- Lever handles
- Mounting kit included
- Solid chrome plated brass base

Faucets		
Model	Spout Size	Case Qty
14-806L	6" Swing Spout	6
14-808L	8" Swing Spout	6
14-810L	10" Swing Spout	6
14-812L	12" Swing Spout	6
14-814L	14" Swing Spout	6
14-816L	16" Swing Spout	6
14-818L	18" Jointed Spout	6
14-824L	24" Jointed Spout	6
14-801L	6" Wide Gooseneck Spout	6
14-802L	8-1/2" Wide Gooseneck Spout	6
14-8XXL	Faucet Body (No Spout)	6



1.8 GPM Aerator

Ceramic Cartridge Valves

Offset Flanges



14-801L



14-812L

### Replacement Parts

Model	Description
21-308L	Cold 1/4 Turn Ceramic Cartridge Valve
21-309L	Hot 1/4 Turn Ceramic Cartridge Valve
21-443L	E-Z Install Flexible Water Line Kit
21-311	Wrist Blade Handle Kit

For spout and aerator options see pages 41 & 45

## 8" Center Wall Mount Faucets with Wrist Blade Handles

- ¼ Turn high performance ceramic cartridge valves with integral check
- ½" NPT female inlets on 8" centers
- 1.5 GPM aerator installed
- Durable full range swing spout with double o-ring construction
- Vandal resistant wrist blade handles
- Mounting kit included
- Solid chrome plated brass base

Faucets		
Model	Spout Size	Case Qty.
14-808L-W-E4	8" Swing Spout	-
14-812L-W-E4	12" Swing Spout	-
14-801L-W-E4	6" Wide Gooseneck Spout	-
14-802L-W-E4	8-1/2" Wide Gooseneck Spout	-
14-8XXL-W	Faucet Body (No Spout)	6



14-802L-W-E4

### Replacement Parts

Model	Description
21-308L	Cold 1/4 Turn Ceramic Cartridge Valve
21-309L	Hot 1/4 Turn Ceramic Cartridge Valve
21-443L	E-Z Install Flexible Water Line Kit

For spout and aerator options see pages 41 & 45

## 4" Center Deck Mount Faucets

- ¼ Turn high performance ceramic cartridge valves with integral check
- ½" NPS male inlets on 4" centers
- 1.8 GPM aerator installed
- Durable full range swing spout with double o-ring construction
- Lever handles
- Solid chrome plated brass base



15-308L



15-301L

### Faucets

Model	Spout Size	Case Qty
15-306L	6" Swing Spout	12
15-308L	8" Swing Spout	12
15-310L	10" Swing Spout	12
15-312L	12" Swing Spout	12
15-314L	14" Swing Spout	12
15-316L	16" Swing Spout	12
15-325L	3-1/2" Wide Gooseneck Spout (0.5 GPM)	12
15-301L	6" Wide Gooseneck Spout	12
15-302L	8-1/2" Wide Gooseneck Spout	12
15-350L	6" Swing Spout w/ Hose Adapter	-
15-3XXL	Faucet Body (No Spout)	12

### Replacement Parts

Model	Description
21-308L	Cold 1/4 Turn Ceramic Cartridge Valve
21-309L	Hot 1/4 Turn Ceramic Cartridge Valve
21-198L	1/2" x 3/8" Braided Supply Hoses

For spout and aerator options see pages 41 & 45

## 4" Center Deck Mount Faucets with Wrist Blade Handles

- ¼ Turn high performance ceramic cartridge valves with integral check
- ½" NPS male inlets on 4" centers
- 1.5 GPM aerator installed
- Durable full range swing spout with double o-ring construction
- Vandal resistant wrist blade handles
- Solid chrome plated brass base



15-301L-W-E4

### Faucets

Model	Spout Size	Case Qty.
15-308L-W-E4	8" Swing Spout	-
15-312L-W-E4	12" Swing Spout	-
15-325L-W-E2	3-1/2" Wide Gooseneck Spout (0.5 GPM)	-
15-301L-W-E4	6" Wide Gooseneck Spout	-
15-3XXL-W	Faucet Body (No Spout)	12

### Replacement Parts

Model	Description
21-308L	Cold 1/4 Turn Ceramic Cartridge Valve
21-309L	Hot 1/4 Turn Ceramic Cartridge Valve
21-198L	1/2" x 3/8" Braided Supply Hoses
21-311	Wrist Blade Handle Kit

For spout and aerator options see pages 41 & 45

## 8" Center Deck Mount Faucets

- ¼ Turn high performance ceramic cartridge valves with integral check
- ½" NPS male inlets on 8" centers
- 1.8 GPM aerator installed
- Durable full range swing spout with double o-ring construction
- Lever handles
- Solid chrome plated brass base



15-510L



15-501L

### Faucets

Model	Spout Size	Case Qty
15-506L	6" Swing Spout	-
15-508L	8" Swing Spout	12
15-510L	10" Swing Spout	-
15-512L	12" Swing Spout	12
15-514L	14" Swing Spout	-
15-516L	16" Swing Spout	12
15-525L	3-1/2" Wide Gooseneck Spout (0.5 GPM)	-
15-501L	6" Wide Gooseneck Spout	-
15-502L	8-1/2" Wide Gooseneck Spout	12
15-5XXL	Faucet Body (No Spout)	12

### Replacement Parts

Model	Description
21-308L	Cold 1/4 Turn Ceramic Cartridge Valve
21-309L	Hot 1/4 Turn Ceramic Cartridge Valve
21-198L	1/2" x 3/8" Braided Supply Hoses

For spout and aerator options see pages 41 & 45

## 8" Center Deck Mount Faucets with Wrist Blade Handles

- ¼ Turn high performance ceramic cartridge valves with integral check
- ½" NPS male inlets on 8" centers
- 1.5 GPM aerator installed
- Durable full range swing spout with double o-ring construction
- Vandal resistant wrist blade handles
- Solid chrome plated brass base



15-501L-W-E4

### Faucets

Model	Spout Size	Case Qty.
15-508L-W-E4	8" Swing Spout	-
15-512L-W-E4	12" Swing Spout	-
15-525L-W-E2	3-1/2" Wide Gooseneck Spout (0.5 GPM)	-
15-501L-W-E4	6" Wide Gooseneck Spout	-
15-5XXL-W	Faucet Body (No Spout)	12

### Replacement Parts

Model	Description
21-308L	Cold 1/4 Turn Ceramic Cartridge Valve
21-309L	Hot 1/4 Turn Ceramic Cartridge Valve
21-198L	1/2" x 3/8" Braided Supply Hoses
21-311	Wrist Blade Handle Kit

For spout and aerator options see pages 41 & 45

## 4" Center Raised Deck Mount Faucets

- ¼ Turn high performance ceramic cartridge valves with integral check
- ½" NPT female inlets on 4" centers
- 1.8 GPM aerator installed
- Durable full range swing spout with double o-ring construction
- Lever handles
- Mounting kit included
- Solid chrome plated brass base



15-410L



15-425L

### Faucets

Model	Spout Size
15-406L	6" Swing Spout
15-408L	8" Swing Spout
15-410L	10" Swing Spout
15-412L	12" Swing Spout
15-414L	14" Swing Spout
15-418L	18" Jointed Spout
15-425L	3-1/2" Wide Gooseneck Spout (0.5 GPM)
15-401L	6" Wide Gooseneck Spout
15-402L	8-1/2" Wide Gooseneck Spout
15-4XXL	Faucet Body (No Spout)

### Replacement Parts

Model	Description
21-308L	Cold 1/4 Turn Ceramic Cartridge Valve
21-309L	Hot 1/4 Turn Ceramic Cartridge Valve
21-198L	1/2" x 3/8" Braided Supply Hoses

For spout and aerator options see pages 41 & 45

## 4" Center Raised Deck Mount Faucets with Wrist Blade Handles

- ¼ Turn high performance ceramic cartridge valves with integral check
- ½" NPT female inlets on 4" centers
- 1.5 GPM aerator installed
- Durable full range swing spout with double o-ring construction
- Vandal resistant wrist blade handles
- Mounting kit included
- Solid chrome plated brass base



15-425L-W-E2

### Faucets

Model	Spout Size
15-408L-W-E4	8" Swing Spout
15-412L-W-E4	12" Swing Spout
15-425L-W-E2	3-1/2" Wide Gooseneck Spout (0.5 GPM)
15-401L-W-E4	6" Wide Gooseneck Spout
15-4XXL-W	Faucet Body (No Spout)

### Replacement Parts

Model	Description
21-308L	Cold 1/4 Turn Ceramic Cartridge Valve
21-309L	Hot 1/4 Turn Ceramic Cartridge Valve
21-198L	1/2" x 3/8" Braided Supply Hoses
21-311	Wrist Blade Handle Kit

For spout and aerator options see pages 41 & 45

## 8" Center Raised Deck Mount Faucets

- ¼ Turn high performance ceramic cartridge valves with integral check
- ½" NPT female inlets on 8" centers
- 1.8 GPM aerator installed
- Durable full range swing spout with double o-ring construction
- Lever handles
- Mounting kit included
- Solid chrome plated brass base



15-810L



15-801L

### Faucets

Model	Spout Size
15-806L	6" Swing Spout
15-808L	8" Swing Spout
15-810L	10" Swing Spout
15-812L	12" Swing Spout
15-814L	14" Swing Spout
15-818L	18" Swing Spout
15-825L	3-1/2" Wide Gooseneck Spout (0.5 GPM)
15-801L	6" Wide Gooseneck Spout
15-802L	8-1/2" Wide Gooseneck Spout
15-8XXL	Faucet Body (No Spout)

### Replacement Parts

Model	Description
21-308L	Cold 1/4 Turn Ceramic Cartridge Valve
21-309L	Hot 1/4 Turn Ceramic Cartridge Valve
21-198L	1/2" x 3/8" Braided Supply Hoses

For spout and aerator options see pages 41 & 45

## 8" Center Raised Deck Mount Faucets with Wrist Blade Handles

- ¼ Turn high performance ceramic cartridge valves with integral check
- ½" NPT female inlets on 8" centers
- 1.5 GPM aerator installed
- Durable full range swing spout with double o-ring construction
- Vandal resistant wrist blade handles
- Mounting kit included
- Solid chrome plated brass base



15-801-W-E4

### Faucets

Model	Spout Size
15-808L-W-E4	8" Swing Spout
15-812L-W-E4	12" Swing Spout
15-825L-W-E2	3-1/2" Wide Gooseneck Spout (0.5 GPM)
15-801L-W-E4	6" Wide Gooseneck Spout
15-8XXL-W	Faucet Body (No Spout)

### Replacement Parts

Model	Description
21-308L	Cold 1/4 Turn Ceramic Cartridge Valve
21-309L	Hot 1/4 Turn Ceramic Cartridge Valve
21-198L	1/2" x 3/8" Braided Supply Hoses
21-311	Wrist Blade Handle Kit

For spout and aerator options see pages 41 & 45



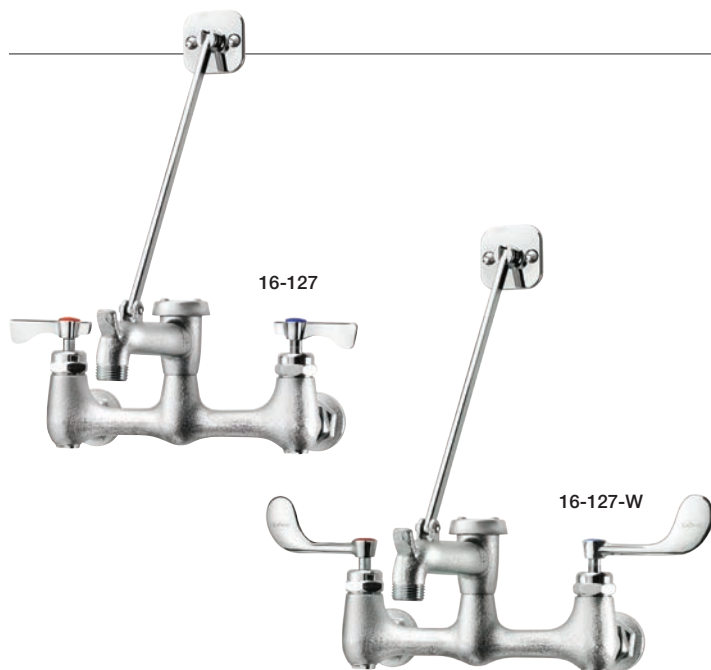

Pail Hook & Hose Threads



Vacuum Breaker



Integral Stops

## Service Sink Faucet with Cast Spout

- Heavy duty flanges with eccentric fittings for quick installations
- Includes wall bracket for spout support
- ¼ Turn high performance ceramic cartridge valves with integral check
- ½" NPT male inlets on 8" centers
- 6-1/2" heavy cast spout with pail hook and hose thread
- Mounting kit included
- Solid rough chrome brass base

### Faucets

Model	Spout Size
<b>16-127</b>	Service Sink Faucet with Lever Handles
<b>16-127-W</b>	Service Sink Faucet with Wrist Blade Handles

**16-127 Case Quantity: 6**

### Replacement Parts

Model	Description
<b>21-308L</b>	Cold 1/4 Turn Ceramic Cartridge Valve
<b>21-309L</b>	Hot 1/4 Turn Ceramic Cartridge Valve
<b>16-128</b>	Replacement Wall Bracket for 16-127
<b>16-129</b>	Vacuum Breaker Repair Kit
<b>21-311</b>	Wrist Blade Handle Kit
<b>21-443L</b>	E-Z Install Flexible Water Line Kit



MS-2424

## Floor Mop Sink

- MS-2424 Bowl Size: 21" x 21" x 9"
- MS-1818 Bowl Size: 15" x 15" x 9"
- 3-1/2" drain w/ 2" IPS outlet
- 18 gauge stainless steel
- Mounting hardware included

Model	Overall Size
<b>MS-2424</b>	24" x 24" x 13"
<b>MS-1818</b>	18" x 18" x 13"

### Replacement Parts

Model	Description
<b>23-145</b>	Replacement Drain

## Mop Hangers

- Stainless steel construction with spring action grips
- MH-24 size: 23"L x 4-1/2"H
- MH-5 size: 5"L x 4-1/2"H
- MH-5 includes 30" rubber hose with 3/4" garden hose inlet



MH-24



MH-5

Model	Description
<b>MH-24</b>	Mop Hanger with 3 Grips
<b>MH-5</b>	Mop Hanger with 1 Grip (Includes hose)



15-350L

## 4" Center Deck Mount Laundry Tub Faucet

- ¼ Turn high performance ceramic cartridge valves with integral check
- ½" NPS male inlets on 4" centers
- 1.8 GPM aerator installed on 15-306L, Garden hose adapter installed on 15-350L
- Durable full range swing spout with double o-ring construction
- Lever handles
- Solid chrome plated brass base

Model	Spout Size
<b>15-306L</b>	6" Swing Spout
<b>15-350L</b>	6" Swing Spout with Garden Hose Adapter

## Adjustable Centers Wall Mount Faucet

- ¼ Turn high performance ceramic cartridge valves with integral check
- 2-1/4" – 8-1/4" adjustable centers
- 1/2" NPT female inlets
- 1.8 GPM aerator installed
- Durable full range swing spout with double o-ring construction
- Lever handles
- Mounting kit included
- Solid chrome plated brass base

### Faucets

Model	Spout Size
15-612L	12" Swing Spout
15-625L	3-1/2" Wide Gooseneck Spout (0.5 GPM)
15-601L	6" Wide Gooseneck Spout



15-601L

### Replacement Parts

Model	Description
21-308L	Cold 1/4 Turn Ceramic Cartridge Valve
21-309L	Hot 1/4 Turn Ceramic Cartridge Valve
21-443L	E-Z Install Flexible Water Line Kit

For spout and aerator options see pages 41 & 45



15-612L

## 8" Wall Mount Full Flow Faucet

- ¼ Turn high performance ceramic cartridge valves
- 3/4" NPT female inlets on 8" centers
- Durable full range swing spout with double o-ring construction
- Cross handles
- Mounting kit included
- Solid chrome plated brass base

### Faucets

Model	Spout Size
18-812L	12" Full Flow Spout
18-814L	14" Full Flow Spout



18-812L

### Replacement Parts

Model	Description
21-350L	Cold 1/4 Turn Ceramic Cartridge Valve
21-351L	Hot 1/4 Turn Ceramic Cartridge Valve
21-458L	Replacement 6" Spout
21-460L	Replacement 12" Spout
21-461L	Replacement 14" Spout
21-463L	Replacement 18" Spout



Cross Handle



Full Flow Outlet



3/4" Inlets

## 8" Wall Mount Pot Filler Faucet

- ¼ Turn high performance ceramic cartridge valves with integral check
- ½" NPT female inlets on 8" centers
- Full flow w/cross handle shut-off at end of spout
- Durable full range swing spout with double o-ring construction
- Lever handles
- Mounting kit included
- Solid chrome plated brass base



### Faucets

Model	Spout Size
16-250L	6" Swing Spout
16-251L	12" Jointed Spout
16-252L	18" Jointed Spout
16-253L	24" Jointed Spout

### Replacement Parts

Model	Description
21-308L	Cold 1/4 Turn Ceramic Cartridge Valve
21-309L	Hot 1/4 Turn Ceramic Cartridge Valve
21-441L	12" Pot Filler Spout w/ Shut-Off Valve
21-442L	6" Pot Filler Spout w/ Shut-Off Valve
21-443L	E-Z Install Flexible Water Line Kit

## Single Hole Wall Mount Pot Filler Faucet

- Single hole, single temp
- ¼ Turn high performance ceramic cartridge valve with integral check
- ½" NPS male inlet
- Full flow w/cross handle shut-off at end of spout
- Durable full range swing spout with double o-ring construction
- Lever handle
- Solid chrome plated brass base



### Faucets

Model	Spout Size
16-178L	6" Swing Spout
16-179L	12" Jointed Spout
16-181L	18" Jointed Spout
16-182L	24" Jointed Spout

### Replacement Parts

Model	Description
21-308L	Cold 1/4 Turn Ceramic Cartridge Valve
21-309L	Hot 1/4 Turn Ceramic Cartridge Valve
21-441L	12" Pot Filler Spout w/ Shut-Off Valve
21-442L	6" Pot Filler Spout w/ Shut-Off Valve

## Single Hole Deck Mount Pot Filler Faucet

- Single hole, single temp
- ¼ Turn high performance ceramic cartridge valve with integral check
- ½" NPS male inlet
- Full flow w/cross handle shut-off at end of spout
- Durable full range swing spout with double o-ring construction
- Lever handle
- Solid chrome plated brass base



### Faucets

Model	Spout Size
16-160L	6" Swing Spout
16-161L	12" Jointed Spout
16-162L	18" Jointed Spout
16-163L	24" Jointed Spout

### Replacement Parts

Model	Description
21-308L	Cold 1/4 Turn Ceramic Cartridge Valve
21-309L	Hot 1/4 Turn Ceramic Cartridge Valve
21-441L	12" Pot Filler Spout w/ Shut-Off Valve
21-442L	6" Pot Filler Spout w/ Shut-Off Valve

## Single Hole Wall Mount Faucet

- Single hole, single temp
- ¼ Turn high performance ceramic cartridge valve with integral check
- ½" NPS male inlets
- 1.8 GPM aerator installed
- Durable full range swing spout with double o-ring construction
- Lever handle
- Solid chrome plated brass base



### Faucets

Model	Spout Size
<b>16-170L</b>	6" Swing Spout
<b>16-171L</b>	12" Swing Spout

### Replacement Parts

Model	Description
<b>21-308L</b>	Cold 1/4 Turn Ceramic Cartridge Valve
<b>21-309L</b>	Hot 1/4 Turn Ceramic Cartridge Valve

For spout and aerator options see pages 41 & 45

## Single Hole Wall Mount Remote Spout

- Controlled by foot or knee valve
- ½" NPS male inlet, single hole
- 1.8 GPM aerator installed
- Durable full range swing spout with double o-ring construction
- Solid chrome plated brass base



### Faucets

Model	Spout Size
<b>16-140L</b>	3-1/2" Wide Gooseneck Spout (0.5 GPM)
<b>16-141L</b>	6" Swing Spout
<b>16-142L</b>	8" Swing Spout
<b>16-143L</b>	10" Swing Spout

For spout and aerator options see pages 41 & 45

## Single Hole Deck Mount Remote Spout

- Controlled by foot or knee valve
- ½" NPS male inlet
- 1.8 GPM aerator installed
- Durable full range swing spout with double o-ring construction
- Solid chrome plated brass base



### Faucets

Model	Spout Size
<b>16-130L</b>	3-1/2" Wide Gooseneck Spout (0.5 GPM)
<b>16-131L</b>	6" Swing Spout
<b>16-132L</b>	8" Swing Spout
<b>16-133L</b>	10" Swing Spout

For spout and aerator options see pages 41 & 45

## Single Hole Deck Mount Pantry Faucet

- Single hole, single temp
- ¼ Turn high performance ceramic cartridge valve with integral check
- ½" NPS male inlet
- 1.8 GPM aerator installed
- Durable full range swing spout with double o-ring construction
- Lever handle
- Solid chrome plated brass base



### Faucets

Model	Spout Size
16-200L	6" Swing Spout
16-201L	12" Swing Spout
16-202L	3-1/2" Wide Gooseneck Spout (0.5 GPM)
16-203L	6" Gooseneck Spout

### Replacement Parts

Model	Description
21-308L	Cold 1/4 Turn Ceramic Cartridge Valve
21-309L	Hot 1/4 Turn Ceramic Cartridge Valve

For spout and aerator options see pages 41 & 45

## Single Hole Deck Mount Pantry Faucet

- ¼ Turn high performance ceramic cartridge valve with integral check
- 1-1/8" OD x 2-1/4" shank; fits 1-1/4" hole
- 20" water lines with 3/8" compression fittings
- 1.8 GPM aerator installed
- Durable full range swing spout with double o-ring construction
- Lever handles
- Solid chrome plated brass base



### Faucets

Model	Spout Size
16-306L	6" Swing Spout
16-312L	12" Swing Spout
16-301L	6" Wide Gooseneck Spout
16-302L	8-1/2" Wide Gooseneck Spout



### 13" Replacement Water Line Kit

- For use on New Style Single Hole Deck Mount Pre-Rinses and Faucets

Model  
21-195L

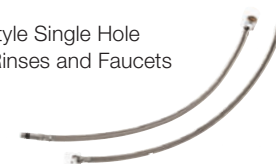

## Single Lever Deck Mount Remote Valve with Remote Spout

- Deck mounted control base with ½" NPS female outlet
- Ceramic cartridge valve with built-in temperature limit stop
- Pre-installed water lines with 3/8" compression female inlets
- Single lever handle
- Color coded index
- Solid chrome plated brass
- ADA Compliant



### Faucets

Model	Description
16-330L	Remote Valve with 3-1/2" Remote Gooseneck Spout
16-331L	Remote Valve with 6" Remote Swing Spout
16-332L	Remote Valve with 8" Remote Swing Spout
16-333L	Remote Valve with 10" Remote Swing Spout
16-33XL	Remote Valve Only

### Replacement Parts

Model	Description
21-345L	Single Lever Ceramic Valve Repair Kit
21-346L	Single Lever Handle Repair Kit
21-198L	1/2" x 3/8" Braided Supply Hoses

## EZ-Install Water Line Kits

### E-Z Install Flexible Water Line Kit

- (2) 3/8" Stainless Steel Braided Flexible Supply Hoses
- Includes 1/2" NPT Close Elbows w/ Swivel Compression fittings on faucet side & 3/8" Compression fittings on water supply side
- 22"L water lines
- No soldering or thread sealant tape required



Model  
21-443L



### E-Z Install Flexible Water Line Kit with Mounting Hardware

- (2) 3/8" Stainless Steel Braided Flexible Supply Hoses
- Includes 1/2" NPT Close Elbows w/ Swivel Compression fittings on faucet side & 3/8" Compression fittings on water supply side
- (2) 1/2" NPS Nipples, (2) washers & (2) lock nuts
- 30"L water lines
- No soldering or thread sealant tape required



Model  
21-445L

### E-Z Install Straight Copper Water Line Kit

- (2) 3/8" Straight Copper Water Lines
- Includes 1/2" NPT Close Elbows w/ Swivel Compression fittings on faucet side
- 14"L water lines
- No soldering or thread sealant tape required on faucet side



Model  
21-440L

### High Volume E-Z Install Flexible Water Line Kit

- (2) 1/2" Stainless Steel Braided Flexible Supply Hoses
- Includes 1/2" NPT Close Elbows w/ Swivel Compression fittings on faucet side & 5/8" OD Compression fittings which are removable to convert to 1/2" NPS Male fittings on water supply side
- 22"L water lines
- No soldering or thread sealant tape required on faucet side



Model  
21-444L

#### EASY INSTALLATION

#### Straight Copper Water Line Installation Guide for Licensed Plumber

Install wall mount faucet on sink. Insert black washer inside brass fitting located at the end of long copper tube and attach to the cold side male water line fitting coming out of faucet and tighten properly. Connect copper tube to water source using compression fitting. Repeat procedure for hot side. After installation, turn water on and check for leaks.

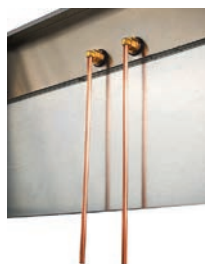

#### Flexible Stainless Steel Water Line Installation Guide for Licensed Plumber

Install wall mount faucet on sink. Insert black washer inside brass fitting located at the end of each stainless steel hose and attach to the cold side male nipple coming out of faucet and tighten properly. Repeat procedure for hot side. Connect to water source using compression fitting or male NPS fitting and tighten properly. After installation, turn water on and check for leaks.



# Flexible Water Line & Faucet Mounting Kits



## Flexible Water Line Kit with Heavy Duty Wall Mounting Kit

- Includes (2) 3/8" Stainless Steel Braided Flexible Supply Hoses
- 1/2" Female NPT Fittings on faucet side, 3/8" Compression Fittings on supply side
- Includes (2) 1/2" NPT Male x 1/2" NPS Female Close Elbows, (2) 1/2" NPS x 1-1/2" Brass Nipples, (2) Lock Nuts, (2) Rosettes, (2) Rubber Gaskets
- 24"L water lines
- No soldering or thread sealant tape required

Model  
**21-193L**



## Heavy Duty Wall Mounting Kit

- For wall mount faucets & pre-rinse units
- Space Saving Design
- Includes (2) 1/2" NPT Male x 1/2" NPS Female Close Elbows, (2) 1/2" NPS x 1-1/2" Brass Nipples, (2) Lock Nuts, (2) Rosettes, (2) Rubber Gaskets

Model  
**21-192L**



## 1/2" x 3/8" Braided Supply Hoses

- Includes (2) 3/8" Stainless Steel Braided Flexible Supply Hoses
- 1/2" Female NPT Fittings on faucet side, 3/8" Compression Fittings on supply side
- 24"L water lines
- No soldering or thread sealant tape required

Model  
**21-198L**



## Standard Wall Mounting Kit

- For wall mount faucets & pre-rinse units
- Includes (2) 1/2" NPT Male x 1/2" NPS Female brass elbows, (2) 1/2" NPS x 1-1/2" Brass Nipples, (2) Lock Nuts, (2) Rosettes, (2) Rubber Gaskets

Model  
**21-190L**



## Space Saver 90° Elbow Kit

- Space Saving Design
- Solid Brass
- Includes (2) 1/2" NPT female close elbows

Model  
**21-191L**



## Mounting Kit

- For wall mount faucets & pre-rinse units
- Includes: (2) 1/2" NPS x 1-1/2" Brass Nipples, (2) Lock Nuts, (2) Rosettes, (2) Rubber Gaskets

Model  
**21-194L**



## Deck Mounting Kit

- Includes: (2) 1/2" NPS x 3-1/2" Brass Nipples, (2) Lock Nuts, (2) Rosettes, (2) Rubber Gaskets

Model  
**21-196L**

**New**



## Faucet Shank Extension Kit

- For thicker deck installations where extra shank length is needed
- Includes (2) 1/2" NPS x 2" shank extensions, (4) washers, (2) spacers

Model  
**21-199L**

**New**



## Thread Sealant Tape

- 1/2" x 260" roll
- 100% pure PTFE
- 0.42 g/cm<sup>3</sup> density
- ULc and CSA listed

Model  
**25-150**

# Replacement Valves & Handles

## Most Popular

### 1/4 Turn High Performance Ceramic Cartridge Valves

- Fits all Royal Series faucets & pre-rinse units
- Integral check valve
- Fully assembled, easy to install

Model	Description
21-308L	Cold Valve
21-309L	Hot Valve



## New

### 1/4 Turn High Performance Ceramic Cartridge Valves Less Handles

- Handles not included

Model	Description
21-333L	Cold Valve
21-334L	Hot Valve



### 1/4 Turn Compression Cartridge Valves

- Fits all Royal Series faucets
- Integral check valve
- Fully assembled, easy to install



Model	Description
21-330L	Cold Valve
21-331L	Hot Valve



### Cross Handle 1/4 Turn Ceramic Cartridge Valves (Full Flow Faucet Only)

- Fits 3/4" full flow faucet only (18-8 Series)
- Fully assembled, easy to install



Model	Description
21-350L	Cold Valve
21-351L	Hot Valve



### Lever Handle Kit

- Fits all Krowne faucets
- Contains (2) screws, (2) handles, hot & cold indicator
- Solid chrome plated brass

Model
21-306



### Wrist Blade Handle Kit

- Fits all Krowne faucets
- 4" length
- Contains (2) screws, (2) handles, hot & cold indicator
- Solid chrome plated brass

Model
21-311

## New



### Vandal Resistant Wrist Blade Handle Kit

- Fits all Krowne faucets
- 4" length
- Contains (2) screws, (2) handles, hot & cold indicator
- Solid chrome plated brass

Model
21-313



# Spouts

## Universal Swing Spouts

- Built for high volume
- Double O-ring construction
- Fits all Krowne faucets & interchangeable with most brands; includes adapter to fit T&S Brass\* faucets



Model	Spout Size	Flow Rate
<b>21-420L</b>	6" Swing Spout	1.8 GPM
<b>21-421L</b>	8" Swing Spout	1.8 GPM
<b>21-422L</b>	10" Swing Spout	1.8 GPM
<b>21-423L</b>	12" Swing Spout	1.8 GPM
<b>21-424L</b>	14" Swing Spout	1.8 GPM
<b>21-425L</b>	16" Swing Spout	1.8 GPM
<b>21-426L</b>	18" Jointed Spout	1.8 GPM

## Gooseneck Spouts & Double Bend Swing Spouts

- Double O-ring construction
- Fits all Krowne faucets
- Interchangeable with most brands; includes adapter to fit T&S Brass\* faucets



Model	Spout Size	Height	Flow Rate
<b>21-427L</b>	3-1/2" Wide Gooseneck Spout	7-1/4"	0.5 GPM
<b>21-428L</b>	6" Wide Gooseneck Spout	8-1/2"	1.8 GPM
<b>21-429L</b>	8-1/2" Wide Gooseneck Spout	10"	1.8 GPM
<b>21-430L</b>	4-1/2" Wide Double Bend Spout	6"	0.5 GPM
<b>21-431L</b>	6" Wide Double Bend Spout	8-1/2"	1.8 GPM
<b>21-432L</b>	8-1/2" Wide Double Bend Spout	11"	1.8 GPM

## Universal Swing Spouts Less Aerators

- Double O-ring construction
- Fits all Krowne faucets & interchangeable with most brands; includes adapter to fit T&S Brass\* faucets
- For aerator options, see page 45



Model	Spout Size
<b>21-420L-X</b>	6" Swing Spout
<b>21-421L-X</b>	8" Swing Spout
<b>21-422L-X</b>	10" Swing Spout
<b>21-423L-X</b>	12" Swing Spout
<b>21-424L-X</b>	14" Swing Spout
<b>21-425L-X</b>	16" Swing Spout
<b>21-427L-X</b>	3-1/2" Wide Gooseneck Spout
<b>21-428L-X</b>	6" Wide Gooseneck Spout
<b>21-429L-X</b>	8-1/2" Wide Gooseneck Spout
<b>21-430L-X</b>	4-1/2" Wide Double Bend Spout
<b>21-431L-X</b>	6" Wide Double Bend Spout
<b>21-432L-X</b>	8-1/2" Wide Double Bend Spout

**New**

## 3/4" Full Flow Replacement Spouts

- Used on 18-8XXL Faucets



Model	Spout Size
<b>21-458L</b>	6-1/2" Swing Full Flow Spout
<b>21-460L</b>	12" Swing Full Flow Spout
<b>21-461L</b>	14" Swing Full Flow Spout
<b>21-463L</b>	18" Swing Full Flow Spout
<b>21-465L</b>	18" Jointed Full Flow Spout
<b>21-467L</b>	24" Jointed Full Flow Spout

**New**

## Spout Extensions

- Adds flexibility to accommodate most swivel spout lengths
- Cannot be used on 3/4" Full Flow Spout



Model	Spout Size
<b>21-405L</b>	6" Extension
<b>21-404L</b>	12" Extension
<b>21-469L</b>	12" Full Flow Extension

## Replacement Spout with Shut-Off Valve

- Used on Pot Filler Faucets

Model	Spout Size
<b>21-442L</b>	6" Swing
<b>21-441L</b>	12" Swing



**New**

## Rigid Gooseneck Spouts

- 3/8" Male Threading

Model	Spout Size	GPM
<b>21-227L</b>	3-3/4"W Spout	0.5
<b>21-228L</b>	5-3/4"W Spout	0.5
<b>21-229L</b>	8"W Spout	0.5



\*This product is not manufactured or authorized by any other manufacturer. Registered Trade Name or Mark of the original manufacturer of the product which this part fits, is not owned, associated or to be confused with our company.

## Coupling Flanges



### Coupling Flanges

- Fits all Royal Series faucets
- Eccentric fittings
- 1/2" NPT female inlet
- 1/4" adjustment per flange
- Two rubber washers

Model  
21-401L



### Coupling Flanges with Built-in Shut-off Valves

- Fits all Royal Series faucets
- Built-in shut-off valve
- Eccentric fittings
- 1/2" NPT female inlet
- Two rubber washers



Model  
21-452L



### Medium Adjustable Supply Inlets

- Fits Krowne Royal Series
- Adjustable centers
- 1" total range
- 1/2" NPT female inlet
- Two rubber washers

Model  
21-402L



### Large Adjustable Supply Inlets

- Fits Krowne Royal Series
- Adjustable centers
- 2" total range
- 1/2" NPT female inlet
- Two rubber washers

Model  
21-403L



### Replacement Washer Set

- 12 pieces per set
- Fits all Royal Series coupling flanges

Model  
21-407

## Coupling Flange Adapters



### The Ultimate E-Z Install Faucet Adapter

- Allows you to mount all Royal Series faucets on existing Fisher\*, Chicago\*, Central Brass\*, and 12-8XXL Krowne supply inlets
- Not required for T&S\* brass
- Eliminates the need to change supply inlets on sink
- Substantially cuts installation time

Model  
**21-534L**

### Quick Connect for Fisher\*

- Adapter to easily attach to existing Fisher\* Couplings
- Quick & Easy installation



Model  
**21-500L**

### Replacement Valves for Fisher\*

- Fits most Fisher\* models
- Includes check valve



Model	Spout Size
<b>21-320L</b>	Cold Stem Assembly
<b>21-321L</b>	Hot Stem Assembly

### Quick Connect for Chicago\*

- Allows Krowne 14-8XXL Series to mount on existing Chicago\* Faucet fittings
- Quick & Easy installation



Model  
**21-532L**

### Quick Connect for All Krowne Silver Series

- Allows you to mount Royal Series Faucets on 12-8XXL Commercial Series supply inlets
- Quick & Easy installation



Model  
**21-528L**

### Quick Connect for Central Brass\*

- Adapter to easily attach Royal Series faucets to existing Central Brass\* Couplings
- Quick & Easy installation



Model  
**21-527L**

### Quick Connect for Central Brass\*

- Adapter to easily attach 12-8 series faucets to existing Central Brass\* Couplings
- Quick & Easy installation



Model  
**21-525L**

\*This product is not manufactured or authorized by any other manufacturer. Registered Trade Name or Mark of the original manufacturer of the product which this part fits, is not owned, associated or to be confused with our company.

# Adapters & Vacuum Breakers



## Chemical Swivel Tee Assembly

- Fits most manufacturers
- Installs on spout opening
- 3/8" NPT Female Tee Fitting on side
- Spout Fitting on Top
- Chrome Plated Brass
- Adapter to fit T&S Brass\* included

Model  
**21-546L**



## Chemical Rigid Tee Assembly

- Fits most manufacturers
- Installs on Pre-Rinse bases
- 3/8" NPT Close Nipple
- 3/8" NPT Female Thread
- 3/8" NPT Tee Fitting on side
- Chrome Plated Brass

Model  
**21-545L**

## Vacuum Breaker Assembly

- 6" centers
- Installs in backsplash
- 1/2" NPT male threads
- Adjustable flanges
- Polished chrome plated brass body

Model  
**21-455L**



## Vacuum Breaker

- Converts Royal Series faucet to Utility Spray or Pot Filler
- Fits onto standard size spout opening
- Hose attaches to outlet
- High water flow with minimal pressure loss
- Temperature 40°F -140°F
- Pressure 20-125 PSI

Model  
**21-450L**



## In-Line Vacuum Breaker

- Prevents back flow
- For hose thread faucets where Pre-Rinse or spray hoses are attached
- Prevents back flow of contaminated water into safe drinking water supply
- 3/8" NPS male inlet
- 3/8" NPS female outlet

Model  
**21-109L**



## Spout on Pre-Rinse Body Adapter

- Rigid to Swing adapter
- Allows conversion of faucets with 3/8" NPT female outlets to accept swing spouts or swivel gooseneck spouts

Model  
**21-110L**



## Pre-Rinse Hose to 1/2" NPT Male Adapter

- Converts Pre-rinse hose to 1/2" Male fitting

Model  
**21-114L**



## Top of Riser (Rigid) to Swing Adapter

- Allows riser pipe to accommodate swing spout or swivel gooseneck spout
- 3/8" NPT female inlet

Model  
**21-115L**



## Swing to Riser Pipe Adapter for Pre-Rinse

- Allows conversion of faucets with swivel spouts to accept 3/8" NPT male riser pipes or rigid gooseneck spouts
- Wrench included

Model  
**21-118L**

## Spout Adapters

Model	Spout Size	
21-117L	Spout Adapter for Chicago* Allows Krowne Spout to fit on Chicago* 00-47 Series Faucets	
21-125L	Spout Adapter for Fisher* Allows Krowne Spout to fit on Fisher* Faucets	
21-524L	Spout Adapter for Central Brass* Allows Krowne Spout to fit on Central Brass* 00-47 Series Faucets	

## Pre-Rinse Hose to Top of Riser Adapter

Model	Spout Size	
21-112L	Adapter for Fisher* Converts Pre-Rinse Hose to 1/4" Male fitting	
21-113L	Adapter for Chicago* Converts Pre-Rinse Hose to 3/8" Male fitting	

# Aerators/Outlets

- 55/64-27 Female Thread Outlets
- 15/16 Male Thread Outlets



Aerated Stream



Female



Male

## Aerators

### Female

Model	Flow Rate
<b>22-600L</b>	0.50 GPM Female Thread
<b>22-608L</b>	1.00 GPM Female Thread
<b>22-609L</b>	1.20 GPM Female Thread
<b>22-610L</b>	1.50 GPM Female Thread
<b>22-626L</b>	1.75 GPM Female Thread
<b>22-611L</b>	2.20 GPM Female Thread

### Male

Model	Flow Rate
<b>22-620L</b>	0.50 GPM Male Thread
<b>22-621L</b>	1.00 GPM Male Thread
<b>22-622L</b>	1.20 GPM Male Thread
<b>22-625L</b>	1.50 GPM Male Thread
<b>22-628L</b>	2.20 GPM Male Thread



Aerated Stream



Female



Male



Includes Install Key

## Aerators (Vandal Resistant)

### Female

Model	Flow Rate
<b>22-584L</b>	0.50 GPM Female Thread
<b>22-586L</b>	1.00 GPM Female Thread
<b>22-640L</b>	1.20 GPM Female Thread
<b>22-588L</b>	1.50 GPM Female Thread
<b>22-634L</b>	2.20 GPM Female Thread

### Male

Model	Flow Rate
<b>22-585L</b>	0.50 GPM Male Thread
<b>22-587L</b>	1.00 GPM Male Thread
<b>22-650L</b>	1.20 GPM Male Thread
<b>22-589L</b>	1.50 GPM Male Thread
<b>22-633L</b>	2.20 GPM Male Thread



Laminar Stream



Female



Male

## Laminar Flow Outlets

### Female

Model	Flow Rate
<b>22-592L</b>	0.50 GPM Female Thread
<b>22-594L</b>	1.50 GPM Female Thread

### Male

Model	Flow Rate
<b>22-591L</b>	0.50 GPM Male Thread
<b>22-593L</b>	1.50 GPM Male Thread



Laminar Stream



Female



Male



Includes Install Key

## Laminar Flow Outlets (Vandal Resistant)

### Female

Model	Flow Rate
<b>22-598L</b>	0.50 GPM Female Thread
<b>22-602L</b>	1.00 GPM Female Thread
<b>22-604L</b>	1.50 GPM Female Thread

### Male

Model	Flow Rate
<b>22-599L</b>	0.50 GPM Male Thread
<b>22-603L</b>	1.00 GPM Male Thread
<b>22-605L</b>	1.50 GPM Male Thread



Spray Stream



Female



Male

## Multi-Laminar Spray Outlets

### Female

Model	Flow Rate
<b>22-572L</b>	0.35 GPM Female Thread
<b>22-574L</b>	0.50 GPM Female Thread
<b>22-576L</b>	1.00 GPM Female Thread

### Male

Model	Flow Rate
<b>22-573L</b>	0.35 GPM Male Thread
<b>22-575L</b>	0.50 GPM Male Thread
<b>22-577L</b>	1.00 GPM Male Thread



Spray Stream



Female



Male



Includes Install Key

## Multi-Laminar Spray Outlets (Vandal Resistant)

### Female

Model	Flow Rate
<b>22-578L</b>	0.35 GPM Female Thread
<b>22-580L</b>	0.50 GPM Female Thread

### Male

Model	Flow Rate
<b>22-579L</b>	0.35 GPM Male Thread
<b>22-581L</b>	0.50 GPM Male Thread

## Garden Hose Adapters



Female



Male

### Female Garden Hose Adapter

Model	Description
<b>22-632L</b>	Female Garden Hose Adapter

### Male Garden Hose Adapter

Model	Description
<b>22-631L</b>	Male Garden Hose Adapter



# Lavatory Faucets

**Krowne** offers an extensive selection of **Lavatory Faucets** for multiple environments including restrooms, schools, hotels, medical offices, bars, restaurants and more. Our water saving aerators and adjustable metering valves are useful in high volume applications to limit the consumption of water.

**New**

## Single Hole Single Lever Lavatory Faucet

- Ceramic cartridge valve with built-in temperature limit stop
- Single hole 3/8" NPS male inlet
- 1.5 GPM aerator installed
- Single lever handle
- Color coded index
- Solid chrome plated brass
- ADA Compliant



### Faucet

Model	Description
<b>14-510L</b>	Single Hole Single Lever Lavatory Faucet

### Replacement Parts

Model	Description
<b>21-345L</b>	Single Lever Ceramic Valve Repair Kit
<b>21-346L</b>	Single Lever Handle
<b>21-198L</b>	1/2" x 3/8" Braided Supply Hoses

For aerator options see page 45





**Faucet**

Model	Description
14-550L	Single Hole Single Lever Lavatory Faucet

**New**

**Single Hole Single Handle Lavatory Faucet**

- Ceramic cartridge valve with metal stem
- Pre-installed 3/8" compression water lines
- 1.2 GPM aerator installed
- Single lever handle
- Chrome plated stainless steel
- ADA Compliant

**Replacement Parts**

Model	Description
21-344L	Replacement Single Lever Valve
21-195L	13" Replacement Water Line Kit

For aerator options see page 45



**Faucet**

Model	Description
14-570L	4" Deck Mount Lavatory Faucet with Cast Spout

**New**

**4" Deck Mount Lavatory Faucet with Cast Spout**

- 1/4 Turn high performance ceramic cartridge valves with integral check
- 1/2" NPS male inlets on 4" centers
- 1.5 GPM aerator installed
- Lever handles
- Color coded index
- Solid chrome plated brass
- ADA compliant

**Replacement Parts**

Model	Description
21-308L	Cold 1/4 Turn Ceramic Cartridge Valve
21-309L	Hot 1/4 Turn Ceramic Cartridge Valve
21-198L	1/2" x 3/8" Braided Supply Hoses

For aerator options see page 45



**Faucet**

Model	Description
14-580L	4" Deck Mount Lavatory Faucet with Wrist Blade Handles

**New**

**4" Deck Mount Lavatory Faucet with Cast Spout and Wrist Blade Handles**

- 1/4 Turn high performance ceramic cartridge valves with integral check
- 1/2" NPS male inlets on 4" centers
- 1.5 GPM aerator installed
- Vandal resistant wrist blade handles
- Color coded index
- Solid chrome plated brass
- ADA compliant

**Replacement Parts**

Model	Description
21-333L	Cold 1/4 Turn Ceramic Cartridge Valve Less Handle
21-334L	Hot 1/4 Turn Ceramic Cartridge Valve Less Handle
21-198L	1/2" x 3/8" Braided Supply Hoses
21-313	Vandal Resistant Wrist Blade Handle Kit

For aerator options see page 45





**Faucet**

Model	Description
<b>14-530L</b>	4" Deck Mount Metering Lavatory Faucet

**New Style**

**4" Center Deck Mount Metering Lavatory Faucet**

- Self-closing metering valves with adjustable timed flow (3-20 seconds)
- 1/2" NPS male inlets on 4" centers
- 2.2 GPM vandal resistant aerator installed
- Vandal resistant push button cap
- Solid chrome plated brass
- ADA Compliant

**Replacement Parts**

Model	Description
<b>21-363L</b>	Metering Valve Repair Kit (Hot or Cold)
<b>21-198L</b>	1/2" x 3/8" Braided Supply Hoses

For aerator options see page 45



**Faucet**

Model	Description
<b>14-560L</b>	Single Hole Metering Lavatory Faucet

**New Style**

**Single Hole Deck Mount Metering Lavatory Faucet**

- Single hole, single temperature
- Self-closing metering valves with adjustable timed flow (3-20 seconds)
- 1/2" NPS male inlet
- 2.2 GPM vandal resistant aerator installed
- Vandal resistant push button cap
- Solid chrome plated brass
- ADA Compliant

**Replacement Parts**

Model	Description
<b>21-363L</b>	Metering Valve Repair Kit (Hot or Cold)

For aerator options see page 45



**Faucet**

Model	Description
<b>16-450L</b>	Single Hole Faucet with 5-5/8"W Rigid Gooseneck

**Single Hole Faucet with 5-5/8"W Rigid Gooseneck Spout**

- 1/4 Turn high performance ceramic cartridge valves w/ integral check
- 1-1/8" OD x 2-1/4" shank; fits 1-1/4" hole
- 20" water lines w/ 3/8" compression fittings
- 1.2 GPM aerator installed, 2.2 GPM aerator included
- Lever handles
- Color coded index
- Solid chrome plated brass
- ADA Compliant

**Replacement Parts**

Model	Description
<b>21-308L</b>	Cold 1/4 Turn Ceramic Cartridge Valve
<b>21-309L</b>	Hot 1/4 Turn Ceramic Cartridge Valve
<b>21-195L</b>	13" Replacement Water Line Kit
<b>21-311</b>	Wrist Blade Handle Kit

For aerator options see page 45







### 4" Center Deck Mount Lavatory Faucet with Cast Spout

- Ceramic cartridge valve with built-in temperature limit stop
- 1/2" NPS male inlets on 4" centers
- 0.5 GPM aerator installed, 1.5 GPM aerator included
- Single lever handle
- Model 14-521L includes Pop-Up Drain
- Color coded index
- Solid chrome plated brass
- ADA Compliant

#### Replacement Parts

Model	Description
<b>21-345L</b>	Single Lever Ceramic Valve Repair Kit
<b>21-346L</b>	Single Lever Handle Repair Kit
<b>21-198L</b>	1/2" x 3/8" Braided Supply Hoses

For aerator options see page 45

#### Faucets

Model	Description
<b>14-520L</b>	4" Deck Mount Lavatory Faucet with Cast Spout
<b>14-521L</b>	4" Deck Mount Lavatory Faucet with Cast Spout Includes Plastic Pop-Up Drain



ADA Compliant



### 4" Center Deck Mount Lavatory Faucet with 3-3/4" Wide Rigid Gooseneck Spout

- ¼ Turn high performance ceramic cartridge valves with integral check
- ½" NPS male inlets on 4" centers
- 0.5 GPM aerator installed, 1.5 GPM aerator included
- Wrist blade handles
- Color coded index
- Solid chrome plated brass
- ADA Compliant

#### Faucet

Model	Description
14-546L	4" Deck Mount Lavatory Faucet with 3-3/4"W Rigid Gooseneck

#### Replacement Parts

Model	Description
21-333L	Cold 1/4 Turn Ceramic Cartridge Valve Less Handle
21-334L	Hot 1/4 Turn Ceramic Cartridge Valve Less Handle
21-198L	1/2" x 3/8" Braided Supply Hoses
21-311	Wrist Blade Handle Kit

For aerator options see page 45



ADA Compliant



**Faucet**

Model	Description
<b>14-840L</b>	8" Deck Mount Lavatory Faucet with 5-3/4"W Rigid Gooseneck Spout

### 8" Deck Mount Lavatory Faucet with 5-3/4" Wide Rigid Gooseneck Spout

- ¼ Turn high performance ceramic cartridge valves with integral check
- ½" NPS male inlets on 8" centers
- 1.2 GPM aerator installed, 2.2 GPM aerator included
- Wrist blade handles
- Color coded index
- Solid chrome plated brass
- ADA Compliant

**Replacement Parts**

Model	Description
<b>21-333L</b>	Cold 1/4 Turn Ceramic Cartridge Valve Less Handle
<b>21-334L</b>	Hot 1/4 Turn Ceramic Cartridge Valve Less Handle
<b>21-198L</b>	1/2" x 3/8" Braided Supply Hoses
<b>21-311</b>	Wrist Blade Handle Kit

For aerator options see page 45



**Faucet**

Model	Description
<b>14-841L</b>	8" Deck Mount Lavatory Faucet with 8"W Rigid Gooseneck Spout

### 8" Deck Mount Lavatory Faucet with 8" Wide Rigid Gooseneck Spout

- ¼ Turn high performance ceramic cartridge valves with integral check
- ½" NPS male inlets on 8" centers
- 1.2 GPM aerator installed, 2.2 GPM aerator included
- Wrist blade handles
- Color coded index
- Solid chrome plated brass
- ADA Compliant

**Replacement Parts**

Model	Description
<b>21-333L</b>	Cold 1/4 Turn Ceramic Cartridge Valve Less Handle
<b>21-334L</b>	Hot 1/4 Turn Ceramic Cartridge Valve Less Handle
<b>21-198L</b>	1/2" x 3/8" Braided Supply Hoses
<b>21-311</b>	Wrist Blade Handle Kit

For aerator options see page 45



### Single Hole Wall Mount Self-Closing Faucet

- Single hole, single temp
- Self-closing twist valve
- ½" NPS male inlet
- 1.8 GPM aerator installed
- Cross handle with color coded index
- Solid chrome plated brass

Model	Description
<b>16-470L</b>	Single Hole Wall Mount Self-Closing Faucet

# Electronic Sensor Faucets

**Krowne Electronic Sensor Faucets** are designed to conserve water, reduce the spread of illness and infection, and prevent cross contamination. Each faucet is uniquely designed for easy installation and maintenance in all applications and they come with an industry leading 3-year warranty.



## Diamond Series Electronic Sensor Faucets

DIAMOND<sup>™</sup>  
series



ADA Compliant

### 4" Center Wall Mount with Satin Finish

- Infrared Sensor Operated
- Battery Powered Control Module, (4) AA Batteries Included, AC Adapter Optional
- Low Battery Indicator Light
- Easy Adjust Shut-Off Delay, Auto Flush, Auto Time-Out and Range Sensitivity
- 2.2 GPM Aerator Installed
- Includes Control Module, Mechanical Mixing Valve & (3) Supply Hoses
- Replacement Spouts available

Model  
**16-670**

#### Replacement Spouts

Model	Description
<b>21-433L</b>	4-1/2" Satin Finish Double Bend
<b>21-434L</b>	6-1/2" Satin Finish Double Bend

#### Replacement Aerators

Model	Description
<b>22-671L</b>	1.0 GPM Honeycomb Aerator
<b>22-672L</b>	2.2 GPM Honeycomb Aerator

DIAMOND<sup>™</sup>  
series



ADA Compliant

### Single Hole Wall Mount with Satin Finish

- Infrared Sensor Operated
- Battery Powered Control Module, (4) AA Batteries Included, AC Adapter Optional
- Low Battery Indicator Light
- Easy Adjust Shut-Off Delay, Auto Flush, Auto Time-Out and Range Sensitivity
- 1.0 GPM Aerator Installed
- Includes Control Module, Mechanical Mixing Valve & (3) Supply Hoses

Model  
**16-675**



ADA Compliant



### Single Hole Wall Mount

- Infrared Sensor Operated
- Battery Powered Control Module, (4) AA Batteries Included, AC Adapter Optional
- Low Battery Indicator Light
- 2.2 GPM Aerator Installed
- Includes Control Module, Mechanical Mixing Valve & (3) Supply Hoses
- Solid Chrome Plated Brass

Model	Description
<b>16-190</b>	4-1/2" Wide Gooseneck Spout
<b>16-191</b>	6" Wide Gooseneck Spout



ADA Compliant



### 4" Center Deck Mount with Cast Spout

- Infrared Sensor Operated
- Battery Powered Control Module, (4) AA Batteries Included, AC Adapter Optional
- Low Battery Indicator Light
- 2.2 GPM Aerator Installed
- Includes Control Module, Mechanical Mixing Valve & (3) Supply Hoses
- Solid Chrome Plated Brass

Model  
**16-197**



### Single Hole Deck Mount

- Infrared Sensor Operated
- Battery Powered Control Module, (4) AA Batteries Included, AC Adapter Optional
- Low Battery Indicator Light
- 2.2 GPM Aerator Installed
- Includes Control Module, Mechanical Mixing Valve & (3) Supply Hoses
- Solid Chrome Plated Brass

**Model**  
**16-654**



### Single Hole Deck Mount with Deck Plate

- Infrared Sensor Operated
- Battery Powered Control Module, (4) AA Batteries Included, AC Adapter Optional
- Low Battery Indicator Light
- 2.2 GPM Aerator Installed
- Includes Control Module, Mechanical Mixing Valve & (3) Supply Hoses
- Solid Chrome Plated Brass

Model	Description
<b>16-654P</b>	Includes 4" Deck Plate
<b>16-654P8</b>	Includes 8" Deck Plate



### Single Hole Deck Mount with Cast Spout

- Infrared Sensor Operated
- Battery Powered Control Module, (4) AA Batteries Included, AC Adapter Optional
- Low Battery Indicator Light
- 2.2 GPM Aerator Installed
- Includes Control Module, Mechanical Mixing Valve & (3) Supply Hoses
- Solid Chrome Plated Brass

**Model**  
**16-196**



### Single Hole Deck Mount with Cast Spout & Deck Plate

- Infrared Sensor Operated
- Battery Powered Control Module, (4) AA Batteries Included, AC Adapter Optional
- Low Battery Indicator Light
- 2.2 GPM Aerator Installed
- Includes Control Module, Mechanical Mixing Valve & (3) Supply Hoses
- Solid Chrome Plated Brass

Model	Description
<b>16-196P</b>	Includes 4" Deck Plate
<b>16-196P8</b>	Includes 8" Deck Plate

## Built-in Control Module Faucets

New



### Single Hole Deck Mount Angled Faucet

- Infrared sensor operated
- Includes faucet, mechanical mixing valve, (3) supply hoses, 1/2" x 1/2" debris filter and (4) AA batteries (not included)
- Built-in battery powered control module
- Low battery indicator light
- 30 seconds auto shut-off
- 2.2 GPM aerator installed
- Solid chrome plated brass

Model  
**16-656**



New



### Single Hole Wall Mount Straight Faucet

- Infrared sensor operated
- Includes faucet, mechanical mixing valve, (3) supply hoses, 1/2" x 1/2" debris filter and (4) AA batteries (not included)
- Built-in battery powered control module
- Low battery indicator light
- 30 seconds auto shut-off
- 2.2 GPM aerator installed
- Solid chrome plated brass

Model  
**16-655**



**16-649**

**16-649P**

### Single Hole Deck Mount with 4-1/2" Rigid Gooseneck Spout

- Infrared sensor operated
- Battery powered control module, (4) AA batteries included, AC adapter optional
- Low battery indicator light
- 4-1/2"W rigid gooseneck spout
- 2.2 GPM aerator installed
- Includes control module, mechanical mixing valve & (3) supply hoses
- Solid chrome plated brass

Model	Description
<b>16-649</b>	Faucet

Model	Description
<b>16-649P</b>	Faucet with 4" Deck Plate
<b>16-649P8</b>	Faucet with 8" Deck Plate



**16-650**

**16-650P**

### Single Hole Deck Mount with 6" Rigid Gooseneck Spout

- Infrared sensor operated
- Battery powered control module, (4) AA batteries included, AC adapter optional
- Low battery indicator light
- 6"W rigid gooseneck spout
- 2.2 GPM aerator installed
- Includes control module, mechanical mixing valve & (3) supply hoses
- Solid chrome plated brass

Model	Description
<b>16-650</b>	Faucet

Model	Description
<b>16-650P</b>	Faucet with 4" Deck Plate
<b>16-650P8</b>	Faucet with 8" Deck Plate

# Electronic Faucet Replacement Parts & Accessories

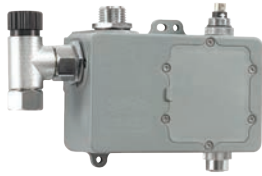

Control Module

Model  
16-198



Mechanical Mixing Valve with Built-in Check Valve

Model  
16-402L



Thermostatic Mixing Valve with Built-in Check Valves

Model  
16-405L

- 1070 ASSE approved



AC Adapter

- Eliminates the need for batteries

Model  
16-199



Water Supply Hoses for Electronic Faucets

- Feeds water from water supply to mixing valve
- 1/2" Female NPS x 3/8" compression
- 2 18" hoses included

Model  
16-510



Spout Supply Hose for **Wall Mount** Electronic Faucets

- Fits wall mount e-faucets
- Feeds water from mixing valve to faucet
- (1) 18"L water supply hose
- 3/8" Female NPS x 1/2" Female NPS

Model  
16-512



Spout Supply Hose for **Deck Mount** Electronic Faucets

- Fits deck mount e-faucets (except 16-654)
- Feeds water from mixing valve to faucet
- (1) 18"L water supply hose
- 1/4" Female NPS x 1/2" Female NPS

Model  
16-511



Spout Supply Hose for **16-654** Faucet

- Fits 16-654 faucets
- Feeds water from mixing valve to faucet
- (1) 18"L water supply hose
- 3/8" Female NPS x 1/2" Female NPT

Model  
16-517



Flat Sensor with Cable

- Fits models 16-190, 16-191, 16-197, 16-670

Model  
16-505



Convex Sensor with Cable

- Fits models 16-196, 16-649, 16-650, 16-654

Model  
16-506

Hydro Generator



- Generates power by using the water flow
- No AC power required
- Eliminates the need for batteries

Model  
16-501



# Electronic Faucet Replacement Parts & Accessories



## 4" Deck Plate

- Fits all Krowne single hole deck mount electronic faucets

Model  
16-189



New

## 8" Deck Plate

- Fits all Krowne single hole deck mount electronic faucets

Model  
16-186



## Deck Mount Soap Dispenser

- Fits in 1-1/8" Hole
- 13 oz.

Model  
H-101

New

# Electronic Faucet Daisy Chain Parts & Accessories

- Connect multiple electronic faucets to one power source using our Daisy Chain parts and accessories



## Box Mount Transformer

- Box mounted power converter to power up to 8 electronic faucets
- For use with 16-513 Daisy Chain Extension Cable
- For use with 16-514 5' Long Extension Cable

Model  
16-516



## AC Adapter for Daisy Chain

- Provides power for up to 8 electronic faucets
- For use with 16-513 Daisy Chain Extension Cable
- For use with 16-514 5' Long Extension Cable

Model  
16-199



## Daisy Chain Extension Cable

- For connecting up to 8 electronic sensor faucets to a single power supply
- For use with 16-514 5'L Extension Cable
- For use with 16-515 AC Adapter for Daisy Chain
- For use with 16-516 Box Mount Transformer

Model  
16-513



## 5 ft. Extension Cable

- 5' long wire provides additional length
- For use with 16-513 Daisy Chain Extension Cable
- For use with 16-515 and 16-199 AC Adapters
- For use with 16-516 Box Mount Transformer

Model  
16-514

# Silver Series Plumbing

**Krowne Silver Series** plumbing products are built for mid to high volume applications. We have meticulously engineered this product line to combine both quality and value resulting in a healthy balance geared for most environments.

Available in over 100 different configurations, you can rest easy knowing you are receiving a high quality plumbing product at a competitive price.



## 4" Center Wall Mount Faucet

- ¼ Turn ceramic valves
- ½" NPS male inlets on 4" centers
- 1.8 GPM aerator installed
- Durable full range swing spout with double o-ring construction
- Lever handles
- Chrome plated finish



10-406L

Model	Spout Size	Case Qty
10-406L	6" Swing	20
10-410L	10" Swing	20
10-400L	3-1/2" Wide Gooseneck (0.5 GPM)	20
10-400L-W	3-1/2" Wide Gooseneck (0.5 GPM) with Wrist Blade Handles	-

### Replacement Parts

Model	Description
21-300L	1/4 Turn Ceramic Valve Kit
21-443L	E-Z Install Flexible Water Line Kit

For aerator and spout options see pages 45 & 64

## 4" Center Wall Mount Faucet with Double Bend Spout

- ¼ Turn ceramic valves
- ½" NPS male inlets on 4" centers
- 0.50 GPM aerator installed
- Durable full range swing spout with double o-ring construction
- Lever handles
- Chrome plated finish



10-435L

Model	Spout Size	Case Qty
10-435L	4-1/2"W Double Bend Spout	20
10-435L-W	4-1/2"W Double Bend Spout with Wrist Blade Handles	-

### Replacement Parts

Model	Description
21-300L	1/4 Turn Ceramic Valve Kit
21-443L	E-Z Install Flexible Water Line Kit

For aerator and spout options see pages 45 & 64

## 8" Center Wall Mount Faucet

- ¼ Turn ceramic valves
- ½" NPT female inlets on 8" centers
- 1.8 GPM aerator installed
- Durable full range swing spout with double o-ring construction
- Lever handles
- Chrome plated finish



12-812L

12-801L

Model	Spout Size	Case Qty
12-806L	6" Swing	12
12-808L	8" Swing	12
12-810L	10" Swing	12
12-812L	12" Swing	12
12-814L	14" Swing	12
12-816L	16" Swing	12
12-818L	18" Jointed	12
12-824L	24" Jointed	12
12-801L	6" Wide Gooseneck	12
12-802L	8-1/2" Wide Gooseneck	12
12-8XXL	Faucet Body (No Spout)	12

### Replacement Parts

Model	Description
21-310L	1/4 Turn Ceramic Valve Kit
21-445L	E-Z Install Flexible Water Line Kit

For aerator and spout options see pages 45 & 64

## 4" Center Deck Mount Faucet

- ¼ Turn ceramic valves
- ½" NPS male inlets on 4" centers
- 1.8 GPM aerator installed
- Durable full range swing spout with double o-ring construction
- Lever handles
- Chrome plated finish



### Faucets

Model	Spout Size
11-406L	6" Swing Spout
11-412L	12" Swing Spout
11-400L	3-1/2" Wide Gooseneck Spout (0.5 GPM)
11-401L	6" Gooseneck Spout
11-450L	Laundry Faucet w/ Hose Adapter

### Replacement Parts

Model	Description
21-300L	1/4 Turn Ceramic Valve Kit
21-198L	1/2" x 3/8" Braided Supply Hoses

For aerator and spout options see pages 45 & 64

## 4" Center Deck Mount Faucet With Double Bend Spout

- ¼ Turn ceramic valves
- ½" NPS male inlets on 4" centers
- 1.8 GPM aerator installed
- Durable full range swing spout with double o-ring construction
- Lever handles
- Chrome plated finish



### Faucets

Model	Spout Size
11-435L	4-1/2" Wide Double Bend (0.5 GPM)
11-460L	6" Wide Double Bend

### Replacement Parts

Model	Description
21-300L	1/4 Turn Ceramic Valve Kit
21-198L	1/2" x 3/8" Braided Supply Hoses

For aerator and spout options see pages 45 & 64

## 4" Center Deck Mount Faucet with Wrist Blade Handles

- ¼ Turn ceramic valves
- ½" NPS male inlets on 4" centers
- 0.5 GPM aerator installed
- Durable full range swing spout with double o-ring construction
- Wrist blade handles
- Chrome plated finish



11-400L-W

### Faucet

Model	Spout Size
11-400L-W	3-1/2" Wide Gooseneck Spout (0.5 GPM)

### Replacement Parts

Model	Description
21-300L	1/4 Turn Ceramic Valve Kit
21-198L	1/2" x 3/8" Braided Supply Hoses
21-312	Silver Series Wrist Blade Handle Kit

For aerator options see page 45

## 4" Center Deck Mount Single Lever Faucet

- Ceramic cartridge valve
- ½" NPS Inlets w/ 3/8" OD flexible copper tubing
- 0.5 GPM aerator installed, 1.5 GPM aerator included
- Single lever handle
- Color coded index
- Chrome plated finish

Model  
12-510L



### Replacement Parts

Model	Description
21-340L	Single Lever Ceramic Valve Repair Kit
21-341	Single Lever Ceramic Valve Handle
21-198L	1/2" x 3/8" Braided Supply Hoses
12-512	Pop-Up Drain (fits 12-510L)

For aerator options see page 45

## 4" Center Deck Mount Single Lever Faucet with Pop-Up Drain

- Ceramic cartridge valve
- ½" NPS Inlets w/ 3/8" OD flexible copper tubing
- 0.5 GPM aerator installed, 1.5 GPM aerator included
- Single lever handle
- Color coded index
- Chrome plated finish

Model  
12-525L



### Replacement Parts

Model	Description
21-340L	Single Lever Ceramic Valve Repair Kit
21-341	Single Lever Ceramic Valve Handle
21-198L	1/2" x 3/8" Braided Supply Hoses

For aerator options see page 45

**New**

### Kitchen Faucet with Sprayer



- Ceramic cartridge valve with metal stem
- Pre-installed 3/8" compression water lines
- 1.8 GPM aerator installed
- Single lever handle
- Chrome plated brass

#### Faucets

Model	Description
16-350L	Kitchen Faucet with Sprayer
16-351L	Kitchen Faucet Only (No Sprayer)

#### Replacement Parts

Model	Description
16-352L	Sprayer Only
21-344L	Replacement Single Lever Valve
21-195L	13" Replacement Water Line Kit

### 8" Center Deck Mount Faucet

- 1/4 Turn ceramic valves
- 1/2" NPS male inlets on 8" centers
- 1.8 GPM aerator installed
- Durable full range swing spout with double o-ring construction
- Lever handles
- Chrome plated finish



#### Faucets

Model	Spout Size
13-806L	6" Swing Spout
13-808L	8" Swing Spout
13-810L	10" Swing Spout
13-812L	12" Swing Spout
13-814L	14" Swing Spout
13-816L	16" Swing Spout
13-818L	18" Jointed Spout
13-824L	24" Jointed Spout
13-801L	6" Wide Gooseneck Spout
13-802L	8-1/2" Wide Gooseneck Spout
13-8XXL	No Spout - Body Only

#### Replacement Parts

Model	Description
21-300L	1/4 Turn Ceramic Valve Kit
21-198L	1/2" x 3/8" Braided Supply Hoses

For aerator and spout options see pages 45 & 64

### Single Hole Deck Mount Pantry Faucet

- Single hole, single temp
- 1/4 Turn ceramic valves
- 1/2" NPS male inlet
- 1.8 GPM aerator installed
- Durable full range swing spout with double o-ring construction
- Lever handle
- Chrome plated finish



#### Faucets

Model	Spout Size
16-108L	6" Swing Spout
16-109L	12" Swing Spout
16-115L	3-1/2" Wide Gooseneck Spout (0.5 GPM)
16-116L	6" Wide Gooseneck Spout

#### Replacement Parts

Model	Description
21-300L	1/4 Turn Ceramic Valve Kit

For aerator and spout options see pages 45 & 64



16-281

## Service Sink Faucet with Cast Spout

- Flanges with eccentric fittings for quick installations
- Includes wall bracket for spout support
- ¼ Turn ceramic valves
- ½" NPT male inlets on 8" centers
- 6-1/2" heavy cast spout with pail hook and hose thread
- Mounting kit included
- Solid rough chrome brass base

### Faucet

Model	Spout Size	Case Qty.
16-281	Service Sink Faucet with Lever Handles	12



Pail Hook &amp; Hose Threads



Vacuum Breaker



Integral Stops

### Replacement Parts

Model	Description
21-308L	Cold 1/4 Turn Ceramic Cartridge Valve
21-309L	Hot 1/4 Turn Ceramic Cartridge Valve
16-282	Replacement Wall Bracket for 16-281
16-283	Vacuum Breaker Repair Kit
21-311	Wrist Blade Handle Kit
21-443L	E-Z Install Flexible Water Line Kit



MS-2424

## Floor Mop Sink

- MS-2424 Bowl Size: 21" x 21" x 9"
- MS-1818 Bowl Size: 15" x 15" x 9"
- 3-1/2" drain w/ 2" IPS outlet
- 18 gauge stainless steel
- Mounting hardware included

Model	Overall Size
MS-2424	24" x 24" x 13"
MS-1818	18" x 18" x 13"

### Replacement Parts

Model	Description
23-145	Replacement Drain

## Mop Hangers

- Stainless steel construction with spring action grips
- MH-24 size: 23"L x 4-1/2"H
- MH-5 size: 5"L x 4-1/2"H
- MH-5 includes 30" rubber hose with 3/4" garden hose inlet



MH-24



MH-5

Model	Description
MH-24	Mop Hanger with 3 Grips
MH-5	Mop Hanger with 1 Grip (Includes hose)



11-450L

## 4" Center Deck Mount Laundry Tub Faucet

- ¼ Turn ceramic cartridge valves
- ½" NPS male inlets on 4" centers
- 1.8 GPM aerator installed
- Durable full range swing spout with double o-ring construction
- Lever handles
- Chrome plated finish

Model	Spout Size
11-406L	6" Swing Spout
11-450L	6" Swing Spout with Garden Hose Adapter

# Replacement Parts for Silver Series Plumbing



## Silver Series 1/4 Turn Ceramic Valve Repair Kit (10-4, 11-4, 13-8 Series)

- Fits all 10-4, 11-4, and 13-8 series faucets
- Includes (1) hot and (1) cold ceramic valve set with handles
- Fully assembled, easy to install

Model  
**21-300L**



## Silver Series Compression Valve Repair Kit (Old Style 10-4, 11-4, 13-8 Series)

- Fits old style 10-4, 11-4, and 13-8 series faucets
- Includes (1) hot and (1) cold compression valve set with handles
- Fully assembled, easy to install

Model  
**21-325L**



## Silver Series 1/4 Turn Ceramic Valve Repair Kit (12-8 Series)

- Fits all 12-8 series faucets
- Includes (1) hot and (1) cold ceramic valve set with handles
- Fully assembled, easy to install

Model  
**21-310L**



## Silver Series Compression Valve Repair Kit (Old Style 12-8 Series)

- Fits old style 12-8 series
- Includes (1) hot and (1) cold compression valve set with handles
- Fully assembled, easy to install

Model  
**21-355L**



## Silver Series Lever Handle Kit

- Fits all Krowne faucets
- Lever style
- Contains (2) screws, (2) handles, and hot & cold indicator
- Solid chrome plated brass

Model  
**21-305**



## Silver Series Wrist Blade Handle Kit

- Fits all Silver Series faucets
- 4" length
- Contains (2) screws, (2) handles, and hot & cold indicator
- Solid chrome plated brass

Model  
**21-312**



## Silver Series Coupling Flanges

- Fits 12-8 Silver Series 8" center wall mount faucet
- 1/2" NPT female inlet
- Two rubber washers

Model  
**21-400L**



## Replacement Washer Set

- 12 pcs. per set
- Fits Silver Series coupling flanges

Model  
**20-302**

## Swing Spouts

- Fits Krowne Silver Series Faucets



Model	Spout Size	Flow Rate
19-220L	6" Swing Spout	1.8 GPM
19-221L	8" Swing Spout	1.8 GPM
19-222L	10" Swing Spout	1.8 GPM
19-223L	12" Swing Spout	1.8 GPM
19-224L	14" Swing Spout	1.8 GPM
19-225L	16" Swing Spout	1.8 GPM

## Gooseneck & Jointed Spouts

- Fits Krowne Silver Series Faucets



Model	Spout Size	Height	Flow Rate
19-226L	18" Jointed Spout	-	1.8 GPM
19-227L	3-1/2"W Gooseneck	7-1/4"	0.5 GPM
19-228L	6"W Gooseneck	8-1/2"	1.8 GPM
19-229L	8-1/2"W Gooseneck	10"	1.8 GPM



# Drains

**Krowne Drains** are available in many varieties, including Twist, Lever and **new Rotary Waste Valve** styles. We also offer standard kitchen and bar sink drains with optional overflows. Our drains are uniquely crafted from durable materials to resist harsh conditions in commercial environments. Many Krowne drains are universal so they are easy to install while providing consistent reliability.



**New**

## Rotary Twist Waste Valves

Features apply to all Rotary Twist Waste Valves

- Premium stainless steel ball valve design engineered for long-lasting performance
- Elimination of traditional rubber gasket to prevent leaks and withstand harsh conditions and chemicals
- Smooth, ¼ turn action for ease-of-use
- Overall lower maintenance costs due to ball valve design
- Universal 2" NPS male threaded drain outlet and 1-1/2" female threaded drain outlet



Stainless Steel Ball Valve shown closed



Stainless Steel Ball Valve shown halfway open



Stainless Steel Ball Valve shown open



**DIAMOND**  
series

### Stainless Steel Rotary Twist Waste Valve

- Fits 3-1/2" sink opening
- 1-1/4" overflow outlet with cap
- Stainless steel body
- Stainless steel ball valve
- Includes vandal resistant screw for strainer
- Approximately 2-3 times the drain rate of a conventional lever waste drain

**Model**  
**22-850**



**DIAMOND**  
series

### Short Handle Stainless Steel Rotary Twist Waste Valve

- Fits 3-1/2" sink opening
- 1-1/4" overflow outlet with cap
- Stainless steel body
- Shorter handle length
- Stainless steel ball valve
- Includes vandal resistant screw for strainer
- Approximately 2-3 times the drain rate of a conventional lever waste drain

**Model**  
**22-851**



### Nickel Plated Cast Bronze Rotary Twist Waste Valve

- Fits 3-1/2" sink opening
- 1-1/4" overflow outlet with cap
- Nickel plated cast bronze body
- Stainless steel ball valve
- Includes vandal resistant screw for strainer
- Approximately 2-3 times the drain rate of a conventional lever waste drain

**Model**  
**22-800**

### Replacement Parts for Rotary Twist Waste Valves

Model	Description
<b>22-508</b>	Repair Kit - Rubber & PVC Gaskets
<b>22-509</b>	Replacement Overflow Cap

Model	Description
<b>22-532</b>	Handle Replacement for 22-850
<b>22-533</b>	Short Handle Replacement for 22-851
<b>22-534</b>	Handle Replacement for 22-800

# Waste Valves

## 3-1/2" Twist Waste Valve

- Fits 3-1/2" sink opening
- 2" NPS Male Threaded / 1-1/2" Female Threaded Drain Outlet
- 1-1/4" overflow outlet
- Stainless steel strainer, flange and handle

Model	Case Qty.
22-204	12



**Most Popular**



## 3-1/2" Lever Waste Valve

- Fits 3-1/2" sink opening
- 2" NPS Male Threaded / 1-1/2" Female Threaded Drain Outlet
- 1-1/4" overflow outlet
- Stainless steel strainer, flange and handle

Model	Case Qty.
22-404	12



## 3" Twist Waste Valve

- Fits 3" sink opening
- 2" NPS Male Threaded / 1-1/2" Female Threaded Drain Outlet
- 1-1/4" overflow outlet
- Stainless steel strainer, flange and handle

Model	Case Qty.
22-201	12



## 3-1/2" Lever Waste Valve with Short 6" Handle

- Fits 3-1/2" sink opening
- 2" NPS Male Threaded / 1-1/2" Female Threaded Drain Outlet
- 1-1/4" overflow outlet
- Stainless steel strainer, flange and handle

Model	22-404-S
-------	----------



## 3-1/2" Twist Waste Valve with Short 6" Handle

- Fits 3-1/2" sink opening
- 2" NPS Male Threaded / 1-1/2" Female Threaded Drain Outlet
- 1-1/4" overflow outlet
- Stainless steel strainer, flange and handle

Model	22-204-S
-------	----------



## Waste Valve Installation Tool for Twist & Lever Waste Drains

- Fits most brands
- Heavy Duty

Model	22-540
-------	--------



# Waste Drain Replacement Parts & Accessories

## Twist Waste Drain Kit

- Includes 3-1/2" Twist Waste Drain (22-204), Overflow Head (22-500) & Overflow Elbow (22-501)
- 2" NPS Male Threaded / 1-1/2" Female Threaded drain outlet
- Fits 3-1/2" sink opening
- 1-1/4" overflow outlet
- Stainless steel strainer, flange and handle

**Model**  
**22-507**



22-507 fully assembled

## Optional Overflow Head and Elbow

- 2" cut-out in sink required for overflow head
- Interchangeable with most brands
- Reinforced spray head
- Full repair kits available

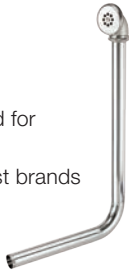

Model	Description
22-500	Overflow Head
22-501	Overflow Elbow
22-504	Head & Overflow Kit

## Replacement Face Strainer

- Fits all manufacturers



Model	Description
22-516	Fits 3" Sink Opening
22-616	Fits 3-1/2" Sink Opening

## Replacement Face Flange

- Fits all manufacturers
- Stainless Steel construction



Model	Description
22-515	Fits 3" Sink Opening
22-615	Fits 3-1/2" Sink Opening

## Replacement Stopper



- O-ring creates watertight seal
- Fits most brands

Model	Description
22-530	Complete Stopper
22-519	O-Ring Only

## Replacement Overflow Cap

- Fits all twist and rotary waste drains
- Nickel Plated Brass



**Model**  
**22-505**

## Reducer

- Converts 2" NPS fitting on all waste drains to 1-1/2" NPS male
- Nickel plated brass
- Fits all twist and rotary waste drains



**Model**  
**22-503**

## Lever Handle Assembly



- Fits all Lever Waste Drains

**Model**  
**22-528**

## Twist Handle Assembly



- Fits all Twist Waste Drains

**Model**  
**22-529**

## Twist & Lever Drain Repair Kit

- Fits most brands
- Fits all waste drains



**Model**  
**22-502**

## 3-1/2" Stainless Steel Drains



Model  
23-123

### Standard Kitchen Sink Drain

- For 3-1/2" sink opening
- 4-1/2" top diameter
- 1-1/2" NPS male
- Locknut and washer included
- Stainless steel with metal post
- Used on all kitchen sinks



### Fixed Metal Post Basket

- Fits 3-1/2" kitchen drains
- Fits Krowne drain models 23-123 and 23-130

Model  
23-153



### Movable Metal Post Basket

- Fits 3-1/2" kitchen drains
- Fits Krowne drain models 23-123 and 23-130

Model  
23-138



Model  
23-130

### Long Shank Stainless Steel Sink Strainer

- Stainless steel construction
- Fits 3-1/2" - 4" sink openings
- 4-1/2" flange
- Deep basket for added capacity
- Brass nut on bottom



### Strainer Basket

- Fits 3-1/2" kitchen drains
- Does not stop water flow

Model  
23-159

## 1-1/2" Stainless Steel Drains



Model  
23-121

### 1-1/2" Full Flange Stainless Steel Drain

- For 1-1/2" sink opening
- 2-1/2" top diameter
- 1-1/2" NPT male
- Locknut and washer included
- Used on Krowne "HS" hand sinks



Model  
23-152

### Replacement Basket

- Fits 1-1/2" stainless steel drains
- Fits Krowne drain models 23-121 and 23-122



Model  
23-122

### 1-1/2" Cut Flange Stainless Steel Drain

- For 1-1/2" sink opening with small flange
- 2-1/2" top diameter
- 1-1/2" NPT male
- Locknut and washer included
- Fits all Krowne sinks 2017 and prior
- Fits all manufacturers

## 1" Plastic Drain



### 1" Plastic Drain with Metal Locknut

- Fits 1-3/8" opening
- 1" NPS male thread, 2" flange size
- 1-1/2" long
- Locknut and washer included

Model  
23-111-A

## Heavy Cast Drains



Model  
23-110

### 1/2" Nickel Plated Brass Drain

- Fits 15/16" opening
- 1/2" NPS male thread
- 1-1/8" flange size
- 1-1/2" long
- Locknut and washer included



Model  
23-111

### 1" Nickel Plated Brass Drain

- Fits 1-3/8" opening
- 1" NPS male thread
- 2" flange size
- 1-1/2" long
- Locknut and washer included



Model  
23-120

### 1-1/4" Slanted Top Drain (Krowne 1997 to 2016)

- For 1-1/4" sink and ice bin openings
- Tapered top
- 1" NPT male thread
- Locknut and washer included
- Uses 23-155 overflow

# Overflow Pipes



**Most Popular**

## 1-1/2" Metal Overflow Pipe for Bar Sinks

- 1-1/2" Overflow Pipe
- Fits most manufacturers

Model  
**23-156**

Fits 1-1/2" Drains



23-121

23-122



## Universal Stainless Overflow Pipe for Bar Sinks

- Fits all 1", 1-1/4" and 1-1/2" Drains
- Heavy Duty Rubber Grommet

Model Case Qty.  
**23-151 12**

Fits 1", 1-1/4" and 1-1/2" Drains



23-111

23-120

23-121



## Universal Plastic Overflow Pipe for Bar Sinks

- Fits all 1", 1-1/4" and 1-1/2" Drains
- Heavy Duty Rubber Grommet

Model Case Qty.  
**23-150 12**

Fits 1", 1-1/4" and 1-1/2" Drains



23-111

23-120

23-121



## 1-1/4" Metal Overflow Pipe for Bar Sinks

- 1-1/4" Overflow Pipe
- Fits old style Krowne slanted top drains

Model  
**23-155**

Fits 1-1/4" Slanted Top Drains



23-120



## 1" Metal Overflow Pipe for Bar Sinks

- 1" Overflow Pipe
- Fits 1" Drains

Model  
**23-154**

Fits 1" Drain



23-111



# Hand Sinks

**Krowne Hand Sinks** are designed for a multitude of unique applications. Most models come standard with a quarter turn ceramic faucet, drain, and wall bracket. There are various sizes to choose from including 16" wide, 12" wide, and 9" wide.

Our Hand Sinks are also offered with side splashes, soap and towel dispensers, electronic faucets, and manual faucets. No matter the requirements, Krowne has a hand sink option to fulfill your needs and satisfy local health codes.

# 16" Wide Hand Sinks

All Krowne Hand Sinks include Faucet, Drain & Wall Bracket (unless specified)

## 16" Hand Sink

- 10-435L faucet with 1/4 turn ceramic valves (0.5 GPM)
- 1-1/2" Drain



Model	Overall Size	Bowl	Weight
<b>HS-2L</b>	16"W x 15"D x 14"H	6" Deep	13

## 16" with Royal Series Faucet

- Includes Royal Series Faucet with 1/4 turn ceramic cartridge valves
- 1-1/2" Drain

21-308L (cold) and 21-309L (hot) replacement valves



Model	Overall Size	Bowl	Weight
<b>HS-22</b>	16"W x 15"D x 14"H	6" Deep	16

## 16" with Side Support Brackets

- Side support brackets on each side
- 10-435L faucet with 1/4 turn ceramic valves (0.5 GPM)
- 1-1/2" Drain



Model	Overall Size	Bowl	Weight
<b>HS-10</b>	16"W x 15"D x 20"H	6" Deep	16

## 16" with Wrist Blades Handles

- 10-435L-W faucet with 1/4 turn ceramic valves (0.5 GPM)
- 1-1/2" Drain



Model	Overall Size	Bowl	Weight
<b>HS-43</b>	16"W x 15"D x 14"H	6" Deep	14

## 16" with Overflow Drain & P-Trap

- 10-435L faucet with 1/4 turn ceramic valves (0.5 GPM)
- Overflow drain and P-Trap included
- 1-1/2" Drain
- Weight: 16 lbs.



Model	Overall Size	Bowl
<b>HS-4</b>	16"W x 15"D x 14"H	6" Deep

## 14-1/2" Wide with Deck Mount Faucet

- 11-435L deck mount faucet with 1/4 turn ceramic valves (0.5 GPM)
- 1-1/2" Drain



Model	Overall Size	Bowl	Weight
<b>HS-18</b>	14-1/2"W x 16-1/2"D x 14"H	6" Deep	13

### REPLACEMENT PARTS & ACCESSORIES

**Model 10-435L**  
4" Center Faucet with 4-1/2" Double Bend Spout

**Model 21-300L**  
1/4 Turn Ceramic Valves

**Model 23-121**  
1-1/2" Drain (Locknut and Washer Included)

**Model 21-443L**  
E-Z Install Flexible Water Line Kit



## 16" Wide with Side Splashes

All Krowne Hand Sinks include Faucet, Drain & Wall Bracket (unless specified)

### 16" with Side Splashes

- 7-3/4"H Side Splashes
- 10-435L faucet with 1/4 turn ceramic valves (0.5 GPM)
- 1-1/2" Drain
- Weight: 15 lbs.



Model	Overall Size	Bowl
<b>HS-26L</b>	16"W x 15"D x 14"H	6" Deep

### 16" with Right Side Splash

- 7-3/4"H Side Splash on right side
- 10-435L faucet with 1/4 turn ceramic valves (0.5 GPM)
- 1-1/2" Drain
- Weight: 14 lbs.



Model	Overall Size	Bowl
<b>HS-2-RS</b>	16"W x 15"D x 14"H	6" Deep

### 16" with Left Side Splash

- 7-3/4"H Side Splash on left side
- 10-435L faucet with 1/4 turn ceramic valves (0.5 GPM)
- 1-1/2" Drain
- Weight: 14 lbs.



Model	Overall Size	Bowl
<b>HS-2-LS</b>	16"W x 15"D x 14"H	6" Deep

### 16" with Side Splashes & P-Trap

- 7-3/4"H Side Splashes
- P-Trap
- 10-435L faucet with 1/4 turn ceramic valves (0.5 GPM)
- 1-1/2" Drain
- Weight: 15 lbs.



Model	Overall Size	Bowl
<b>HS-5</b>	16"W x 15"D x 24"H	6" Deep



### 16" with Side Splashes Less Faucet

- 7-3/4"H Side Splashes
- 4" Center Faucet Holes
- No faucet included
- 1-1/2" Drain
- Weight: 11 lbs.

Model	Overall Size	Bowl
<b>HS-26-LF</b>	16"W x 15"D x 14"H	6" Deep

#### REPLACEMENT PARTS & ACCESSORIES



Model  
**10-435L**  
4" Center Faucet with  
4-1/2" Double Bend Spout



Model  
**21-300L**  
1/4 Turn Ceramic Valves



Model  
**23-121**  
1-1/2" Drain (Locknut  
and Washer Included)



Model  
**21-443L**  
E-Z Install Flexible Water  
Line Kit

# 16" Wide with Electronic Faucet

All Krowne Hand Sinks include Faucet, Drain & Wall Bracket (unless specified)

## 16" with 4" Center Electronic Sensor Faucet

- 16"W x 15"D x 14"H
- 6" Deep Bowl
- 16-670 electronic sensor faucet (2.2 GPM)
- 1-1/2" Drain



Model	Features	Weight
<b>HS-67</b>	No Side Splashes	18
<b>HS-68</b>	With Side Splashes	21

## 16" with Single Hole Electronic Sensor Faucet

- 16"W x 15"D x 14"H
- 6" Deep Bowl
- 16-675 electronic sensor faucet (1.0 GPM)
- 1-1/2" Drain



Model	Features	Weight
<b>HS-69</b>	No Side Splashes	16
<b>HS-70</b>	With Side Splashes	19

## 16" with Single Hole Electronic Sensor Faucet

- 16-190 electronic sensor faucet (2.2 GPM)
- 1-1/2" Drain
- Weight: 14 lbs.



Model	Overall Size	Bowl
<b>HS-11</b>	16"W x 15"D x 14"H	6" Deep

## 16" with Single Hole Electronic Sensor Faucet, Overflow & P-Trap

- 16-190 electronic sensor faucet (2.2 GPM)
- Includes Overflow & P-Trap
- 1-1/2" Drain
- Weight 15 lbs.



Model	Overall Size	Bowl
<b>HS-12</b>	16"W x 15"D x 14"H	6" Deep

## 16" with Single Hole Electronic Sensor Faucet, Overflow & P-Trap, and Soap & Towel Dispenser

- 16-190 electronic sensor faucet (2.2 GPM)
- Includes Overflow & P-Trap
- Built-in Soap & Towel Dispenser
- 1-1/2" Drain
- Weight 30 lbs.



Model	Overall Size	Bowl
<b>HS-13</b>	16"W x 15"D x 24"H	6" Deep

### REPLACEMENT PARTS & ACCESSORIES FOR HAND SINKS WITH ELECTRONIC FAUCETS



Model **H-100**  
Chrome Plated P-Trap



Model **23-123**  
3-1/2" Drain with Strainer



Model **23-121**  
1-1/2" Drain (Locknut and Washer Included)



Model **16-198**  
AC Adapter

# 16" Wide with Soap & Towel

All Krowne Hand Sinks include Faucet, Drain & Wall Bracket (unless specified)

## 16" with Overflow & P-Trap and Soap & Towel Dispenser

- 16"W x 15"D x 24"H
- 6" Deep Bowl
- Includes Overflow & P-Trap
- Built-in Soap & Towel Dispenser
- 10-435L faucet with 1/4 turn ceramic valves (0.5 GPM)
- 1-1/2" Drain

Model	Features	Weight
HS-7	No Side Splashes	35
HS-33	With Side Splashes	38



## 16" with Stainless Steel Skirt, Overflow & P-Trap and Soap & Towel Dispenser

- Stainless Steel Skirt
- Includes Overflow & P-Trap
- Built-in Soap & Towel Dispenser
- 10-435L faucet with 1/4 turn ceramic valves (0.5 GPM)
- 1-1/2" Drain
- Weight 35 lbs.

Model	Overall Size	Bowl
HS-8	16"W x 15"D x 24"H	6" Deep



## 16" with Side Supports, Overflow & P-Trap and Soap & Towel Dispenser

- Two Side Supports on each side
- Includes Overflow & P-Trap
- Built-in Soap & Towel Dispenser
- 10-435L faucet with 1/4 turn ceramic valves (0.5 GPM)
- 1-1/2" Drain
- Weight 35 lbs.

Model	Overall Size	Bowl
HS-58	16"W x 15"D x 24"H	6" Deep



## 16" with Soap & Towel Dispenser

- Built-in Soap & Towel Dispenser
- 10-435L faucet with 1/4 turn ceramic valves (0.5 GPM)
- 1-1/2" Drain
- Weight 35 lbs.

Model	Overall Size	Bowl
HS-56	16"W x 15"D x 24"H	6" Deep



### REPLACEMENT PARTS & ACCESSORIES



# 16" Wide with Knee Pedal Valve

All Krowne Hand Sinks include Faucet, Drain & Wall Bracket (unless specified)

## 16" with Knee Pedal Valve

- Knee pedal faucet w/ built-in flow control on hot and cold valves
- 16-140L faucet (1.8 GPM)
- 1-1/2" Drain
- Weight: 26 lbs.



Model	Overall Size	Bowl
<b>HS-15</b>	16"W x 15"D x 19-1/2"H	6" Deep

## 16" with Knee Pedal Valve & Side Splashes

- Knee pedal faucet w/ built-in flow control on hot and cold valves
- Side splashes on both sides
- 16-140L faucet (1.8 GPM)
- 1-1/2" Drain
- Weight 26 lbs.



Model	Overall Size	Bowl
<b>HS-41</b>	16"W x 15"D x 19-1/2"H	6" Deep

## 16" with Knee Pedal Valve and Soap & Towel Dispenser

- Knee pedal faucet with built-in flow control on hot and cold valves
- Built-in Soap & Towel Dispenser
- 16-140L faucet (1.8 GPM)
- 1-1/2" Drain
- Weight 36 lbs.



Model	Overall Size	Bowl
<b>HS-16</b>	16"W x 15"D x 24"H	6" Deep

# 16" Wide Pedestal with Foot Valve

All Krowne Hand Sinks include Faucet, Drain & Wall Bracket (unless specified)

## 16" Pedestal with Foot Valve

- 16"W x 15"D x 42"H
- 6" Deep Bowl
- Foot pedal faucet with built-in flow control on hot and cold valves
- Deck mount soap dispenser (only included on model HS-14)
- 16-140L faucet (1.8 GPM)
- 1-1/2" Drain



HS-14

Model	Features	Weight
<b>HS-14</b>	No Side Splashes	35
<b>HS-40</b>	With Side Splashes	38

## 16" Pedestal with Foot Valve and Soap & Towel Dispenser

- 16"W x 15"D x 42"H
- 6" Deep Bowl
- Foot pedal faucet with built-in flow control on hot and cold valves
- HS-39 has Deck Mount Soap Dispenser
- HS-42 has Wall Mount Soap Dispenser
- 16-140L faucet (1.8 GPM)
- 1-1/2" Drain



HS-39

Model	Features	Weight
<b>HS-39</b>	No Side Splashes	50
<b>HS-42</b>	With Side Splashes	53

### REPLACEMENT PARTS & ACCESSORIES

Model  
**16-406L**

Knee Pedal Valve



Model  
**16-407L**

Foot Pedal Valve



Model  
**23-121**

1-1/2" Drain (Locknut and Washer Included)



Model  
**16-140L**

Single Hole Wall Mount Spout



# 16" Wide Less Faucet

All Krowne Hand Sinks include Faucet, Drain & Wall Bracket (unless specified)



## 16" with 4" Center Faucet Holes Less Faucet

- 4" Center Faucet Holes
- No faucet included
- 16"W x 15"D x 14"H overall size
- 6" Deep Bowl
- 1-1/2" Drain
- Weight: 11 lbs.

Model

**HS-2-LF**



## 16" with Single Faucet Hole Less Faucet

- Single Faucet Hole
- No faucet included
- 16"W x 15"D x 14"H overall size
- 6" Deep Bowl
- 1-1/2" Drain
- Weight: 11 lbs.

Model

**HS-11-LF**



## 16" with 8" Center Faucet Holes Less Faucet

- 8" Center Faucet Holes
- No faucet included
- 16"W x 15"D x 14"H overall size
- 6" Deep Bowl
- 3-1/2" Drain
- Weight: 11 lbs.

Model

**HS-20-LF**



## 14-1/2" Wide with 4" Center Deck Faucet Holes Less Faucet

- 4" Center Deck Faucet Holes
- No faucet included
- 14-1/2"W x 16-1/2"D x 14"H overall size
- 6" Deep Bowl
- 1-1/2" Drain
- Weight: 11 lbs.

Model

**HS-18-LF**

### REPLACEMENT PARTS & ACCESSORIES



Model  
**H-100**

Chrome Plated P-Trap



Model  
**21-300L**

1/4 Turn Ceramic Valves



Model  
**23-121**

1-1/2" Drain (Locknut and Washer Included)



Model  
**21-443L**

E-Z Install Flexible Water Line Kit

## 12" Wide Hand Sinks

All Krowne Hand Sinks include Faucet, Drain & Wall Bracket (unless specified)

### 12" Hand Sink

- 12"W x 17"D x 14"H
- 6" Deep Bowl.
- 10-435L faucet with 1/4 turn ceramic valves (0.5 GPM)
- 1-1/2" Drain
- Weight 12 lbs.

**Model**  
**HS-9L**



### 12" with Royal Series Faucet

- 12"W x 17"D x 14"H
- 6" Deep Bowl
- Faucet with 1/4 turn ceramic cartridge valves
- 1-1/2" Drain
- Weight 15 lbs.

**Model**  
**HS-21**



## 12" Wide with Side Splashes

All Krowne Hand Sinks include Faucet, Drain & Wall Bracket (unless specified)



### 12" with Side Splashes

- 7-3/4"H Side Splashes
- 10-435L faucet with 1/4 turn ceramic valves (0.5 GPM)
- 1-1/2" Drain
- Weight 15 lbs.

**Model**      **Overall Size**      **Bowl**  
**HS-30L**    12"W x 17"D x 14"H    6" Deep



### 12" with Right Side Splash

- 7-3/4"H Side Splash on right side
- 10-435L faucet with 1/4 turn ceramic valves (0.5 GPM)
- 1-1/2" Drain
- Weight 14 lbs.

**Model**      **Overall Size**      **Bowl**  
**HS-9-RS**    12"W x 17"D x 14"H    6" Deep



### 12" with Left Side Splash

- 7-3/4"H Side Splash on left side
- 10-435L faucet with 1/4 turn ceramic valves (0.5 GPM)
- 1-1/2" Drain
- Weight 14 lbs.

**Model**      **Overall Size**      **Bowl**  
**HS-9-LS**    12"W x 17"D x 14"H    6" Deep

## REPLACEMENT PARTS & ACCESSORIES



**Model**  
**10-435L**

4" Center Faucet with  
4-1/2" Double Bend Spout



**Model**  
**21-300L**

1/4 Turn Ceramic Valves



**Model**  
**23-121**

1-1/2" Drain (Locknut  
and Washer Included)



**Model**  
**21-443L**

E-Z Install Flexible Water  
Line Kit

## 12" Wide with Electronic Faucet

All Krowne Hand Sinks include Faucet, Drain & Wall Bracket (unless specified)

### 12" with 4" Center Electronic Sensor Faucet

- 16-670 electronic sensor faucet (2.2 GPM)
- 1-1/2" Drain
- Weight 17 lbs.



Model	Overall Size	Bowl
<b>HS-64</b>	12"W x 17"D x 14"H	6" Deep

### 12" with 4" Center Electronic Sensor Faucet & Side Splashes

- 7-3/4"H Side Splashes
- 16-670 electronic sensor faucet (2.2 GPM)
- 1-1/2" Drain
- Weight 17 lbs.



Model	Overall Size	Bowl
<b>HS-65</b>	12"W x 17"D x 14"H	6" Deep

## 12" Wide Less Faucet

All Krowne Hand Sinks include Faucet, Drain & Wall Bracket (unless specified)



### 12" with 4" Center Faucet Holes

- 12"W x 17"D x 14"H
- 6" Deep Bowl
- 4" Center Faucet Holes
- 1-1/2" Drain
- Weight 11 lbs.

Model
<b>HS-9-LF</b>



### 12" with Single Faucet Hole

- 12"W x 17"D x 14"H
- 6" Deep Bowl
- Single Faucet Hole
- 1-1/2" Drain
- Weight 11 lbs.

Model
<b>HS-9S-LF</b>



### 12" with 4" Center Faucet Holes & Side Splashes

- 12"W x 17"D x 14"H
- 6" Deep Bowl
- 4" Center Faucet Holes
- 7-3/4"H Side Splashes
- 1-1/2" Drain
- Weight 13 lbs.

Model
<b>HS-30-LF</b>

### REPLACEMENT PARTS & ACCESSORIES



Model  
**10-435L**  
4" Center Faucet with  
4-1/2" Double Bend Spout



Model  
**16-670**  
4" Center Electronic  
Sensor Faucet



Model  
**23-121**  
1-1/2" Drain (Locknut  
and Washer Included)



Model  
**21-300L**  
1/4 Turn Ceramic Valves

# 12" Wide Hand Sinks with Soap & Towel

All Krowne Hand Sinks include Faucet, Drain & Wall Bracket (unless specified)



## 12" with Soap & Towel Dispenser and Overflow & P-Trap

- Includes Overflow & P-Trap
- Built-in Soap & Towel Dispenser
- 10-435L faucet with 1/4 turn ceramic valves (0.5 GPM)
- 1-1/2" Drain
- Weight 30 lbs.

Model	Overall Size	Bowl
<b>HS-31</b>	12"W x 17"D x 24"H	6" Deep



## 12" with Soap & Towel Dispenser, Overflow & P-Trap, and Side Splashes

- 7-3/4"H Side Splashes
- Includes Overflow & P-Trap
- Built-in Soap & Towel Dispenser
- 10-435L faucet with 1/4 turn ceramic valves (0.5 GPM)
- 1-1/2" Drain
- Weight 35 lbs.

Model	Overall Size	Bowl
<b>HS-32</b>	12"W x 17"D x 24"H	6" Deep



## 12" with Soap & Towel Dispenser, Overflow & P-Trap, and Stainless Steel Skirt

- Includes Overflow & P-Trap
- Built-in Soap & Towel Dispenser
- Stainless Steel Skirt
- 10-435L faucet with 1/4 turn ceramic valves (0.5 GPM)
- 1-1/2" Drain
- Weight 33 lbs.

Model	Overall Size	Bowl
<b>HS-37</b>	12"W x 17"D x 24"H	6" Deep

### REPLACEMENT PARTS & ACCESSORIES



Model **10-435L**  
4" Center Faucet with 4-1/2" Double Bend Spout



Model **21-300L**  
1/4 Turn Ceramic Valves



Model **23-121**  
1-1/2" Drain (Locknut and Washer Included)



Model **21-443L**  
E-Z Install Flexible Water Line Kit



## 9" Wide Space Saver Hand Sinks

All Krowne Hand Sinks include Faucet, Drain & Wall Bracket (unless specified)

### 9" MiniMax Hand Sink

- 10-435L faucet with 1/4 turn ceramic valves (0.5 GPM)
- 1-1/2" Drain
- Weight 14 lbs.

Model	Overall Size	Bowl
<b>HS-1</b>	9"W x 12"D x 13"H	6" Deep



### 9" MiniMax Hand Sink with Side Splashes

- 10-435L faucet with 1/4 turn ceramic valves (0.5 GPM)
- 1-1/2" Drain
- Weight 14 lbs.

Model	Overall Size	Bowl
<b>HS-19</b>	9"W x 12"D x 13"H	6" Deep



## 9" Wide Space Saver Hand Sinks with Electronic Faucet

All Krowne Hand Sinks include Faucet, Drain & Wall Bracket (unless specified)

### 9" MiniMax with 4" Center Electronic Sensor Faucet

- 16-670 electronic sensor faucet (2.2 GPM)
- 1-1/2" Drain
- Weight 17 lbs

Model	Overall Size	Bowl
<b>HS-61</b>	9"W x 12"D x 13"H	6" Deep



Optional AC Adapter: **16-199**

### 9" MiniMax with 4" Center Electronic Sensor Faucet & Side Splashes

- 7-3/4"H Side Splashes
- 16-670 electronic sensor faucet (2.2 GPM)
- 1-1/2" Drain
- Weight 17 lbs

Model	Overall Size	Bowl
<b>HS-62</b>	9"W x 12"D x 13"H	6" Deep



Optional AC Adapter: **16-199**

### REPLACEMENT PARTS & ACCESSORIES



# ADA Compliant Hand Sinks

All ADA Compliant Hand Sinks include a faucet, wall bracket & two side supports.



## 4" Center Deck Mount With Wrist Blades

- 4" Center Deck Mount Faucet with 6" Double Bend Spout (1.8 GPM)
- Deck Mount Soap Dispenser
- 1-1/2" Drain
- Weight 24 lbs.

Model	Overall Size	Bowl
<b>HS-50</b>	20"W x 24"D x 16"H	5" Deep



## Single Hole Hands Free Electronic Faucet

- 16-650 Electronic Faucet with 6" Gooseneck Spout (2.2 GPM)
- Deck Mount Soap Dispenser
- 1-1/2" Drain
- Weight 24 lbs.

Model	Overall Size	Bowl
<b>HS-51</b>	20"W x 24"D x 16"H	5" Deep



## 8" Center Deck Mount With Wrist Blades

- 8" Center Deck Mount Faucet with 6" Double Bend Spout (1.8 GPM)
- 1-1/2" Drain
- Weight 26 lbs.

Model	Overall Size	Bowl
<b>HS-53</b>	20"W x 24"D x 16"H	5" Deep

# Specialty Hand Sinks

All Krowne Hand Sinks include Faucet, Drain & Wall Bracket (unless specified)



## 16" Hands Free Faucet Wand

- Faucet with push back activation
- 10-435L faucet with 1/4 turn ceramic valves (0.5 GPM)
- 1-1/2" Drain
- Weight 14 lbs.

Model	Overall Size	Bowl
<b>HS-34</b>	16"W x 15"D x 14"H	6" Deep



## 12" Eyewash Station

- Eye wash included (16-232L)
- 10-435L faucet with 1/4 turn ceramic valves (0.5 GPM)
- 1-1/2" Drain
- Weight 15 lbs.

Model	Overall Size	Bowl
<b>HS-35</b>	12"W x 17"D x 14"H	6" Deep



## 16" Eyewash Station

- Eye wash included (16-232L)
- 10-435L faucet with 1/4 turn ceramic valves (0.5 GPM)
- 1-1/2" Drain
- Weight 15 lbs.

Model	Overall Size	Bowl
<b>HS-36</b>	16"W x 15"D x 14"H	6" Deep

### REPLACEMENT PARTS & ACCESSORIES



# Hand Sink Parts & Accessories



## Automatic Wall Mount Soap/Sanitizer Dispenser

For Liquid Soap or Sanitizer

- Touch-free sensor
- Mounting screws included
- Safety lock with key
- Refillable soap container with site window
- Uses 4 C Batteries (not included)

**New** | Model **H-121**



## Automatic Wall Mount Foam Soap Dispenser

For Foam Soap

- Touch-free sensor
- Mounting screws included
- Safety lock with key
- Refillable soap container with site window
- Uses 4 C Batteries (not included)

**New** | Model **H-122**



## Manual Wall Mount Soap/Sanitizer Dispenser

For Liquid Soap or Sanitizer

- Mounting screws included
- Safety lock with key
- Refillable soap container with site window

**New** | Model **H-145**



## Soap Dispenser Drip Tray

- For Wall Mount Automatic Liquid Soap/Sanitizer and Foam Soap Dispensers (H-121 and H-122)
- Adhesive backing

**New** | Model **H-160**



## Soap Dispenser Countertop Stand

- For Wall Mount Automatic Liquid Soap/Sanitizer and Foam Soap Dispensers (H-121 and H-122)
- Can be used with H-160 Soap Dispenser Drip Tray

**New** | Model **H-162**



## Soap Dispenser Floor Stand

- For Wall Mount Automatic Liquid Soap/Sanitizer and Foam Soap Dispensers (H-121 and H-122)
- Recommended pairing the H-160 Soap Dispenser Drip Tray with this item

**New** | Model **H-165**



## Soap & Towel Dispenser Combo

- Uses 7-1/2" x 11-3/4" tri-fold paper towels

Model	Description
<b>H-111</b>	16"W Soap & Towel Dispenser
<b>H-115</b>	12"W Soap & Towel Dispenser

Soap & Towel Dispenser mounts above hand sink ▶



H-116



H-101

## Soap Dispensers

Model	Description
<b>H-116</b>	Wall Mount Soap Dispenser (30 oz)
<b>H-101</b>	Deck Mount Soap Dispenser 13 oz. (Fits 1-1/8" opening)



## Towel Dispensers

- Wall Mount
- 11"W x 15"H x 4"D
- Uses tri-fold paper towels

Model **H-105**

# Hand Sink Parts & Accessories



## Single Pedal Valves

- Built-in flow control on hot and cold valves
- Self closing valve
- Repair kit available
- Built-in check valves
- Adjust temperature by using flow control valves
- Mounting screws not included
- Repair Kit for 1 Hot or Cold Valve available (Model 21-302L)

Model	Description
<b>16-407L</b>	Single Pedal Foot Valve
<b>16-406L</b>	Single Pedal Knee Valve



## Double Pedal Valves

- Self closing valve
- Repair kit available
- Color-coded knee pedals
- 4-1/2" hole centers
- Mounting screws not included
- Repair Kit for 1 Hot or Cold Valve available (Model 21-302L)

Model	Description
<b>16-120L</b>	Double Pedal Foot Valve
<b>16-121L</b>	Double Pedal Knee Valve

## Field Installed Side Splashes

- Fits hand sinks with 15" front to back depth
- Easy to install in the field
- Does not require screws
- Pre-applied industrial strength double-sided tape
- Silicone sealant included



Model	Splash Location
<b>SG-L2</b>	Left Side
<b>SG-R2</b>	Right Side
<b>SG-LR2</b>	Left & Right Side

## Factory Installed Side Splashes

- Fits hand sinks with 15" front to back depth
- Spot welded to side of hand sink
- Sealed with silicone to meet local health code requirements



Model	Splash Location
<b>FG-L2</b>	Left Side
<b>FG-R2</b>	Right Side
<b>FG-LR2</b>	Left & Right Side

## Stainless Steel Skirts



- Factory installed
- Sink not included

Model	Description
<b>H-108-2</b>	16"W x 15"D
<b>H-108-9</b>	12"W x 17"D
<b>H-108-1</b>	9"W x 12"D



## Spout-Mount Eyewash

- Fits all spouts
- Hand sink & faucet not included

<b>Model</b>	<b>16-232L</b>
--------------	----------------



## Side Support Brackets

- For added strength

<b>Model</b>	<b>H-110</b>
--------------	--------------



## Wall Bracket

Model	Size
<b>WB-1715</b>	16"W
<b>WB-1712</b>	12"W



## Hands-Free Spout Valve

- Spring loaded for automatic closure
- Dual position for continuous flow
- Simple screw-on installation

<b>Model</b>	<b>21-451</b>
--------------	---------------



## Replacement Wall Mount Faucet

- 4" center wall mount
- 1/4 turn ceramic valves
- 4-1/2" Double Bend Spout

<b>Model</b>	<b>10-435L</b>
--------------	----------------



## Handle Repair Kits



Model	Description
<b>21-300L</b>	Faucet Repair Kit
<b>21-311</b>	Wrist Handle Kit



## Chrome Plated P-Trap

- 1-1/2" IPS

<b>Model</b>	<b>H-100</b>
--------------	--------------

## Overflow Assembly

- Includes hose, clamps & overflow inlet

<b>Model</b>	<b>23-157</b>
--------------	---------------



## 1-1/2" Drain

- Fits 1-1/2" sink opening
- 1-1/2" NPS male

<b>Model</b>	<b>23-121</b>
	Locknut & washer included



## E-Z Install Hoses

Model	Description
<b>21-443L</b>	E-Z Install Flexible Water Line Kit
<b>21-198L</b>	1/2" x 3/8" Braided Supply Hoses



## One Compartment Drop-In Sinks

All Krowne Drop-In Hand Sinks include Faucet & Drain (unless specified)

### 15" x 15" Overall Drop-In Sink

- 15" x 15" overall
- 12"W x 10"D x 5-3/16" Deep Bowl
- Cutout: 14-3/8" x 14-3/8"
- 11-435L faucet with 1/4 turn ceramic valves (0.5 GPM)
- 1-1/2" Drain



Model	Weight
<b>HS-1515</b>	8 lbs.

### 13" x 17-1/2" Overall Drop-In Sink

- 13" x 17-1/2" overall
- 11"W x 13-1/2"D x 6-3/8" Deep Bowl
- Cutout: 11-1/2" x 16"
- 11-435L faucet with 1/4 turn ceramic valves (0.5 GPM)
- 1-1/2" Drain



Model	Weight
<b>HS-1317</b>	8 lbs.

### 20-1/4" x 17" Overall Drop-In Sink

- 20-1/4" x 17" overall
- 17-3/4"W x 12-3/4"D x 7-1/2" Deep bowl
- Cutout: 18-1/4" x 15-1/2"
- 11-460L faucet with 1/4 turn ceramic valves (1.8 GPM)
- 1-1/2" Drain



Model	Weight
<b>HS-2017</b>	8 lbs.

### 10" x 16" Overall Drop-In Sinks

- 10" x 16" overall
- 8"W x 12"D x 10" Deep bowl
- 11-460L faucet with 1/4 turn ceramic valves (1.8 GPM)
- 3-1/2" Drain



Model	Description
<b>HS-1016</b>	No Side Splashes
<b>HS-1025</b>	With Side Splashes

### 12" x 18" Overall Drop-In Sinks

- HS-1419: 10"W x 14"D x 10" Deep bowl
- HS-1425: 10"W x 14"D x 5" Deep bowl
- Cutout: 10-1/2" x 16-3/4"
- 11-460L faucet with 1/4 turn ceramic valves (1.8 GPM)
- 3-1/2" Drain



HS-1419

Model	Description
<b>HS-1419</b>	10" Deep Bowl
<b>HS-1425</b>	5" Deep Bowl

### 12" x 18" Overall with Side Splashes

- HS-1220 bowl size: 10"W x 14"D x 10" Deep
- HS-1225 bowl size: 10"W x 14"D x 5" Deep
- Cutout: 10-1/2" x 16-3/4"
- 5-1/2"H Splashes
- 11-460L faucet with 1/4 turn ceramic valves (1.8 GPM)
- 3-1/2" Drain



HS-1220

Model	Description
<b>HS-1220</b>	10" Deep Bowl
<b>HS-1225</b>	5" Deep Bowl

#### REPLACEMENT PARTS & ACCESSORIES



Model	Description
<b>11-460L</b>	4" Center Faucet with 6" Double Bend Spout



Model	Description
<b>11-435L</b>	4" Center Faucet with 4-1/2" Double Bend Spout



Model	Description
<b>21-300L</b>	1/4 Turn Ceramic Valves



Model	Description
<b>23-121</b>	1-1/2" Drain (Locknut and Washer Included)



Model	Description
<b>23-123</b>	3-1/2" Drain (Locknut and Washer Included)



Model	Description
<b>21-198L</b>	1/2" x 3/8" Braided Supply Hoses

## Multiple Compartment Drop-In Sinks

All Krowne Drop-In Hand Sinks include Faucet & Drain (unless specified)



▲ Two Compartment  
26" x 18" Overall  
Drop-In Sink

◀ Three Compartment  
36" x 18" Overall  
Drop-In Sink

- 10"W x 14"D x 10" deep bowls
- Faucet with 1/4 turn ceramic valves, 1.8 GPM - Faucet only included on models HS-2619 (8" spout) and HS-3819 (12" spout)
- 3-1/2" drains in each bowl

Model	Bowls	Faucet	Overall Size	Cutout	Wgt.
HS-2619	2	Included	26" x 18"	22-1/4" x 16-3/4"	30
HS-2619-LF	2	No Faucet	26" x 18"	22-1/4" x 16-3/4"	30
HS-3819	3	Included	36" x 18"	34-1/4" x 16-3/4"	45
HS-3819-LF	3	No Faucet	36" x 18"	34-1/4" x 16-3/4"	45

**New**

## Scullery Sinks

- Bowl Size: 18"W x 18"L x 13"D
- 3-1/2" Drain included
- 18 gauge stainless steel sink
- 304 stainless steel legs with plastic bullet feet
- 12-808L faucet with 1/4 turn ceramic valves, 1.8 GPM (included on BS-1818)



BS-1818

Model	Description
BS-1818	Includes Faucet
BS-1818-LF	Less Faucet

### Replacement Drain

3-1/2" Drain Fits  
Multi-Compartment Drop-In  
Sinks or Scullery Sinks



Model  
**23-123**  
Locknut  
and Washer  
Included

## Specialty Sinks on Legs

Specialty Sinks include Faucet & Drain (unless specified)



### Dump Sink

- 10"W x 14"D x 7" deep bowl
- 10-406L faucet with 1/4 turn ceramic valves (1.8 GPM)
- 1-1/2" drain
- Weight: 40 lbs.

Model	Width	Depth	Wgt.
18-1C	12"	18-1/2"	33



### Convenience Store Sinks

- 19" front to back x 36" working height
- 3-1/2" basket drains
- 10-410L faucet with 1/4 turn ceramic valves (1.8 GPM)
- 10"W x 14"D x 10"H bowl

Model	Width	Drainboard	Wgt.
CS-1836	36"	-	69
CS-1860	60"	(2) 12" ea.	85
CS-1872	72"	(2) 18" ea.	95



### Sinks with Soap & Towel Dispensers

- 10"W x 14"D x 6" deep bowl
- Built-in soap & towel dispenser
- 10-406L faucet with 1/4 turn ceramic valves (1.8 GPM)
- 1-1/2" drain

Model	Width	Depth	Wgt.
18-12DST	12"	23-1/2"	50
18-18ST	18"	18-1/2"	46

## Drop-In Counter Top Installed Hand Sink

- Bowl: 10"W x 14"D x 5"H Deep
- Counter top installed
- Front access Towel Dispenser
- Deck Mounted Soap Dispenser
- Faucet included
- Two models available: one with 4"H backsplash and one with 8"H backsplash



Model	Backsplash	Bowl
HS-74	4"H	5" Deep
HS-78	8"H	5" Deep

## Sink Strainers



### Dish Table Sink Strainer

- Stainless Steel Pre-Rinse Drain Basket
- 18 gauge Stainless Steel
- Fits 20" x 20" Bowl
- 4" Deep

Model  
30-150



### 10" x 14" Stainless Steel Sink Strainer

- 5" deep stainless steel
- Fits all 10" x 14" sink bowls
- Used on Bar Sinks, Dump Sinks, and 18" Blender Stations

Model  
30-152



### 10" x 14" Plastic Sink Strainer

- 6" deep durable clear plastic
- Fits all 10" x 14" sink bowls
- Used on all Bar Sinks, Dump Sinks, and Blender Stations

Model  
30-160



### 10" x 12" Stainless Steel Sink Strainer

- 5" deep stainless steel
- Fits all 10" x 12" sink bowls
- Used on Bar Sinks, Dump Sinks, and Blender Stations

Model  
30-153

## Floor Strainers



### 8-1/2" Plastic Kitchen Floor Drain Strainer

- Fits in kitchen floor drain
- 8-1/2" x 8-1/2" x 3" overall
- Drains from bottom and sides
- Prevents drain blockage
- Easy to remove and clean

Model  
30-148



### 11-3/4" Plastic Floor Drain Strainer

- Fits into standard floor drain
- 8" x 8" bowl
- 11-3/4" x 11-3/4" overall
- Also fits bar sink bowls
- Easy to remove and clean

Model  
30-141



### 6-1/2" Plastic Floor Drain Strainer

- Fits into floor drain
- 6-1/2" x 6-1/2" x 3" overall
- Prevents drain blockage
- Easy to remove and clean

Model  
30-145



### 8-1/2" Plastic Floor Drain Strainer

- Fits in kitchen floor drain
- 8-1/2" x 8-1/2" x 2" overall
- Prevents drain blockage
- Easy to remove and clean

Model  
30-147

# Gas Connectors

**Krowne Gas Connectors** have built a solid reputation for their durability and design. Any gas connector you purchase from Krowne comes with a lifetime guarantee. We 100% ensure our product's quality and longevity.

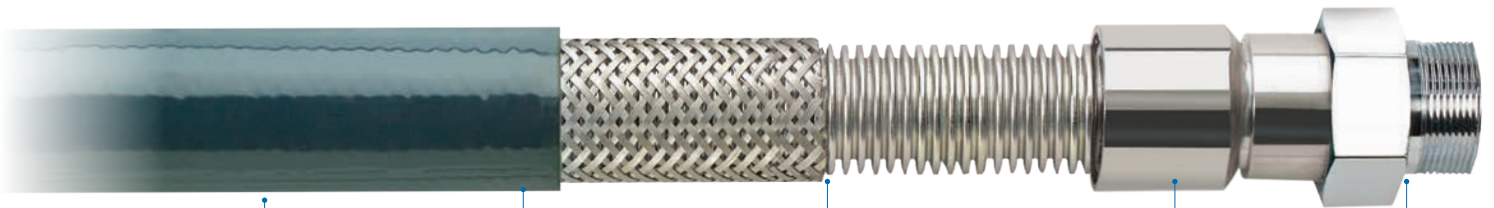

**PVC Protective Coating**  
With antimicrobial agent for easy cleaning.

**Radial Wrap**  
Heavy duty stainless steel radial wrap prevents hose from stretching.

**Corrugated Tubing**  
Stainless steel corrugated tubing built to be flexible for ease of installation.

**Welded Construction**  
360° heavy duty welds on both ends increases durability.

**Rotational Ends**  
360° rotational ends provide versatility and ease during installation.

## Gas Connector Parts & Accessories



**One-Handed Quick Disconnect w/ 10-Point 360° Locking System**  
Quickly and easily disconnect hose to move equipment for cleaning and maintenance.



**SwivelKing™**  
Durable stainless steel construction with dual 360° rotation significantly reduces stress and extends life of hose.



**Restraining Kit**  
Comes pre-cut 12" shorter than overall length of hose to prevent hose from being pulled too far. Easily disconnects for cleaning and maintenance.



**Caster Positioning Chocks**  
Creates a home position for movable kitchen equipment. Stainless steel construction eliminates cracking commonly seen with plastic caster positioning sets.



**Full Port Ball Valve**  
Required by code to allow for manual gas shutoff within 5 ft. of appliance.



**Black Malleable Street 90° Elbows**  
Allows for versatility in tight conditions during installation.



## Complete Kit

**Includes:**

- Gas Connector
- Quick Disconnect
- Shut-off Valve
- Restraining Cable Kit
- (2) 90° Elbows

**Case Quantities**

Select Complete Kits are available in case quantities of 6.



Model	Interior Size	Length	BTU/hr*	Case Qty.
M5024K	1/2"	24"	87K	-
M5036K	1/2"	36"	77K	6
M5048K	1/2"	48"	68K	-
M5060K	1/2"	60"	60K	6
M5072K	1/2"	72"	55K	-
M7524K	3/4"	24"	232K	6
M7536K	3/4"	36"	218K	6
M7548K	3/4"	48"	180K	6
M7560K	3/4"	60"	158K	6
M7572K	3/4"	72"	139K	6
M10024K	1"	24"	414K	-
M10036K	1"	36"	379K	6
M10048K	1"	48"	334K	6
M10060K	1"	60"	294K	6
M10072K	1"	72"	279K	-
M12524K	1-1/4"	24"	699K	-
M12536K	1-1/4"	36"	615K	-
M12548K	1-1/4"	48"	541K	-
M12560K	1-1/4"	60"	476K	-
M12572K	1-1/4"	72"	419K	-

\*Minimum Flow Capacity  
(0.64 Sp. Gr., 1000 BTU/ft3 Natural Gas at 0.5" wc pressure drop)

## Complete Kit with One SwivelKing™

**Includes:**

- Gas Connector
- Quick Disconnect
- Shut-off Valve
- Restraining Cable Kit
- (2) 90° Elbows
- SwivelKing™



Model	Interior Size	Length	BTU/hr*
M5024K9	1/2"	24"	87K
M5036K9	1/2"	36"	77K
M5048K9	1/2"	48"	68K
M5060K9	1/2"	60"	60K
M5072K9	1/2"	72"	55K
M7524K9	3/4"	24"	232K
M7536K9	3/4"	36"	218K
M7548K9	3/4"	48"	180K
M7560K9	3/4"	60"	158K
M7572K9	3/4"	72"	139K
M10024K9	1"	24"	414K
M10036K9	1"	36"	379K
M10048K9	1"	48"	334K
M10060K9	1"	60"	294K
M10072K9	1"	72"	279K
M12524K9	1-1/4"	24"	699K
M12536K9	1-1/4"	36"	615K
M12548K9	1-1/4"	48"	541K
M12560K9	1-1/4"	60"	476K
M12572K9	1-1/4"	72"	419K

\*Minimum Flow Capacity  
(0.64 Sp. Gr., 1000 BTU/ft3 Natural Gas at 0.5" wc pressure drop)

## Complete Kit with Two SwivelKings™

**Includes:**

- Gas Connector
- Quick Disconnect
- Shut-off Valve
- Restraining Cable Kit
- (2) 90° Elbows
- (2) SwivelKings™



Model	Interior Size	Length	BTU/hr*
M5024K10	1/2"	24"	87K
M5036K10	1/2"	36"	77K
M5048K10	1/2"	48"	68K
M5060K10	1/2"	60"	60K
M5072K10	1/2"	72"	55K
M7524K10	3/4"	24"	232K
M7536K10	3/4"	36"	218K
M7548K10	3/4"	48"	180K
M7560K10	3/4"	60"	158K
M7572K10	3/4"	72"	139K
M10024K10	1"	24"	414K
M10036K10	1"	36"	379K
M10048K10	1"	48"	334K
M10060K10	1"	60"	294K
M10072K10	1"	72"	279K
M12524K10	1-1/4"	24"	699K
M12536K10	1-1/4"	36"	615K
M12548K10	1-1/4"	48"	541K
M12560K10	1-1/4"	60"	476K
M12572K10	1-1/4"	72"	419K

\*Minimum Flow Capacity  
(0.64 Sp. Gr., 1000 BTU/ft<sup>3</sup> Natural Gas at 0.5" wc pressure drop)

## Complete Kit with Two SwivelKings™ & Caster Positioning Chocks

**Includes:**

- Gas Connector
- Quick Disconnect
- Shut-off Valve
- Restraining Cable Kit
- (2) 90° Elbows
- (2) SwivelKings™
- Caster Positioning Chocks



Model	Interior Size	Length	BTU/hr*
M5024K12	1/2"	24"	87K
M5036K12	1/2"	36"	77K
M5048K12	1/2"	48"	68K
M5060K12	1/2"	60"	60K
M5072K12	1/2"	72"	55K
M7524K12	3/4"	24"	232K
M7536K12	3/4"	36"	218K
M7548K12	3/4"	48"	180K
M7560K12	3/4"	60"	158K
M7572K12	3/4"	72"	139K
M10024K12	1"	24"	414K
M10036K12	1"	36"	379K
M10048K12	1"	48"	334K
M10060K12	1"	60"	294K
M10072K12	1"	72"	279K
M12524K12	1-1/4"	24"	699K
M12536K12	1-1/4"	36"	615K
M12548K12	1-1/4"	48"	541K
M12560K12	1-1/4"	60"	476K
M12572K12	1-1/4"	72"	419K

\*Minimum Flow Capacity  
(0.64 Sp. Gr., 1000 BTU/ft<sup>3</sup> Natural Gas at 0.5" wc pressure drop)

## Gas Connector with Quick Disconnect & Restraining Cable Kit

**Includes:**

- Gas Connector
- Quick Disconnect
- Restraining Cable Kit



Model	Interior Size	Length	BTU/hr*
M5024K2	1/2"	24"	87K
M5036K2	1/2"	36"	77K
M5048K2	1/2"	48"	68K
M5060K2	1/2"	60"	60K
M5072K2	1/2"	72"	55K
M7524K2	3/4"	24"	232K
M7536K2	3/4"	36"	218K
M7548K2	3/4"	48"	180K
M7560K2	3/4"	60"	158K
M7572K2	3/4"	72"	139K
M10024K2	1"	24"	414K
M10036K2	1"	36"	379K
M10048K2	1"	48"	334K
M10060K2	1"	60"	294K
M10072K2	1"	72"	279K
M12524K2	1-1/4"	24"	699K
M12536K2	1-1/4"	36"	615K
M12548K2	1-1/4"	48"	541K
M12560K2	1-1/4"	60"	476K
M12572K2	1-1/4"	72"	419K

\*Minimum Flow Capacity  
(0.64 Sp. Gr., 1000 BTU/ft3 Natural Gas at 0.5" wc pressure drop)

## Gas Connector with Quick Disconnect

**Includes:**

- Gas Connector
- Quick Disconnect



Model	Interior Size	Length	BTU/hr*
M5024K5	1/2"	24"	87K
M5036K5	1/2"	36"	77K
M5048K5	1/2"	48"	68K
M5060K5	1/2"	60"	60K
M5072K5	1/2"	72"	55K
M7524K5	3/4"	24"	232K
M7536K5	3/4"	36"	218K
M7548K5	3/4"	48"	180K
M7560K5	3/4"	60"	158K
M7572K5	3/4"	72"	139K
M10024K5	1"	24"	414K
M10036K5	1"	36"	379K
M10048K5	1"	48"	334K
M10060K5	1"	60"	294K
M10072K5	1"	72"	279K
M12524K5	1-1/4"	24"	699K
M12536K5	1-1/4"	36"	615K
M12548K5	1-1/4"	48"	541K
M12560K5	1-1/4"	60"	476K
M12572K5	1-1/4"	72"	419K

\*Minimum Flow Capacity  
(0.64 Sp. Gr., 1000 BTU/ft3 Natural Gas at 0.5" wc pressure drop)

## Complete Kit For Canada

**Includes:**

- Gas Connector
- Quick Disconnect
- Shut-off Valve
- Restraining Cable Kit
- (2) 90° Elbows with Nipples

Case Quantity: 6



Model	Interior Size	Length	BTU/hr*
C5024K	1/2"	24"	87K
C5036K	1/2"	36"	77K
C5048K	1/2"	48"	68K
C5060K	1/2"	60"	60K
C5072K	1/2"	72"	55K
C7524K	3/4"	24"	232K
C7536K	3/4"	36"	218K
C7548K	3/4"	48"	180K
C7560K	3/4"	60"	158K
C7572K	3/4"	72"	139K
C10024K	1"	24"	414K
C10036K	1"	36"	379K
C10048K	1"	48"	334K
C10060K	1"	60"	294K
C10072K	1"	72"	279K
C12524K	1-1/4"	24"	699K
C12536K	1-1/4"	36"	615K
C12548K	1-1/4"	48"	541K
C12560K	1-1/4"	60"	476K
C12572K	1-1/4"	72"	419K

\*Minimum Flow Capacity  
(0.64 Sp. Gr., 1000 BTU/ft<sup>3</sup> Natural Gas at 0.5" wc pressure drop)

## Gas Connector Hose Only

**Includes:**

- Gas Connector



Model	Interior Size	Length	BTU/hr*
M5024	1/2"	24"	87K
M5036	1/2"	36"	77K
M5048	1/2"	48"	68K
M5060	1/2"	60"	60K
M5072	1/2"	72"	55K
M7524	3/4"	24"	232K
M7536	3/4"	36"	218K
M7548	3/4"	48"	180K
M7560	3/4"	60"	158K
M7572	3/4"	72"	139K
M10024	1"	24"	414K
M10036	1"	36"	379K
M10048	1"	48"	334K
M10060	1"	60"	294K
M10072	1"	72"	279K
M12524	1-1/4"	24"	699K
M12536	1-1/4"	36"	615K
M12548	1-1/4"	48"	541K
M12560	1-1/4"	60"	476K
M12572	1-1/4"	72"	419K

\*Minimum Flow Capacity  
(0.64 Sp. Gr., 1000 BTU/ft<sup>3</sup> Natural Gas at 0.5" wc pressure drop)

# Gas Connector Parts & Accessories



## SwivelKing™ Connector

- Allows gas hose to swivel in tight areas
- Reduces stress on the hose from bending
- Full gas flow with no restriction
- 360° full rotation
- Female NPT x Male NPT

Model	Fits
<b>SW50</b>	Fits 1/2" Gas Connectors
<b>SW75</b>	Fits 3/4" Gas Connectors
<b>SW100</b>	Fits 1" Gas Connectors
<b>SW125</b>	Fits 1-1/4" Gas Connectors



SwivelKing installed on a gas connector.



QD75

## Quick Disconnect

- Allow for easy disconnect to move equipment for maintenance and cleaning

Model	Size
<b>QD50</b>	Fits 1/2" Connectors
<b>QD75</b>	Fits 3/4" Connectors
<b>QD100</b>	Fits 1" Connectors
<b>QD125</b>	Fits 1-1/4" Connectors



R36

## Restraining Cable Kit

- Restraining kit will be 12" shorter than hose length
- Mounting hardware included

Model	Size
<b>R24</b>	Used with 24" Connectors
<b>R36</b>	Used with 36" Connectors
<b>R48</b>	Used with 48" Connectors
<b>R60</b>	Used with 60" Connectors
<b>R72</b>	Used with 72" Connectors



G75

## Full Port Ball Valve

- Required by code to allow manual gas shutoff within 5 ft. of appliance

Model	Size
<b>G50</b>	1/2" Female NPT Ball Valve
<b>G75</b>	3/4" Female NPT Ball Valve
<b>G100</b>	1" Female NPT Ball Valve
<b>G125</b>	1-1/4" Female NPT Ball Valve



E75

## Black Malleable Street 90° Elbows

Model	Size
<b>E50</b>	1/2" Female x Male NPT
<b>E75</b>	3/4" Female x Male NPT
<b>E100</b>	1" Female x Male NPT
<b>E125</b>	1-1/4" Female x Male NPT



C75

## Black Malleable 90° Elbows with Nipples

Model	Size
<b>C50</b>	(2) 1/2" Elbows, (2) 1/2" Nipples
<b>C75</b>	(2) 3/4" Elbows, (2) 3/4" Nipples
<b>C100</b>	(2) 1" Elbows, (2) 1" Nipples
<b>C125</b>	(2) 1-1/4" Elbows, (2) 1-1/4" Nipples



RB7550

## Black Malleable Reducing Bushing

- Converts gas equipment w/ 1/2" inlet to use 3/4" gas connector for higher BTU flow
- 3/4" Male x 1/2" Female NPT

Model	Size
<b>RB7550</b>	3/4" x 1/2" Bushing

# Gas Connector Parts & Accessories



## Rear Caster Positioning Chocks

- Creates a home position for all movable kitchen equipment
- Ensures kitchen equipment is returned back to the proper location in relation to fire suppression and ventilation systems after removal for cleaning and maintenance
- Can be used with all caster-mounted equipment
- Fits all caster sizes
- Includes (2) rear chocks and mounting hardware
- Meets NFPA Codes 17A (5.64) & 96 (12.1.3) related to fire suppression systems
- Case quantity: 12 per



Rear Caster Chock creates a home position for caster-mounted kitchen equipment.

Model	Description	Case Qty.
<b>28-200</b>	Rear Caster Positioning Chocks	<b>12</b>



## Front Caster Positioning Chocks

**New**

- Requires our 28-200 Rear Caster Chocks, cannot be used independently
- Creates a home position for all movable kitchen equipment
- Ensures kitchen equipment is returned back to the proper location in relation to fire suppression and ventilation systems after removal for cleaning and maintenance
- Can be used with all caster-mounted equipment
- Fits all caster sizes
- Includes (2) front chocks and mounting hardware



Designed to work with our 28-200 Rear Caster Chocks.

Model	Description
<b>28-201</b>	Front Caster Positioning Chocks

## Gas Appliance Regulators

- Used on Foodservice kitchen equipment
- High strength aluminum casting
- RL50 & RL75 are set @ 10.0" W.C. with 5.0-12.0 spring installed
- RG50 & RG75 are set @ 3.5" W.C. with 3.0-6.0 spring installed



Model	Size
<b>RL50</b>	1/2" NPT for Liquid Propane
<b>RL75</b>	3/4" NPT for Liquid Propane
<b>RG50</b>	1/2" NPT for Natural Gas
<b>RG75</b>	3/4" NPT for Natural Gas

**New**

## Stationary Gas Connector

- Use for Stationary Commercial Gas cooking equipment
- Stainless Steel with PVC Antimicrobial Coating



Model	Interior Size	Length	BTU/hr*
<b>S5036</b>	1/2"	36"	120K
<b>S5048</b>	1/2"	48"	106K
<b>S7536</b>	3/4"	36"	256K
<b>S7548</b>	3/4"	48"	225K

\*Flow Rating  
0.64 Sp. Gr. at 0.5" wc pressure drop



# Specialty Products

Krowne offers a wide range of **Specialty Products** to help better serve the foodservice market's unique needs. We have a large inventory of Wok Faucets, Pot Fillers, Utility Sprays and Equipment Casters in stock and ready to ship same day.

# Grease Filters

All Krowne Grease Filters are UL listed (UL 1046 & ULC-S649) and are intended to be used with restaurant-type cooking equipment installed in accordance with ANSI/NFPA 96, "Ventilation Control and Fire Protection of Commercial Cooking Operations," the "International Mechanical Code," "International Fire Code," ANSI/NFPA 1, "Fire Code," or the "Uniform Mechanical Code."

## Royal Series Grease Filters

- Rounded Baffles are easier to clean, stronger, and allow for more efficient air flow
- Heavy Duty gauge stainless steel
- All filters are 2" deep
- Dishwasher safe
- Built-in handles for easy install and removal
- Fully interchangeable with existing filters

Model	Construction	Size
<b>RS1616</b>	Stainless Steel	16"H x 16"W
<b>RS1620</b>	Stainless Steel	16"H x 20"W
<b>RS1625</b>	Stainless Steel	16"H x 25"W
<b>RS2020</b>	Stainless Steel	20"H x 20"W
<b>RS2025</b>	Stainless Steel	20"H x 25"W
<b>RS2520</b>	Stainless Steel	25"H x 20"W



- NOTE:**
- Must order in complete cases (multiples of six)
  - Cannot mix and match sizes

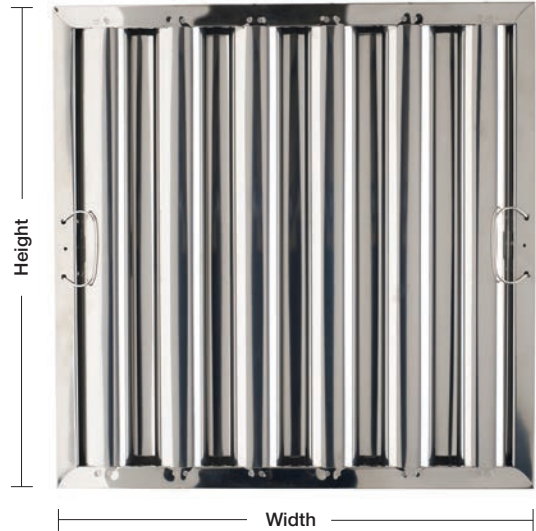

## Silver Series Grease Filters

- All filters are 2" deep
- Built-in handles for easy install and removal
- Fully interchangeable with existing filters

- NOTE:**
- Must order in complete cases (multiples of six)
  - Cannot mix and match sizes

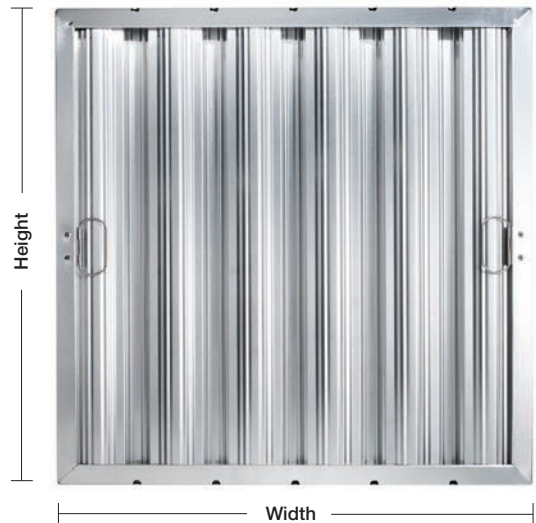

Model	Construction	Size
<b>A1616</b>	Aluminum	16"H x 16"W
<b>A1620</b>	Aluminum	16"H x 20"W
<b>A1625</b>	Aluminum	16"H x 25"W
<b>A2016</b>	Aluminum	20"H x 16"W
<b>A2020</b>	Aluminum	20"H x 20"W
<b>A2025</b>	Aluminum	20"H x 25"W
<b>A2520</b>	Aluminum	25"H x 20"W

Model	Construction	Size
<b>G1616</b>	Galvanized Steel	16"H x 16"W
<b>G1620</b>	Galvanized Steel	16"H x 20"W
<b>G1625</b>	Galvanized Steel	16"H x 25"W
<b>G2016</b>	Galvanized Steel	20"H x 16"W
<b>G2020</b>	Galvanized Steel	20"H x 20"W
<b>G2025</b>	Galvanized Steel	20"H x 25"W
<b>G2520</b>	Galvanized Steel	25"H x 20"W

Model	Construction	Size
<b>S1020</b>	Stainless Steel	10"H x 20"W
<b>S1616</b>	Stainless Steel	16"H x 16"W
<b>S1620</b>	Stainless Steel	16"H x 20"W
<b>S1625</b>	Stainless Steel	16"H x 25"W
<b>S2016</b>	Stainless Steel	20"H x 16"W
<b>S2020</b>	Stainless Steel	20"H x 20"W
<b>S2025</b>	Stainless Steel	20"H x 25"W
<b>S2520</b>	Stainless Steel	25"H x 20"W



## HydroSift™ Water Filters

Krowne's HydroSift™ Water Filters are the premier foodservice water filtration solution. Our bacteriostatic filters diminishes limescale, reduces chlorine/chloramine, and eliminates bad tastes and odor. The result is a clean and safe water ready to serve to your customers.



KR-HS3-KIT shown fully assembled.



### Triple Filter Assembly Kit

- Includes triple filter assembly with mounting bracket, (2) cartridge filters, (1) sediment cartridge filter, (3) male to male nipple fittings, male to female ball valve, reducing bushing, female tee fitting, pressure gauge and filter wrench
- 3/4" NPT water in and out connections
- 8.0 GPM max flow rate
- 20,000 gallon capacity
- 20-100 PSI non-shock working pressure (1.38-6.89 bar)
- 35° - 160°F operating temperature

Model  
**KR-HS3-KIT**



### Twin Filter Assembly Kit

- Includes twin filter assembly with mounting bracket, (1) cartridge filter, (1) sediment cartridge filter, (2) male to male nipple fittings, male to female ball valve, reducing bushing, female tee fitting, pressure gauge and filter wrench
- 3/4" NPT water in and out connections
- 2.5 GPM max flow rate
- 15,000 gallon capacity
- 20-100 PSI non-shock working pressure (1.38-6.89 bar)
- 35° - 160°F operating temperature

Model  
**KR-HS2-KIT**



### Single Filter Assembly Kit

- Includes single filter assembly with mounting bracket, (1) cartridge filter, (1) male to male nipple fitting, male to female ball valve, reducing bushing, female tee fitting, pressure gauge and filter wrench
- 3/4" NPT water in and out connections
- 2.5 GPM max flow rate
- 10,000 gallon capacity
- 20-100 PSI non-shock working pressure (1.38-6.89 bar)
- 35° - 160°F operating temperature

Model  
**KR-HS1-KIT**

### Single Assembly with Filter Cartridge

- Includes single filter assembly with bracket, (1) cartridge filter
- 3/4" NPT water in and out connections
- 2.5 GPM max flow rate
- 10,000 gallon capacity
- 20-100 PSI non-shock working pressure (1.38-6.89 bar)
- 35° - 160°F operating temp

Model  
**KR-HSA**



### Filter Cartridge

- Bacteriostatic filter
- Diminishes limescale, reduces chlorine/chloramine, and eliminates bad taste & odor
- For use in Single, Twin and Triple Filter Assemblies

Model  
**KR-FC**



### Sediment Filter Cartridge

- Reduces sediment and silt
- For use in Twin and Triple Filter Assemblies

Model  
**KR-SF**



## Wok Faucets



### Heavy Duty 3/8" Male Inlet Wok Range Faucet with 13-3/4" Spout

- 3/8" NPT male inlet
- Automatically turns on when spout is swung over wok

#### Faucet

Model	Case Qty.
16-220L	20

#### Replacement Parts

Model	Description
21-640L	O-Ring Repair Kit
21-643L	Replacement Aerator



### 3/8" Wok Range Faucet

- 3/8" NPT male inlet
- Automatically turns on when spout is swung over wok

#### Faucets

Model	Spout Size	Case Qty.
13-222L	12" Swing	20
13-223L	14" Swing	20
13-225L	17" Swing	20

#### Replacement Parts

Model	Description
21-561L	Repair Kit
21-565L	Replacement Aerator



### Heavy Duty Wall Mount Extended Wok Range Faucet

- Heavy Duty
- 10" Swing Spout
- 8 1/4" extension from wall
- 1/2" NPT male inlet
- 1/4 turn ceramic cartridge valve
- Replacement Parts Available

#### Faucet

Model	Spout Size
16-240L	10" Swing

#### Replacement Parts

Model	Description
21-620L	Royal Series Valve Repair Kit with Handle
22-611L	Replacement Aerator



### Wall Mount Extended Wok Range Faucets

- Commercial Series
- 8 1/4" Extension from Wall
- 1/2" NPT male inlet
- Replacement Parts Available

#### Faucets

Model	Spout Size
12-170L	10" Swing
12-171L	12" Swing

#### Replacement Parts

Model	Description
21-600L	Silver Series Valve Repair Kit with Handle
22-611L	Replacement Aerator

## Wok Faucet Replacement Parts



### Royal Series O-Ring Repair Kit

- Fits Royal Series Wok Faucets

Model  
**21-640L**



### Royal Series Valve for Extended Range Faucets

- Fits Royal Series Wok Faucets
- Includes Wrist Blade handle

Model  
**21-620L**



### Replacement Aerator

- Fits Royal Series Wok Faucets

Model  
**21-643L**



### Silver Series Wok Faucet Repair Kit

- Fits Silver Series Wok Faucets
- Includes Green T, Spring, 2 O-Rings, and Brass Plunger

Model  
**21-561L**



### Silver Series Valve for Extended Range Faucets

- Fits Silver Series Wok Faucets

Model  
**21-600L**

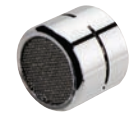

### Replacement Aerators

- Fits Royal Series Extended Wok Faucets
- Fits Silver Series Wok Faucets

Model	Flow Rate
<b>21-565L</b>	1.95 GPM
<b>22-611L</b>	2.20 GPM

## Specialty Utility Spray

### Utility Spray with Add-On Faucet

- Wall Mount
- 8" Centers
- 12" Spout
- 96" Hose
- Built-in Check Valves
- Wall Mounting kit
- 1/4 turn ceramic cartridge valves

Model  
**19-112L**



### REPLACEMENT PARTS & ACCESSORIES

### Angled Pre-Rinse Spray Head

Model  
**21-131L**



### 96" Hose with Grip

Model  
**21-136L**



# Utility Sprays

## 8" Center Wall Mount Utility Spray

- 1/2" NPT female inlets on 8" adjustable centers
- 72" long Stainless Steel flexible hose
- Plastic coated wall hook with chrome plated base
- Vacuum breaker
- Built-in check valves
- Mounting kit included



Model  
**19-108L**

## Single Wall Mount Utility Spray

- 1/2" NPT female inlet
- 72" long Stainless Steel flexible hose
- Plastic coated wall hook with chrome plated base
- Vacuum breaker
- Built-in check valves
- Mounting kit included



Model  
**19-101L**

## Deck Mount Utility Spray

- 1-1/8" OD x 2-1/2" shank
- Fits in 1 1/4" Hole
- 72" long Stainless Steel flexible hose
- Plastic coated wall hook with chrome plated base
- Vacuum breaker
- Built-in check valves
- Mounting kit included



Model  
**19-201L**

## 4" Center Deck Mount Utility Spray

- 1/2" NPT female inlets on 4" adjustable centers
- 72" long Stainless Steel flexible hose
- Plastic coated wall hook with chrome plated base
- Vacuum breaker
- Built-in check valves
- Mounting kit included



Model  
**19-204L**

## 8" Center Deck Mount Utility Spray

- 1/2" NPT male inlets on 8" adjustable centers
- 72" long Stainless Steel flexible hose
- Plastic coated wall hook with chrome plated base
- Vacuum breaker
- Built-in check valves
- Mounting kit included



Model  
**19-208L**

## Single Deck Mount Utility Spray

- 1/2" NPT male inlets
- 72" long Stainless Steel flexible hose
- Plastic coated wall hook with chrome plated base
- Vacuum breaker
- Built-in check valve
- Mounting kit included



Model  
**19-203L**

### REPLACEMENT PARTS & ACCESSORIES

#### Angled Pre-Rinse Spray Head

- Interchangeable with most brands
- Reinforced spray head
- Full repair kits available



Model  
**21-131L**

#### 72" Hose with Grip

- 72"L stainless steel flexible hose



Model  
**21-135L**

#### Wall Hook

- Rubber coated hook
- Mounts to wall



Model  
**21-144**

## Pot Fillers

### 8" Center Wall Mount Pot Filler

- 1/2" NPT female inlets on 8" adjustable centers
- 72" long Stainless Steel flexible hose
- Plastic coated wall hook with chrome plated base
- Vacuum breaker
- Built-in check valves
- Mounting kit included



Model  
**20-108L**

### Most Popular

### Single Wall Mount Pot Filler

- 1/2" NPT female inlet
- 72" long Stainless Steel flexible hose
- Plastic coated wall hook with chrome plated base
- Vacuum breaker
- Built-in check valves
- Mounting kit included



Model  
**20-101L**

### Deck Mount Pot Filler

- 1-1/8" OD x 2-1/2" shank
- Fits in 1-1/4" Hole
- 72" long Stainless Steel flexible hose
- Plastic coated wall hook with chrome plated base
- Vacuum breaker
- Built-in check valves
- Mounting kit included



Model  
**20-201L**

### 4" Center Deck Mount Pot Filler

- 1/2" NPT male inlets on 4" adjustable centers
- 72" long Stainless Steel flexible hose
- Plastic coated wall hook with chrome plated base
- Vacuum breaker
- Built-in check valves
- Mounting kit included



Model  
**20-204L**

### 8" Center Deck Mount Pot Filler

- 1/2" NPT female inlets on 8" adjustable centers
- 72" long Stainless Steel flexible hose
- Plastic coated wall hook with chrome plated base
- Vacuum breaker
- Built-in check valves
- Mounting kit included



Model  
**20-208L**

### Single Deck Mount Pot Filler

- 1/2" male inlet
- 72" long Stainless Steel flexible hose
- Plastic coated wall hook with chrome plated base
- Vacuum breaker
- Built-in check valves
- Mounting kit included



Model  
**20-203L**

### REPLACEMENT PARTS & ACCESSORIES

#### Pot Filler Spray Head

- Interchangeable with most brands
- Reinforced spray head
- Full repair kits available



Model  
**21-132L**

#### 72" Hose with Grip

- 72"L stainless steel flexible hose



Model  
**21-135L**

#### Wall Hook

- Rubber coated hook
- Mounts to wall



Model  
**21-144**

## Hose Reels

- Hose Reels extend the reach of a standard pre-rinse unit up to 35'
- Used for a variety of applications such as filling buckets without lifting them from the floor, rinsing down sinks, worktables and floors during clean up, as well as filling steam tables
- 35' hose (3/8" ID) capacity provides water source quickly and conveniently to all areas of the kitchen
- Equipped with a universal mounting bracket so that it can be mounted on the floor, wall, or ceiling; whichever place is more convenient for the environment
- Available in Stainless Steel or Gray Powder Coated finishes.
- Max Operating Pressure: 250 PSI
- Max Operating Temperature: 210°F
- Reel Inlet Connection; 3/8" (F) NPT



**Enclosed  
Stainless Steel  
Hose Reel**

Model  
**24-600**



**Open Gray  
Powder Coated  
Hose Reel**

Model  
**24-603**



**Most Popular**

**Open Stainless  
Steel Hose Reel**

Model  
**24-602**

### Open Stainless Steel Hose Reel with 8" Center Deck Mount Faucet on Stainless Steel Wall Plate

- Stainless Steel wall plate included for easy mounting
- 40" overall height, 26" overall width
- 8" raised deck mount faucet
- Replaces T&S Brass\* B-1436

Model  
**24-503**



### Enclosed Stainless Steel Hose Reel with 8" Center Faucet

- Designed to run water feed outside wall
- 57-1/2" overall height
- 8" center wall mount faucet
- Replaces T&S Brass\* B-1433

Model  
**24-502**



## Hose Reel Assembly Replacement Parts



Model	Description
<b>24-700</b>	35' Hose for Powder Coated Reels
<b>24-702</b>	35' Hose for Stainless Steel Reels
<b>21-126</b>	Angled Pre-Rinse Spray Head with Grip

# Test Strips

**New**

## Chlorine Test Strips

- Sanitizer Test Strips for Bleach-Based Solutions
- 100 strips per bottle
- Color-coded chart
- Test Range: 0-200 ppm



Model	Description
<b>S25-123</b>	1-Pack Loose
<b>P25-123</b>	2-Pack in Header

## QAC Test Strips

- Sanitizer Test Strips for QAC-Based Solutions
- 100 strips per bottle
- Color-coded chart
- Test Range: 0-500 ppm



Model	Description
<b>S25-124</b>	1-Pack Loose
<b>P25-124</b>	1-Pack in Header

## pH Test Strips

- Test acidity (pH) level in Sushi Rice, Salsa and Salad Dressing
- 50 strips per bottle
- Color-coded chart
- Test Range: 3.0-6.0 pH units



Model	Description
<b>S25-126</b>	1-Pack Loose
<b>P25-126</b>	1-Pack in Header

## High Range QAC Test Strips

- Used to test solutions that kill pathogenic organisms
- 50 strips per bottle
- Color-coded chart
- Test Range: 0-1500 ppm



Model	Description
<b>S25-127</b>	1-Pack Loose
<b>P25-127</b>	1-Pack in Header

# Wobble Wedges®

## 75-Pack Hard Wobble Wedges®

- Fix anything that wobbles
- Can be stacked
- Great for carpet
- Hard clear plastic wedges



<b>Model</b>	<b>29-160</b>
--------------	---------------

## 30-Pack Soft Wobble Wedges®

- Fix anything that wobbles
- Can be stacked
- Can be trimmed
- Great for hard surfaces
- Soft black plastic wedges



<b>Model</b>	<b>29-158</b>
--------------	---------------

# Cooking Accessories

## Chrome Oven Knobs

- Easy installation
- Built for durability



Model	Description
<b>25-200S</b>	1 Piece
<b>25-200</b>	Pack of 6

## Black Oven Knobs

- Easy installation
- Built for durability



Model	Description
<b>25-201S</b>	1 Piece

## Petrol-Gel Food Grade Grease

- Tasteless, odorless
- Non-toxic
- Rated from 15°F to 210°F
- 4 oz. tube



Model	Description
<b>S25-140</b>	4 oz. Loose Tube
<b>P25-140</b>	1 Pack in Header

# Refrigeration Accessories



## Exhaust Hood Vaporproof Light Fixture

- Meets Code 96 & NEC 410
- Designed for Commercial Cooking Hood
- Base 5-1/2"D, 3-1/2"H
- Height with globe 9-1/2"H
- Maximum 100W Bulb

Model	Description
<b>25-103</b>	Shatterproof Plastic Coated Glass Globe with Slanted Base (Replaces FMP® #253-1184)
<b>25-112</b>	Shatterproof Plastic Coated Globe with Wire Guard & Slanted Base (Replaces FMP® #253-1185)
<b>25-128</b>	Slanted Base for Exhaust Hood Vaporproof Light Fixture



## Refrigeration Light Fixture

- Die cast aluminum base
- Surface mount
- Maximum 100W Bulb

Model	Description
<b>25-113</b>	Shatterproof Plastic Coated Glass Globe with Wire Guard & Straight Base (Replaces FMP® #253-1230)
<b>25-118</b>	Shatterproof Plastic Coated Glass Globe with Straight Base (Replaces FMP® #253-1229)
<b>25-120</b>	Tempered Glass Globe with Wire Guard & Straight Base (Replaces FMP® #253-1231)
<b>25-125</b>	Tempered Glass Globe with Straight Base (Replaces FMP® #253-1228)
<b>25-129</b>	Straight Base for Refrigeration Light Fixture



## Replacement Globe

- Maximum 100W Bulb
- Rated to 392° F (200°C) for Glass Globes
- 9 pieces per case

Model	Description
<b>25-100</b>	Shatterproof Plastic Coated Globe 3-1/4"D x 6-3/4"H
<b>25-101</b>	Plastic Globe 3-1/4"D x 6-3/4"H
<b>25-102</b>	Tempered Glass Globe 3-1/4"D x 6-3/4"H



## Wire Guard for Light Fixtures

- Fits standard 3-1/4" diameter x 6-3/4" high globe
- Zinc plated
- Maximum 100W bulb
- Rated to 392°F (200°C)
- Replaces FMP® #253-1232

**Model**  
**25-104**



**30-317**      **30-318**



**P30-318**

## Stainless Steel Snap-In Shelf Support

- Tab on top
- 7/8" wide

Model	Description
<b>30-317</b>	Zinc Plated, 1 piece (Replaces FMP® #135-1240)
<b>30-318</b>	Stainless Steel, 1 piece (Replaces FMP® #135-1241)
<b>P30-318</b>	Stainless Steel (pack of 12 pieces)



## Coffee Urn Faucets

**New**

- Premium brass faucet body and bonnet with chrome finish
- Includes spring, stem and seat cup
- Three color-coded handle options available

Model	Description
<b>19-301</b>	Black for Coffee
<b>19-302</b>	Orange for Decaff
<b>19-303</b>	Red for Hot Water



## Fryer Accessories



30-325  
Shown on fryer

### Stainless Steel Fryer Splash Guards

- Fits most fryers
- Stainless Steel - 20.5" x 18"
- Used for preventing the travel of hot oil

Model	Description
30-324	Guard for 1/2" thick fryer walls
30-325	Guard for 1" thick fryer walls



### Fryer Cleaning Brush

- For temperatures up to 750°F
- Durable brass bristles
- Angled head for easy cleaning
- No need for oil to cool completely when cleaning

<b>Model</b>	<b>30-330</b>
--------------	---------------



### Fryer Clean Out Rod

- For cleaning clogged fryer drains
- 25" Long
- Stainless Steel
- Can be used on any fryer type

<b>Model</b>	<b>30-335</b>
--------------	---------------

## Food Grade Sprays

### Food Grade Grease



- Great for use on food contact equipment such as choppers, slicers, toasters, and conveyor chains
- Protects against oxidation and wear
- 10 oz.

Model	Case Qty.
30-200	6

### Food Grade Oil



- Great for use on mixers, conveyors, rollers, slides, paste, and sauce fillers
- Odorless, tasteless, non-toxic, safe on plastic
- 12 oz.

Model	Case Qty.
30-201	6

### Food Grade Silicone



- Great for use on refrigerator doors, drawer slides, and food racks
- High viscosity, safe on plastic, ultra pure, no chlorine
- 9.25 oz.

Model	Case Qty.
30-202	6

## Foodservice Accessories

### 3-Compartment Bottle Wells for Ice Bins

- Overall Flange size 16"L x 6-3/4"W
- Fits in any ice bin that is at least 14-1/4" front to back
- Built-in rail for sliding cover
- Raised floor to keep bottles dry



Model	Description
30-550	1 Bottle Well
30-502	2-Pack

### Super-Level® Self-Leveling Glide

- Automatically adjusts tables
- 1-1/8" base diameters
- 1/4" - 20 thread
- 25 to 140 lbs. load capacity per set of 4



<b>Model</b>	<b>29-162</b>
--------------	---------------

### Bullet Foot

- Plastic bullet foot for 1-5/8" diameter legs
- Fits all Krowne Ice Bins and Underbar Equipment
- Fits most kitchen sinks and worktables



Model	Description
29-108	Plastic Bullet Foot
29-101	Stainless Steel Bullet Foot

## Ice & Water Service Stations



WS-2

### Drop-In Water/Ice Station

- 27" x 20" x 12" overall
- Push-back glass filler included (8" high from deck to spout tip)
- 15-1/2" x 10-1/2" x 10" deep bin with 1" drain
- 1/2" IPS male water inlet
- Heavy Duty stainless steel wire grid

Model	Description
WS-2	Drop-In Water/Ice Station with 8" Glass Filler



WS-1

### Drop-In Water Station

- 12-1/2" x 12-1/2" overall
- Adjustable flow with continuous on position
- Push-back glass filler included (8" high from deck to spout tip)
- 1/2" IPS male water inlet
- 1/2" NPS nickel plated brass drain
- Heavy Duty stainless steel wire grid

Model	Description
WS-1	Drop-In Water Station with 8" Glass Filler



### Large Drop-In Ice Bin

- Overall: 27"W x 20"D x 12"H (15" Overall Depth with Cold Plate)
- Cutout: 25-1/4" x 18-1/4"
- 13-1/2" from left side to center drain
- Sliding cover included
- Fully insulated
- 10" deep liner

Model	Description
D2712	Large Drop-In Ice Bin
D2712-7	Large Drop-In Ice Bin with 7-Circuit Cold Plate
D2712-10	Large Drop-In Ice Bin with 10-Circuit Cold Plate
D2712DP	Large Drop-In Ice Bin Deep Style (15" deep liner)



### Medium Drop-In Ice Bin

- Overall: 20"W x 15"D x 12"H
- Cutout: 18-1/4" x 13-1/4"
- 10" from left side to center drain
- Sliding cover included
- Fully insulated
- 10" deep liner

Model	Description
D278	Medium Drop-In Ice Bin
D278-7	Medium Drop-In Ice Bin w/ 7-Circuit Cold Plate

# Ice & Water Service Station Accessories



**New**

## Deck Mount Pitcher Fillers & Glass Fillers

- Adjustable flow with continuous on position
- Push-back water activation
- Designated height is from deck to spout tip
- 1/2" NPS male inlet
- Fits in 7/8" hole

Model	Description
16-135L	8"H Glass Filler
16-137L	10"H Pitcher Filler
16-138L	12"H Pitcher Filler
16-139L	14"H Pitcher Filler
16-136L	Repair Kit for Glass/Pitcher Filler

## Front Mount Dipper Well

- Includes 16-151L faucet with shut-off
- 1" drain
- Stainless Steel
- 10" x 6" overall dimensions
- 1/2" NPT male inlet



Model  
**16-153L**

16-153L

## Drop-In Dipper Well & Faucet

- Fits 6-1/2" hole
- Short length (2-1/2")
- 1-1/2" drain
- Stainless Steel inner and outer can
- Chrome plated brass faucet
- 1/2" NPS inlet



16-149

Model	Description
16-149	Dipper Well & Faucet
16-150	Dipper Well Only
16-151L	Faucet Only

Replacement valve (Model 16-147) available for 16-151L.

**New**

## Dipper Well Faucet with Flow Restrictor

- 0.25 GPM
- 1/2" NPS Male inlet
- Chrome plated brass faucet
- Fits in 7/8" hole



Model  
**16-155L**

## Glass Rinser

- Stainless steel with heavy duty valve
- 4-1/2" disc diameter, fits in 7/8" hole
- 1/2" NPSM thread x 2-1/4" shank
- Includes adapter to fit 3/8" flexible water line
- Replaces all underbar manufacturers rinsers



16-144

Model	Description
16-144	Glass Rinser
16-146	Repair Kit



16-146

Repair Kit includes Replacement Rod, O-Ring & Spring

## Steam Table Faucet

- Fits in 3/4" hole deck mount
- 4-1/4" spout
- 1/2" NPS male inlet
- Ceramic cartridge valve



Model  
**16-152L**

For a replacement Ceramic Cartridge Valve with Handle, order model 21-332L

## In-line Pressure Regulator

- Fits all Glass Rinsers
- Lowers water pressure to prevent damage to valve
- Set at 15 - 20 PSI
- 1/2" Female NPT with 1/2" Male NPT x 3/8" Hose Barb Adapter



Model  
**16-165**

# Casters

**Krowne Casters** fit a wide variety of restaurant equipment from ranges and ovens to worktables and fryers. With brakes on all four casters, the equipment is guaranteed to stay put or easily roll out for cleaning when needed. From plate casters to threaded stem casters, you are sure to find the model you need for your application.





### Adjustable 6" - 7" Height Universal Plate Caster with Front Brake

- Fits most manufacturers
- 6" to 7" height adjustment
- 3-1/2" x 3-1/2" plate
- 3" grease resistant wheels
- Total lock front brake prevents swivel and locks wheel in place
- Weight capacity 220 lbs. per caster
- Temperature range of 14°F to 212°F
- 4 pieces per set
- Case quantity: 4 per case

Fits hole patterns:  
1-3/4" x 2-3/4" or  
2-3/4" x 2-3/4"

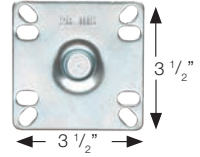

**Model**  
**28-114S**



### Heavy Duty Adjustable 6" - 7" Height Universal Plate Caster with Front Brake

- Fits most manufacturers
- 6" to 7" height adjustment
- 3-1/2" x 3-1/2" plate
- 3" grease resistant wheels
- Total lock front brake prevents swivel and locks wheel in place
- Heavy Duty weight capacity 500 lbs. per caster
- Temperature range of 4°F to 176°F
- 4 pieces per set
- Case quantity: 3 per case

Fits hole patterns:  
1-3/4" x 2-3/4" or  
2-3/4" x 2-3/4"

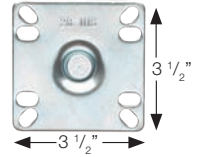

**Model**  
**28-135S**



### Adjustable 6" - 7" Height 2-3/8" x 3-5/8" Plate Caster with Front Brake

Fits Dean\* Fryers

- 6" to 7" height adjustment
- 2-3/8" x 3-5/8" plate
- 3" grease resistant wheels
- Total lock front brake prevents swivel and locks wheel in place
- Weight capacity 220 lbs. per caster
- Temperature range of 14°F to 212°F
- 4 pieces per set
- Case quantity: 4 per case

Fits hole pattern:  
1-3/4" x 3"

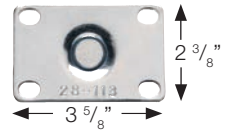

**Model**  
**28-160S**



### Adjustable 8-1/2" - 10-1/2" Height Plate Caster for Fryers

Fits Pitco\* Fryers

- 8-1/2" to 10-1/2" height adjustment
- 3-1/2" x 3-1/2" plate
- 3" grease resistant wheels
- Weight capacity 220 lbs. per caster
- Temperature range of 14°F to 212°F
- 4 pieces per set
- Case quantity: 4 per case

Fits hole patterns:  
1-3/4" x 2-3/4" or  
2-3/4" x 2-3/4"

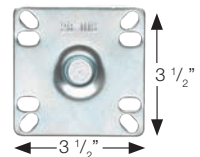

**Model**  
**28-117S**

\*This product is not manufactured or authorized by any other manufacturer. Registered Trade Name or Mark of the original manufacturer of the product which this part fits, is not owned, associated or to be confused with our company.



## Adjustable 6" - 7" Height 1/2"-13 Threaded Stem Caster with Front Brake

### Fits True\*

- 6" to 7" height adjustment
- 1/2"-13 x 1" threaded stem
- 3" grease resistant wheels
- Total lock front brake prevents swivel and locks wheel in place
- Weight capacity 200 lbs. per caster
- Temperature range of 14°F to 212°F
- 4 pieces per set
- Case quantity: 4 per case

**Model**  
**28-156S**



## Adjustable 6" - 7" Height 3/4"-10 Threaded Stem Caster with Front Brake

### Fits Garland\* & Southbend\* Ranges & Ovens

- 6" to 7" height adjustment
- 3/4"-10 x 1" threaded stem
- 3" grease resistant wheels
- Total lock front brake prevents swivel and locks wheel in place
- Weight capacity 200 lbs. per caster
- Temperature range of 14°F to 212°F
- 4 pieces per set
- Case quantity: 4 per case

**Model**  
**28-158S**



## 1-5/8" Stem Worktable Caster Used on Standard 1-5/8" Diameter Legs

- Fits standard 1-5/8" tubing
- Used on Worktables
- Grease resistant wheels with side brakes
- Weight capacity per caster - 28-125S: 220 lbs, 28-129S: 250 lbs.
- Raises height of equipment 1" higher than wheel size
- Temperature range of 14°F to 212°F
- 4 pieces per set
- 28-125S case quantity: 6 per case
- 28-129S case quantity: 4 per case

Model	Height	Wheel Size
<b>28-125S</b>	4" Overall	3" Wheels
<b>28-129S</b>	6" Overall	5" Wheels



## 1-1/2" Stem Worktable Caster Used on 1-1/2" Diameter Legs

- Fits 1-1/2" tubing
- Used on Worktables
- Grease resistant wheels with side brakes
- Weight capacity 220 lbs. per caster
- Raises height of equipment 1" higher than wheel size
- Temperature range of 14°F to 212°F
- 4 pieces per set
- 28-118S case quantity: 6 per case
- 28-124S case quantity: 4 per case

Model	Height	Wheel Size
<b>28-118S</b>	4" Overall	3" Wheels
<b>28-124S</b>	6" Overall	5" Wheels



### 2" Overall Ultra Low Profile Universal Plate Caster, 3-1/2" x 3-1/2"

- Fits most manufacturers
- 3-1/2" x 3-1/2" universal plate
- 1" wheels with front brakes
- Raises height of equipment 2"
- Weight capacity 200 lbs. per caster
- Temperature range of 4°F to 176°F
- 4 pieces per set
- Case quantity: 12 per case

**Fits hole patterns:**  
1-3/4" x 2-3/4" or  
2-3/4" x 2-3/4"

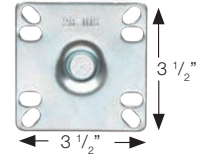

**Model**  
**28-109S**



### 3" Overall Low Profile Plate Caster, 3-1/2" x 3-1/2"

- Fits most manufacturers
- 3-1/2" x 3-1/2" universal plate
- 2" wheels with side brakes
- Raises height of equipment 3"
- Weight capacity 200 lbs. per caster
- Temperature range of 4°F to 176°F
- 4 pieces per set
- Case quantity: 10 per case

**Fits hole patterns:**  
1-3/4" x 2-3/4" or  
2-3/4" x 2-3/4"

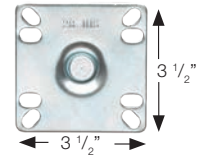

**Model**  
**28-110S**



### Universal Plate Casters, 3-1/2" x 3-1/2"

**Fits Pitco\* Fryers & Most Other Manufacturers**

- Fits most manufacturers
- 3-1/2" x 3-1/2" universal plate
- Grease resistant wheels with side brakes
- Raises height of equipment 1" higher than wheel size
- Weight capacity 250 lbs. per caster
- Temperature range of 14°F to 212°F
- 4 pieces per set
- Case quantity: 4 per case

**Fits hole patterns:**  
1-3/4" x 2-3/4" or  
2-3/4" x 2-3/4"

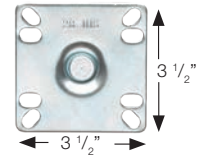

Model	Height	Wheel Size
<b>28-111S</b>	6" Overall	5" Wheels
<b>28-115S</b>	5" Overall	4" Wheels
<b>28-116S</b>	4" Overall	3" Wheels



### Universal Plate Caster, 4" x 4"

**3" or 5" Wheel**

- 4" x 4" universal plate
- Grease resistant wheels with side brakes
- Raises height of equipment 1" higher than wheel size
- Weight capacity per caster  
28-101S: 220 lbs.  
28-107S: 250 lbs.
- Temperature range of 14°F to 212°F
- 4 pieces per set
- Case quantity: 4 per case

**Fits hole patterns:**  
1-3/4" x 2-3/4" or  
2-3/4" x 2-3/4"

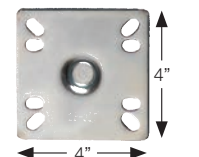

Model	Height	Wheel Size
<b>28-101S</b>	4" Overall	3" Wheels
<b>28-107S</b>	6" Overall	5" Wheels

\*This product is not manufactured or authorized by any other manufacturer. Registered Trade Name or Mark of the original manufacturer of the product which this part fits, is not owned, associated or to be confused with our company.



### 6" Overall Heavy Duty Universal Plate Caster, 3-1/2" x 3-1/2" with Front Brake

- Fits most manufacturers
- 3-1/2" x 3-1/2" universal plate
- 5" grease resistant wheels with front brakes
- Raises height of equipment 6"
- Heavy Duty weight capacity 500 lbs. per caster
- Temperature range of 14°F to 212°F
- 4 pieces per set
- Case quantity: 3 per case

Fits hole patterns:  
1-3/4" x 2-3/4" or  
2-3/4" x 2-3/4"

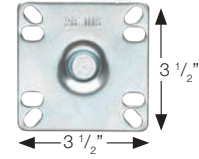

**Model**  
**28-260S**



### 6" Overall Heavy Duty Universal Plate Caster, 4" x 4"

- 4" x 4" universal plate
- 5" grease resistant wheels with side brakes
- Raises height of equipment 6"
- Heavy Duty weight capacity 500 lbs. per caster
- Temperature range of 14°F to 212°F
- 4 pieces per set
- Case quantity: 3 per case

Fits hole patterns:  
1-3/4" x 2-3/4" or  
2-3/4" x 2-3/4"

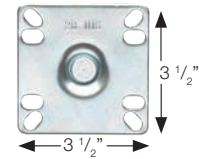

**Model**  
**28-120S**



### 6" Overall Plate Caster, 2-3/8" x 3-5/8"

- 2-3/8" x 3-5/8" plate
- 5" grease resistant wheels with side brakes
- Raises height of equipment 6"
- Weight capacity 250 lbs. per caster
- Temperature range of 14°F to 212°F
- 4 pieces per set
- Case quantity: 4 per case

Fits hole pattern:  
1-3/4" x 2-3/4"

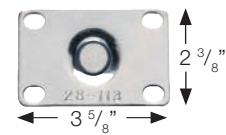

**Model**  
**28-113S**



### 6" Overall Universal Wire Shelving Caster

- Fits standard 1" diameter wire shelving posts
- (2) Allen screws fasten caster
- 5" grease resistant wheels with side brakes
- Raises height of equipment 6"
- Weight capacity 220 lbs. per caster
- Temperature range of 14°F to 212°F
- 4 pieces per set
- Case quantity: 4 per case



**Model**  
**28-151S**





## 6" Overall 1" Square Post Wire Shelving Caster

**Fits Amco\* Shelving**

- Fits 1" square posts
- (2) Allen screws fasten caster
- 5" grease resistant wheels with side brakes
- Raises height of equipment 6"
- Weight capacity 220 lbs. per caster
- Temperature range of 14°F to 212°F
- 4 pieces per set
- Case quantity: 4 per case

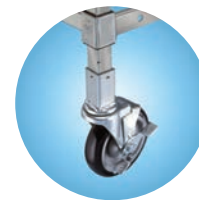

**Model**  
**28-172S**



## 6" Overall 1-1/4" Square Post Shelving Caster

**Fits Cambro\* Camshelving**

- Fits 1-1/4" square posts
- (2) Allen screws fasten caster
- 5" grease resistant wheels with side brakes
- Raises height of equipment 6"
- Weight capacity 220 lbs. per caster
- Temperature range of 14°F to 212°F
- 4 pieces per set
- Case quantity: 6 per case



**Model**  
**28-174S**



## Heavy Duty Adjustable Height Stem Caster for Single Deck Convection Oven

**Fits Vulcan\*, Hobart\* and Wolf\***

- 4" grease resistant wheels
- Raises height of equipment 5" - 6-1/4"
- Total lock front brake prevents swivel and locks wheel in place
- Heavy Duty weight capacity 350 lbs. per caster
- Temperature range of 14°F to 212°F
- 4 pieces per set
- Case quantity: 4 per case

**Model**  
**28-136S**



## 4" Overall M14 x 2.0 Metric Threaded Stem Caster

**Fits Atosa\* Refrigeration**

- M14 Stem Caster, 1" long
- 3" grease resistant wheels with side brakes
- Raises height of equipment 4"
- Fits imported refrigeration
- Weight capacity 220 lbs. per caster
- Temperature range of 14°F to 212°F
- Refrigeration units with 3 or more doors require 2 sets
- 4 pieces per set
- Case quantity: 4 per case

**Model**  
**28-164S**

\*This product is not manufactured or authorized by any other manufacturer. Registered Trade Name or Mark of the original manufacturer of the product which this part fits, is not owned, associated or to be confused with our company.



 Includes 16 bolts and 16 lock washers

### 2" Overall Ultra Low Profile 4" x 5" Plate Caster

#### Fits True\* Refrigeration

- 1" grease resistant wheels with front brakes
- Raises height of equipment 2"
- Weight capacity 200 lbs. per caster
- Refrigeration units with 3 or more doors require 2 sets
- Temperature range of 4°F to 176°F
- 4 pieces per set
- Mounting bolts included
- Case quantity: 10 per case

Fits hole pattern:

2-7/8" x 4"

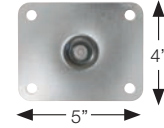

**Model**  
**28-168S**



 Includes 16 bolts and 16 lock washers

### 3" Overall Low Profile 4" x 5" Plate Caster

#### Fits True\* Refrigeration

- 2" grease resistant wheels with side brakes
- Raises height of equipment 3"
- Weight capacity 200 lbs. per caster
- Refrigeration units with 3 or more doors require 2 sets
- Temperature range of 4°F to 176°F
- 4 pieces per set
- Mounting bolts included
- Case quantity: 8 per case

Fits hole pattern:

2-7/8" x 4"



**Model**  
**28-169S**



 Includes 16 bolts and 16 lock washers

### 4" Overall 4" x 5" Plate Caster

#### Fits True\* Refrigeration

- 3" grease resistant wheels with side brakes
- Raises height of equipment 1" higher than wheel size
- Weight capacity 220 lbs. per caster
- Temperature range of 14°F to 212°F
- 4 pieces per set
- Mounting bolts included
- 28-170S case quantity: 4 per case

Fits hole pattern:

2-7/8" x 4"

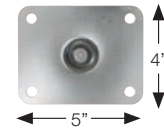

Model	Wheel Size
<b>28-170S</b>	3" Wheels (set of 4)
<b>28-193S</b>	3" Wheels (set of 6)



 Includes 16 bolts and 16 lock washers

### 5" Overall 4" x 5" Plate Caster

#### Fits True\* Refrigeration

- 4" grease resistant wheels with side brakes
- Raises height of equipment 1" higher than wheel size
- Weight capacity 220 lbs. per caster
- Temperature range of 14°F to 212°F
- 4 pieces per set
- Mounting bolts included
- 28-171S case quantity: 4 per case

Fits hole pattern:

2-7/8" x 4"

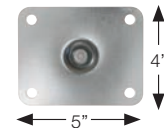

Model	Wheel Size
<b>28-171S</b>	4" Wheels (set of 4)
<b>28-194S</b>	4" Wheels (set of 6)



## 6" Overall 5/8" and 3/4" Threaded Stem Caster For Ranges and Ovens

- 1" long threaded stem caster
- 5" grease resistant wheels with side brakes
- Raises height of equipment 6"
- Weight capacity 220 lbs. per caster
- Temperature range of 14°F to 212°F
- 4 pieces per set
- Case quantity: 4 per case

Model	Wheel Size
<b>28-145S</b>	5" Wheel, 5/8" - 11 Thread
<b>28-146S</b>	5" Wheel, 3/4" - 10 Thread



## 6" Overall Heavy Duty Threaded Stem Caster For Griddles, Ranges and Ovens

- Threaded Stem
- 5" grease resistant wheels with side brakes
- Raises height of equipment 6"
- Heavy Duty weight capacity 500 lbs. per caster
- Temperature range of 14°F to 212°F
- 4 pieces per set
- 28-147S case quantity: 3 per case
- 28-185S case quantity: 4 per case

Model	Wheel Size
<b>28-147S</b>	3/4" - 10 Thread, Fits Garland & Southbend Range Ovens
<b>28-185S</b>	5/8" - 11 Thread, 5" Fits Jade



## 1/2" - 13 Threaded Stem Caster Threaded for Refrigeration

- 1" long threaded stem
- Grease resistant wheels with side brakes
- Raises height of equipment 1" higher than wheel size
- Temperature range: 4°F to 176°F
- 4 pieces per set
- 28-139S case quantity: 12 per case
- 28-140S case quantity: 6 per case
- 28-144S case quantity: 4 per case
- 28-141S case quantity: 4 per case

Model	Height	Wheel Size	Weight Capacity
<b>28-139S</b>	3" Overall	2" Wheel	200 lbs. per caster
<b>28-140S</b>	4" Overall	3" Wheel	220 lbs. per caster
<b>28-144S</b>	5" Overall	4" Wheel	220 lbs. per caster
<b>28-141S</b>	6" Overall	5" Wheel	220 lbs. per caster



## 6" Overall Heavy Duty Large Triangle Plate Caster

Fits Blodgett\* Convection Ovens

- 5-3/8" x 5-3/8" x 7-1/2" triangle plate caster
- 5" grease resistant wheels with side brakes
- Raises height of equipment 6"
- Heavy Duty weight capacity 500 lbs. per caster
- Temperature range of 14°F to 212°F
- 4 pieces per set
- Case quantity: 3 per case

Fits hole pattern:  
4-1/8" x 4-1/8" x 5-3/4"

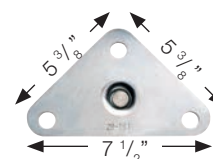

Model  
**28-161S**

\*This product is not manufactured or authorized by any other manufacturer. Registered Trade Name or Mark of the original manufacturer of the product which this part fits, is not owned, associated or to be confused with our company.



## 6" Overall Heavy Duty Convection Oven Triangle Plate Caster

Fits Garland \*

- 6" x 6" x 7-1/2" triangle plate caster
- 5" grease resistant wheels with side brakes
- Raises height of equipment 6"
- Heavy Duty weight capacity 500 lbs. per caster
- Temperature range of 14°F to 212°F
- 4 pieces per set
- Case quantity: 3 per case

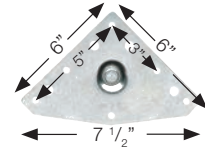

Model  
**28-166S**



## 7-1/4" Overall Extra Heavy Duty Large Plate Caster

Fits Vulcan\* & Hobart\* Double Stack Convection Ovens

- 4-1/2" x 4-1/8" plate
- 6" grease resistant wheels
- 2 wheels with side brakes, 2 wheels with no brakes
- Raises height of equipment 7-1/4"
- Extra Heavy Duty weight capacity 750 lbs. per caster
- Temperature range of 14°F to 212°F
- 4 pieces per set
- Case quantity: 2 per case

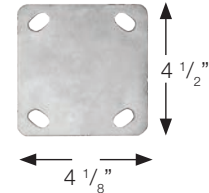

Model  
**28-180S**



## 6" Overall Sheet Pan Rack Stem Caster for Aluminum Racks

- 5" grease resistant locking wheels with side brakes
- Raises height of equipment 6"
- Weight capacity 220 lbs. per caster
- Temperature range of 14°F to 212°F
- 4 pieces per set
- Case quantity: 4 per case

Model  
**28-130S**

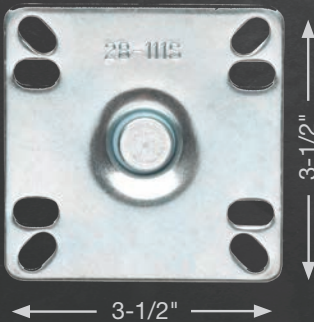

**Need assistance with choosing the correct caster?  
We got you covered!**

**1 Visit [krowne.com/crossover](http://krowne.com/crossover)**  
Enter your equipment's model number to pull up the correct caster.

**2 We offer actual size print-outs of our caster plates on [krowne.com](http://krowne.com)**  
Simply print and hold it up to your equipment to confirm the match!

## Economy Casters

### 6" Overall 4" x 4" Universal Plate Caster

- Fits most manufacturers
- Universal 4" x 4" plate
- 5" grease resistant wheels
- Weight capacity 200 lbs per caster
- 4 pieces per set (2 w/brake, 2 without)
- Case Quantity: 4 per case

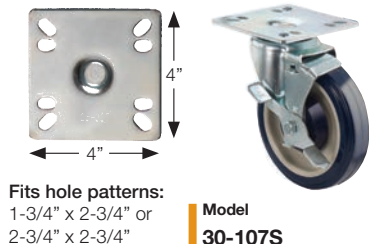

### 6" Overall 3-1/2" x 3-1/2" Universal Plate Caster

- Fits most manufacturers
- Universal 3-1/2" x 3-1/2" plate
- 5" grease resistant wheels with 4 side brakes
- Weight capacity 200 lbs per caster
- 4 pieces per set
- Case Quantity: 4 per case

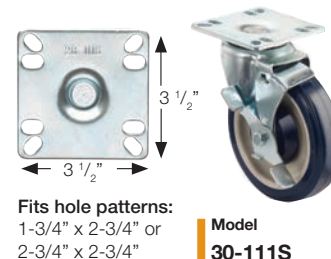

### 6" Overall 2-3/8" x 3-5/8" Plate Caster

- 2-3/8" x 3-5/8" plate
- 5" grease resistant wheels
- Weight capacity 200 lbs per caster
- 4 pieces per set (2 w/brake, 2 without)
- Case Quantity: 4 per case

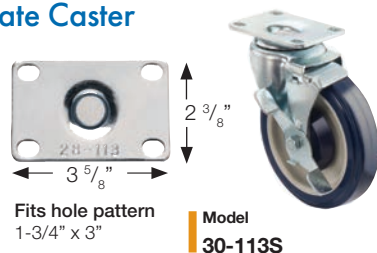

### 6" Overall Universal Wire Shelving Caster

- Fits standard 1" diameter wire shelving posts
- 5" grease resistant wheels with 4 side brakes
- Weight capacity 200 lbs per caster
- 4 pieces per set
- Case Quantity: 4 per case



### 6" Overall 1-5/8" Stem Worktable Caster

Used on Standard 1-5/8" Diameter Legs

- Fits standard 1-5/8" tubing
- Used on Worktables
- 5" grease resistant wheels with 4 side brakes
- Weight capacity 200 lbs per caster
- 4 pieces per set
- Case Quantity: 4 per case



### 6" Overall 1-1/2" Stem Worktable Caster

Used on Standard 1-1/2" Diameter Legs

- Fits 1-1/2" tubing
- Used on Worktables
- 5" grease resistant wheels with 4 side brakes
- Weight capacity 200 lbs per caster
- 4 pieces per set
- Case Quantity: 6 per case



### Adjustable 8-1/2" - 10-1/2" Height Plate Caster for Fryers

Fits Pitco\* Fryers

- 3-1/2" x 3-1/2" plate
- 3" grease resistant wheels with 4 side brakes
- Weight capacity 200 lbs per caster
- 4 pieces per set
- Case Quantity: 4 per case

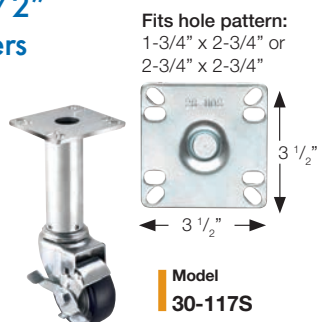

### 6" Overall Heavy Duty Large Triangle Plate Caster

Fits Blodgett\* Convection Ovens

- 5-3/8" x 5-3/8" x 7-1/2" triangle plate caster
- 5" Grease resistant wheels
- Heavy Duty weight capacity 500 lbs per caster
- 4 pieces per set (2 w/brake, 2 without)
- Case Quantity: 3 per case



### 6" Overall 3/4" Threaded Stem Caster For Ranges and Ovens

- 1" long threaded stem
- 5" grease resistant wheels, 3/4" - 10 Thread
- Weight capacity 200 lbs per caster
- 4 pieces per set (2 w/brake, 2 without)
- Case Quantity: 4 per case



### 6" Overall Low Profile 1/2" - 13 Threaded Stem Caster Threaded for Refrigeration

- 1" long threaded stem
- 5" Grease resistant wheels
- Weight capacity 200 lbs per caster
- 4 pieces per set (2 w/brake, 2 without)
- Case Quantity: 4 per case



\*This product is not manufactured or authorized by any other manufacturer. Registered Trade Name or Mark of the original manufacturer of the product which this part fits, is not owned, associated or to be confused with our company.

**Index**

10-400L-W ..... 59	14-812L-W-E4 ..... 28	16-108L ..... 62	16-331L ..... 37	19-229L ..... 64
10-435L ..... 59	14-814L ..... 28	16-109L ..... 62	16-332L ..... 37	19-301 ..... 104
10-435L-W ..... 59	14-816L ..... 28	16-115L ..... 62	16-333L ..... 37	19-302 ..... 104
11-400L ..... 60	14-818L ..... 28	16-116L ..... 62	16-350L ..... 62	19-303 ..... 104
11-400L-W ..... 61	14-824L ..... 28	16-120L ..... 84	16-351L ..... 62	20-101L ..... 101
11-401L ..... 60	14-840L ..... 51	16-121L ..... 84	16-352L ..... 62	20-108L ..... 101
11-406L ..... 60, 63	14-841L ..... 51	16-127 ..... 33, 63	16-402L ..... 56	20-201L ..... 101
11-412L ..... 60	15-3XXL ..... 29	16-127-W ..... 33	16-405L ..... 56	20-203L ..... 101
11-435L ..... 60, 85	15-3XXL-W ..... 29	16-128 ..... 33, 63	16-406L ..... 76, 84	20-204L ..... 101
11-450L ..... 60, 63	15-4XXL ..... 31	16-129 ..... 33, 63	16-407L ..... 76, 84	20-208L ..... 101
11-460L ..... 60, 85	15-4XXL-W ..... 31	16-130L ..... 36	16-450L ..... 48	20-302 ..... 64
12-8XXL ..... 59	15-5XXL ..... 30	16-131L ..... 36	16-470L ..... 51	21-1XXL ..... 25
12-170L ..... 98	15-5XXL-W ..... 30	16-132L ..... 36	16-501 ..... 56	21-101L ..... 24
12-171L ..... 98	15-8XXL ..... 32	16-133L ..... 36	16-505 ..... 56	21-108L ..... 24
12-510L ..... 61	15-8XXL-W ..... 32	16-135L ..... 107	16-506 ..... 56	21-109L ..... 44
12-525L ..... 61	15-301L ..... 29	16-136L ..... 107	16-510 ..... 56	21-110L ..... 44
12-801L ..... 59	15-301L-W-E4 ..... 29	16-137L ..... 107	16-511 ..... 56	21-112L ..... 44
12-802L ..... 59	15-302L ..... 29	16-138L ..... 107	16-512 ..... 56	21-113L ..... 44
12-806L ..... 59	15-306L ..... 29, 33	16-139L ..... 107	16-513 ..... 57	21-114L ..... 44
12-808L ..... 59	15-308L ..... 29	16-140L ..... 36, 76	16-514 ..... 57	21-115L ..... 44
12-810L ..... 59	15-308L-W-E4 ..... 29	16-141L ..... 36	16-516 ..... 57	21-117L ..... 44
12-812L ..... 59	15-310L ..... 29	16-142L ..... 36	16-517 ..... 56	21-118L ..... 44
12-814L ..... 59	15-312L ..... 29	16-143L ..... 36	16-649 ..... 55	21-125L ..... 44
12-816L ..... 59	15-312L-W-E4 ..... 29	16-144 ..... 107	16-649P ..... 55	21-126 ..... 102
12-818L ..... 59	15-314L ..... 29	16-146 ..... 107	16-649P8 ..... 55	21-127L ..... 25
12-824L ..... 59	15-316L ..... 29	16-147 ..... 107	16-650 ..... 55	21-129L ..... 25
13-8XXL ..... 62	15-325L ..... 29	16-149 ..... 107	16-650P ..... 55	21-130L ..... 25
13-222L ..... 98	15-325L-W-E2 ..... 29	16-150 ..... 107	16-650P8 ..... 55	21-131L ..... 25, 99, 100
13-223L ..... 98	15-350L ..... 29, 33	16-151L ..... 107	16-654 ..... 54	21-132L ..... 25, 101
13-225L ..... 98	15-401L ..... 31	16-152L ..... 107	16-654P ..... 54	21-133L ..... 25
13-801L ..... 62	15-401L-W-E4 ..... 31	16-153L ..... 107	16-654P8 ..... 54	21-134L ..... 25
13-802L ..... 62	15-402L ..... 31	16-155L ..... 107	16-655 ..... 55	21-135L ..... 25, 100, 101
13-806L ..... 62	15-406L ..... 31	16-160L ..... 35	16-656 ..... 55	21-136L ..... 25, 99
13-808L ..... 62	15-408L ..... 31	16-161L ..... 35	16-670 ..... 15, 53	21-137 ..... 24
13-810L ..... 62	15-408L-W-E4 ..... 31	16-162L ..... 35	16-675 ..... 15, 53	21-138L ..... 25
13-812L ..... 62	15-410L ..... 31	16-163L ..... 35	17-124WL ..... 21	21-139L ..... 25
13-814L ..... 62	15-412L ..... 31	16-165 ..... 107	17-204WL ..... 20	21-140L ..... 25
13-816L ..... 62	15-412L-W-E4 ..... 31	16-170L ..... 36	17-206WL ..... 19	21-141L ..... 25
13-818L ..... 62	15-414L ..... 31	16-171L ..... 36	17-208WL ..... 20	21-142 ..... 25
13-824L ..... 62	15-418L ..... 31	16-178L ..... 35	17-310 ..... 21	21-143 ..... 25
14-4XXL ..... 27	15-425L ..... 31	16-179L ..... 35	17-312WL ..... 21	21-144 ..... 100, 101
14-4XXL-W ..... 27	15-425L-W-E2 ..... 31	16-181L ..... 35	17-XXXL ..... 25	21-145 ..... 25
14-8XXL ..... 28	15-501L ..... 30	16-182L ..... 35	18-1C ..... 86	21-148 ..... 25
14-8XXL-W ..... 28	15-501L-W-E4 ..... 30	16-186 ..... 57	18-12DST ..... 86	21-149L ..... 25
14-400L ..... 27	15-502L ..... 30	16-189 ..... 57	18-18ST ..... 86	21-160-3L ..... 22
14-400L-W-E2 ..... 27	15-506L ..... 30	16-190 ..... 53	18-406L ..... 23	21-160-8L ..... 22, 23
14-401L ..... 27	15-508L ..... 30	16-191 ..... 53	18-408L ..... 23	21-160-24L ..... 24
14-401L-W-E4 ..... 27	15-508L-W-E4 ..... 30	16-196 ..... 54	18-506L ..... 23	21-160L ..... 24
14-402L ..... 27	15-510L ..... 30	16-196P ..... 54	18-508L ..... 23	21-161L ..... 24
14-406L ..... 27	15-512L ..... 30	16-196P8 ..... 54	18-606L ..... 23	21-162 ..... 24
14-406L-W-E4 ..... 27	15-512L-W-E4 ..... 30	16-197 ..... 53	18-608L ..... 23	21-163 ..... 23
14-408L ..... 27	15-514L ..... 30	16-198 ..... 56, 74	18-706L ..... 23	21-164L ..... 24
14-410L ..... 27	15-516L ..... 30	16-199 ..... 56, 57	18-708L ..... 23	21-165 ..... 24
14-410L-W-E4 ..... 27	15-525L ..... 30	16-200L ..... 37	18-725L ..... 22	21-166L ..... 24
14-510L ..... 46	15-525L-W-E2 ..... 30	16-201L ..... 37	18-812L ..... 34	21-168 ..... 24
14-520L ..... 49	15-601L ..... 34	16-202L ..... 37	18-814L ..... 34	21-170 ..... 24
14-521L ..... 49	15-612L ..... 34	16-203L ..... 37	19-101L ..... 100	21-171 ..... 24
14-530L ..... 48	15-625L ..... 34	16-220L ..... 98	19-108L ..... 100	21-179L ..... 22, 24
14-546L ..... 50	15-801L ..... 32	16-232L ..... 84	19-112L ..... 99	21-181L ..... 21, 22, 23, 25
14-550L ..... 47	15-801L-W-E4 ..... 32	16-240L ..... 98	19-201L ..... 100	21-184L ..... 25
14-560L ..... 48	15-802L ..... 32	16-250L ..... 35	19-203L ..... 100	21-185L ..... 25
14-570L ..... 47	15-806L ..... 32	16-251L ..... 35	19-204L ..... 100	21-190L ..... 39
14-580L ..... 47	15-808L ..... 32	16-252L ..... 35	19-208L ..... 100	21-191L ..... 39
14-801L ..... 28	15-808L-W-E4 ..... 32	16-253L ..... 35	19-220L ..... 64	21-192L ..... 39
14-801L-W-E4 ..... 28	15-810L ..... 32	16-281 ..... 63	19-221L ..... 64	21-193L ..... 39
14-802L ..... 28	15-812L ..... 32	16-282 ..... 63	19-222L ..... 64	21-194L ..... 39
14-802L-W-E4 ..... 28	15-812L-W-E4 ..... 32	16-283 ..... 63	19-223L ..... 64	21-195L ..... 19, 37, 47, 48
14-806L ..... 28	15-814L ..... 32	16-301L ..... 37	19-224L ..... 64	21-196L ..... 39
14-808L ..... 28	15-818L ..... 32	16-302L ..... 37	19-225L ..... 64	21-198L ..... 39, 84
14-808L-W-E4 ..... 28	15-825L ..... 32	16-306L ..... 37	19-226L ..... 64	21-199L ..... 39
14-810L ..... 28	15-825L-W-E2 ..... 32	16-312L ..... 37	19-227L ..... 64	21-201L ..... 24
14-812L ..... 28	16-33XL ..... 37	16-330L ..... 37	19-228L ..... 64	21-202L ..... 24

21-204L.....	24	21-450L.....	44	22-600L.....	45	28-110S.....	111	30-550.....	105
21-208L.....	24	21-451.....	84	22-602L.....	45	28-111S.....	111	A1616.....	96
21-227L.....	41	21-452L.....	42	22-603L.....	45	28-113S.....	112	A1620.....	96
21-228L.....	41	21-455L.....	44	22-604L.....	45	28-114S.....	109	A1625.....	96
21-229L.....	41	21-458L.....	34, 41	22-605L.....	45	28-115S.....	111	A2016.....	96
21-300L.....	64	21-460L.....	34, 41	22-608L.....	45	28-116S.....	111	A2020.....	96
21-302L.....	24, 25	21-461L.....	34, 41	22-609L.....	45	28-117S.....	109	A2025.....	96
21-305.....	64	21-463L.....	34, 41	22-610L.....	45	28-118S.....	110	A2520.....	96
21-306.....	40	21-465L.....	41	22-611L.....	45	28-120S.....	112	BS-1818.....	86
21-308L.....	18, 20, 21, 40	21-467L.....	41	22-615.....	68	28-124S.....	110	BS-1818-LF.....	86
21-309L.....	18, 20, 21, 40	21-469L.....	41	22-616.....	68	28-125S.....	110	C50.....	93
21-310L.....	64	21-500L.....	43	22-620L.....	45	28-129S.....	110	C75.....	93
21-311.....	40, 84	21-524L.....	44	22-621L.....	45	28-130S.....	116	C100.....	93
21-312.....	64	21-525L.....	43	22-622L.....	45	28-135S.....	109	C125.....	93
21-313.....	40, 47	21-527L.....	43	22-625L.....	45	28-136S.....	113	C5024K.....	92
21-320L.....	43	21-528L.....	43	22-626L.....	45	28-139S.....	115	C5036K.....	92
21-321L.....	43	21-532L.....	43	22-628L.....	45	28-140S.....	115	C5048K.....	92
21-325L.....	64	21-534L.....	43	22-631L.....	45	28-141S.....	115	C5060K.....	92
21-330L.....	40	21-545L.....	22, 44	22-632L.....	45	28-144S.....	115	C5072K.....	92
21-331L.....	40	21-546L.....	44	22-633L.....	45	28-145S.....	115	C7524K.....	92
21-332L.....	107	21-547L.....	25	22-634L.....	45	28-146S.....	115	C7536K.....	92
21-333L.....	40	21-561L.....	98, 99	22-640L.....	45	28-147S.....	115	C7548K.....	92
21-334L.....	40	21-565L.....	98, 99	22-650L.....	45	28-151S.....	112	C7560K.....	92
21-340L.....	61	21-600L.....	98, 99	22-671L.....	15, 53	28-156S.....	110	C7572K.....	92
21-341.....	61	21-620L.....	98, 99	22-672L.....	15, 53	28-158S.....	110	C10024K.....	92
21-344L.....	47, 62	21-640L.....	98, 99	22-800.....	66	28-160S.....	109	C10036K.....	92
21-345L.....	37, 46, 49	21-643L.....	98, 99	22-850.....	66	28-161S.....	115	C10048K.....	92
21-346L.....	37, 46, 49	21-670.....	22	22-851.....	66	28-164S.....	113	C10060K.....	92
21-350L.....	34, 40	22-201.....	67	23-110.....	69	28-166S.....	116	C10072K.....	92
21-351L.....	34, 40	22-204.....	67	23-111.....	69	28-168S.....	114	C12524K.....	92
21-355L.....	64	22-404.....	67	23-111-A.....	69	28-169S.....	114	C12536K.....	92
21-363L.....	48	22-500.....	68	23-118.....	69	28-170S.....	114	C12548K.....	92
21-400L.....	64	22-501.....	68	23-120.....	69	28-171S.....	114	C12560K.....	92
21-401L.....	42	22-502.....	68	23-121.....	69, 84	28-172S.....	113	C12572K.....	92
21-402L.....	42	22-503.....	68	23-122.....	69	28-174S.....	113	CS-1836.....	86
21-403L.....	42	22-504.....	68	23-123.....	69, 74	28-180S.....	116	CS-1860.....	86
21-404L.....	41	22-505.....	68	23-130.....	69	28-185S.....	115	CS-1872.....	86
21-405L.....	41	22-507.....	68	23-138.....	69	28-193S.....	114	D278.....	106
21-407.....	42	22-508.....	66	23-145.....	33, 63	28-194S.....	114	D278-7.....	106
21-420L.....	41	22-509.....	66	23-152.....	69	28-200.....	94	D2712.....	106
21-420L-X.....	41	22-515.....	68	23-153.....	69	28-201.....	94	D2712-7.....	106
21-421L.....	41	22-516.....	68	23-154.....	70	28-260S.....	112	D2712-10.....	106
21-421L-X.....	41	22-519.....	68	23-155.....	70	29-101.....	105	D2712DP.....	106
21-422L.....	41	22-528.....	68	23-156.....	70	29-108.....	105	DX-1XX.....	12
21-422L-X.....	41	22-529.....	68	23-157.....	84	29-158.....	103	DX-3XX.....	13
21-423L.....	41	22-530.....	68	23-159.....	69	29-160.....	103	DX-4XX.....	13
21-423L-X.....	41	22-532.....	66	24-502.....	102	29-162.....	105	DX-6XX.....	13
21-424L.....	41	22-533.....	66	24-503.....	102	30-107S.....	117	DX-8XX.....	13
21-424L-X.....	41	22-534.....	66	24-600.....	102	30-111S.....	117	DX-9XX.....	13
21-425L.....	41	22-540.....	67	24-602.....	102	30-113S.....	117	DX-100.....	14
21-425L-X.....	41	22-572L.....	45	24-603.....	102	30-117S.....	117	DX-108.....	11
21-426L.....	41	22-573L.....	45	24-700.....	102	30-125S.....	117	DX-109.....	11
21-427L.....	41	22-574L.....	45	24-702.....	102	30-129S.....	117	DX-129.....	12
21-427L-X.....	41	22-575L.....	45	25-100.....	104	30-141.....	87	DX-133.....	12
21-428L.....	41	22-576L.....	45	25-101.....	104	30-141S.....	117	DX-137.....	12
21-428L-X.....	41	22-577L.....	45	25-102.....	104	30-145.....	87	DX-138.....	12
21-429L.....	41	22-578L.....	45	25-103.....	104	30-146S.....	117	DX-139.....	12
21-429L-X.....	41	22-579L.....	45	25-104.....	104	30-147.....	87	DX-140.....	12
21-430L.....	41	22-580L.....	45	25-112.....	104	30-148.....	87	DX-141.....	12
21-430L-X.....	41	22-581L.....	45	25-113.....	104	30-150.....	87	DX-149.....	12
21-431L.....	41	22-584L.....	45	25-118.....	104	30-151S.....	117	DX-160.....	12
21-431L-X.....	41	22-585L.....	45	25-120.....	104	30-152.....	87	DX-160-24.....	12
21-432L.....	41	22-586L.....	45	25-125.....	104	30-153.....	87	DX-161.....	12
21-432L-X.....	41	22-587L.....	45	25-128.....	104	30-160.....	87	DX-162.....	12
21-433L.....	15, 53	22-588L.....	45	25-129.....	104	30-161S.....	117	DX-165.....	12
21-434L.....	15, 53	22-589L.....	45	25-150.....	39	30-317.....	104	DX-166.....	12
21-440L.....	38	22-591L.....	45	25-200.....	103	30-318.....	104	DX-171.....	12
21-441L.....	35, 41	22-592L.....	45	25-200S.....	103	30-324.....	105	DX-179.....	12
21-442L.....	35, 41	22-593L.....	45	25-201S.....	103	30-325.....	105	DX-201.....	12
21-443L.....	38, 84	22-594L.....	45	28-101S.....	111	30-330.....	105	DX-202.....	11
21-444L.....	38	22-598L.....	45	28-107S.....	111	30-335.....	105	DX-208.....	12
21-445L.....	14, 38	22-599L.....	45	28-109S.....	111	30-502.....	105	DX-301.....	13

**Index**

DX-302.....	13	H-110.....	84	HS-1317.....	85	M7560K.....	89	M12560K5.....	91
DX-306.....	13	H-111.....	83	HS-1419.....	85	M7560K2.....	91	M12560K9.....	89
DX-308.....	13	H-115.....	83	HS-1425.....	85	M7560K5.....	91	M12560K10.....	90
DX-310.....	13	H-116.....	83	HS-1515.....	85	M7560K9.....	89	M12560K12.....	90
DX-312.....	13	H-121.....	83	HS-2017.....	85	M7560K10.....	90	M12572.....	91, 92
DX-314.....	13	H-122.....	83	HS-2619.....	86	M7560K12.....	90	M12572K.....	89
DX-316.....	13	H-145.....	83	HS-2619-LF.....	86	M7572.....	91, 92	M12572K2.....	91
DX-322.....	12	H-160.....	83	HS-3819.....	86	M7572K.....	89	M12572K5.....	91
DX-325.....	13	H-162.....	83	HS-3819-LF.....	86	M7572K2.....	91	M12572K9.....	89
DX-400.....	13	H-165.....	83	KR-FC.....	97	M7572K5.....	91	M12572K10.....	90
DX-401.....	13	HS-1.....	81	KR-HS1-KIT.....	97	M7572K9.....	89	M12572K12.....	90
DX-402.....	13	HS-2L.....	72	KR-HS2-KIT.....	97	M7572K10.....	90	MH-5.....	33, 63
DX-406.....	13	HS-2-LF.....	77	KR-HS3-KIT.....	97	M7572K12.....	90	MH-24.....	33, 63
DX-408.....	13	HS-2-LS.....	73	KR-HSA.....	97	M10024.....	91, 92	MS-1818.....	33, 63
DX-410.....	13	HS-2-RS.....	73	KR-SF.....	97	M10024K.....	89	MS-2424.....	33, 63
DX-420.....	14	HS-4.....	72	M5024.....	91, 92	M10024K2.....	91	P25-123.....	103
DX-421.....	14	HS-5.....	73	M5024K.....	89	M10024K5.....	91	P25-124.....	103
DX-422.....	14	HS-7.....	75	M5024K2.....	91	M10024K9.....	89	P25-126.....	103
DX-423.....	14	HS-8.....	75	M5024K5.....	91	M10024K10.....	90	P25-127.....	103
DX-424.....	14	HS-9L.....	78	M5024K9.....	89	M10024K12.....	90	P25-140.....	103
DX-425.....	14	HS-9-LF.....	79	M5024K10.....	90	M10036.....	91, 92	P30-318.....	104
DX-426.....	14	HS-9-LS.....	78	M5024K12.....	90	M10036K.....	89	QD50.....	93
DX-430.....	14	HS-9-RS.....	78	M5036.....	91, 92	M10036K2.....	91	QD75.....	93
DX-431.....	14	HS-9S-LF.....	79	M5036K.....	89	M10036K5.....	91	QD100.....	93
DX-432.....	14	HS-10.....	72	M5036K2.....	91	M10036K9.....	89	QD125.....	93
DX-601.....	13	HS-11.....	74	M5036K5.....	91	M10036K10.....	90	R24.....	93
DX-602.....	13	HS-11-LF.....	77	M5036K9.....	89	M10036K12.....	90	R36.....	93
DX-625.....	13	HS-12.....	74	M5036K10.....	90	M10048.....	91, 92	R48.....	93
DX-708.....	14	HS-13.....	74	M5036K12.....	90	M10048K.....	89	R60.....	93
DX-709.....	14	HS-14.....	76	M5048.....	91, 92	M10048K2.....	91	R72.....	93
DX-801.....	13	HS-15.....	76	M5048K.....	89	M10048K5.....	91	RB7550.....	93
DX-802.....	13	HS-16.....	76	M5048K2.....	91	M10048K9.....	89	RG50.....	94
DX-806.....	13	HS-18.....	72	M5048K5.....	91	M10048K10.....	90	RG75.....	94
DX-808.....	13	HS-18-LF.....	77	M5048K9.....	89	M10048K12.....	90	RL50.....	94
DX-810.....	13	HS-19.....	81	M5048K10.....	90	M10060.....	91, 92	RL75.....	94
DX-812.....	13	HS-20-LF.....	77	M5048K12.....	90	M10060K.....	89	RS1616.....	96
DX-814.....	13	HS-21.....	78	M5060.....	91, 92	M10060K2.....	91	RS1620.....	96
DX-816.....	13	HS-22.....	72	M5060K.....	89	M10060K5.....	91	RS1625.....	96
DX-818.....	13	HS-26L.....	73	M5060K2.....	91	M10060K9.....	89	RS2020.....	96
DX-901.....	13	HS-26-LF.....	73	M5060K5.....	91	M10060K10.....	90	RS2025.....	96
DX-902.....	13	HS-30L.....	78	M5060K9.....	89	M10060K12.....	90	RS2520.....	96
DX-906.....	13	HS-30-LF.....	79	M5060K10.....	90	M10072.....	91, 92	S25-123.....	103
DX-908.....	13	HS-31.....	80	M5060K12.....	90	M10072K.....	89	S25-124.....	103
DX-910.....	13	HS-32.....	80	M5072.....	91, 92	M10072K2.....	91	S25-126.....	103
DX-912.....	13	HS-33.....	75	M5072K.....	89	M10072K5.....	91	S25-127.....	103
DX-914.....	13	HS-34.....	82	M5072K2.....	91	M10072K9.....	89	S25-140.....	103
DX-916.....	13	HS-35.....	82	M5072K5.....	91	M10072K10.....	90	S1020.....	96
DX-918.....	13	HS-36.....	82	M5072K9.....	89	M10072K12.....	90	S1616.....	96
E50.....	93	HS-37.....	80	M5072K10.....	90	M12524.....	91, 92	S1620.....	96
E75.....	93	HS-39.....	76	M5072K12.....	90	M12524K.....	89	S1625.....	96
E100.....	93	HS-40.....	76	M7524.....	91, 92	M12524K2.....	91	S2016.....	96
E125.....	93	HS-41.....	76	M7524K.....	89	M12524K5.....	91	S2020.....	96
FG-L2.....	84	HS-42.....	76	M7524K2.....	91	M12524K9.....	89	S2025.....	96
FG-LR2.....	84	HS-43.....	72	M7524K5.....	91	M12524K10.....	90	S2520.....	96
FG-R2.....	84	HS-50.....	82	M7524K9.....	89	M12524K12.....	90	S5036.....	94
G50.....	93	HS-51.....	82	M7524K10.....	90	M12536.....	91, 92	S5048.....	94
G75.....	93	HS-53.....	82	M7524K12.....	90	M12536K.....	89	S7536.....	94
G100.....	93	HS-56.....	75	M7536.....	91, 92	M12536K2.....	91	S7548.....	94
G125.....	93	HS-58.....	75	M7536K.....	89	M12536K5.....	91	SG-L2.....	84
G1616.....	96	HS-61.....	81	M7536K2.....	91	M12536K9.....	89	SG-LR2.....	84
G1620.....	96	HS-62.....	81	M7536K5.....	91	M12536K10.....	90	SG-R2.....	84
G1625.....	96	HS-64.....	79	M7536K9.....	89	M12536K12.....	90	SW50.....	93
G2016.....	96	HS-65.....	79	M7536K10.....	90	M12548.....	91, 92	SW75.....	93
G2020.....	96	HS-67.....	74	M7536K12.....	90	M12548K.....	89	SW100.....	93
G2025.....	96	HS-68.....	74	M7548.....	91, 92	M12548K2.....	91	SW125.....	93
G2520.....	96	HS-69.....	74	M7548K.....	89	M12548K5.....	91	WB-1712.....	84
H-100.....	84	HS-70.....	74	M7548K2.....	91	M12548K9.....	89	WB-1715.....	84
H-101.....	57, 83	HS-74.....	87	M7548K5.....	91	M12548K10.....	90	WS-1.....	106
H-105.....	83	HS-1016.....	85	M7548K9.....	89	M12548K12.....	90	WS-2.....	106
H-108-1.....	84	HS-1025.....	85	M7548K10.....	90	M12560.....	91, 92		
H-108-2.....	84	HS-1220.....	85	M7548K12.....	90	M12560K.....	89		
H-108-9.....	84	HS-1225.....	85	M7560.....	91, 92	M12560K2.....	91		



**1. PRICES** All previous prices are currently withdrawn.

**2. ACCEPTANCE**

If the terms and conditions herein (the "Terms and Conditions") differ in any way from the terms and conditions of Buyer's order, or if these Terms and Conditions are construed as an acceptance or confirmation acting as an acceptance, then the Seller's acceptance is EXPRESSLY CONDITIONED ON BUYER'S ACCEPTANCE OF AND AGREEMENT TO ANY TERMS AND CONDITIONS SET FORTH HEREIN, THAT ARE DIFFERENT FROM OR ADDITIONAL TO THOSE IN BUYER'S ORDER. In addition, this writing shall constitute notice of objection to any terms and conditions in Buyer's order that differ from, or are in addition to, the Terms and Conditions herein. If the Terms and Conditions herein are construed as an offer, acceptance of such offer is EXPRESSLY LIMITED TO THE TERMS AND CONDITIONS SET FORTH HEREIN. In any event, Buyer's acceptance of goods from Seller shall constitute Buyer's acceptance of and agreement to the Terms and Conditions. These Terms and Conditions shall not be supplemented or modified except as agreed to in writing and signed by Seller.

**3. EXPRESS WARRANTIES, CONDITIONS, & EXCLUSIONS**

**A. Warranty**

Subject to the conditions and exclusions set forth below, Seller warrants to Buyer (i) that Seller holds and will pass marketable title to the goods sold hereunder; (ii) that the goods sold hereunder will be free from defects in materials and workmanship (subject to tolerances and variances permitted by the trade hereunder) for the applicable warranty period set forth in Seller's standard warranty and limitation of liability (the "Standard Warranty"), provided, however, that the glasswasher shall have a one (1) year labor warranty and refrigeration parts shall have a one (1) year labor and parts warranty.

**B. Conditions and Exclusions**

The express warranty set forth above (the "Warranty") is subject to the following conditions and exclusions: (i) Buyer shall not assign its rights under the Warranty and any attempt by Buyer to assign such rights shall render the Warranty, but not any disclaimers or limitations, void, and the goods shall be sold AS IS; (ii) all goods shall be carefully installed by persons who are trained and certified professionals with respect to such installations, and be installed, used, repaired and maintained by Buyer in accordance with all applicable local laws, codes and regulations; (iii) goods covered by the Warranty shall be warranted in connection with original installation only; (iv) Seller shall not be liable by Buyer's failure to provide a continuously suitable environment, including, without limitation, neglect or misuse, failure or sudden surge of electrical power, improper air conditioning or humidity control or any other cause other than ordinary use; (v) Seller shall not be liable for any damage arising from the use of any goods in any application other than the commercial and industrial applications for which they are intended; (vi) Seller shall not be liable for damage caused by fire, flood, earthquake, water, severe wind, lightning or other natural disaster, strike, inability to obtain materials or utilities, war, terrorism, civil disturbance or any other cause beyond Seller's reasonable control; and (vi) Seller shall not be liable for any statements made about the goods by salesmen, dealers, distributors or agents, unless such statements are in a written document signed by an officer of Seller.

**4. DISCLAIMER OF IMPLIED WARRANTIES**

Seller makes no other warranties or conditions, express or implied, included, without limitation, the implied warranties or conditions of merchantability and fitness for a particular purpose. Specifically, except as provided herein and in the standard, seller undertakes no responsibility for the quality or the goods or that the goods will be fit for any particular purpose for which purchaser may be buying the goods. Any implied warranty is limited in duration to the warranty period. No oral or written information, or advice given by the company, its agents or employees, shall create a warranty or in any way increase the scope of this limited warranty.

**5. LIMITATIONS OF LIABILITY**

Buyer acknowledges that the following limitations of Seller's liability are fair and reasonable and shall apply to any act or omission hereunder, as well as to any breach of contract to which these Terms and conditions form a part.

**A. Disclaimer of Damages**

In no event shall seller (including its subsidiaries, affiliates, officers, directors, employees, or agents) be liable for any special, consequential, incidental or exemplary damages arising out of or in any way connected with the goods or otherwise, including, without limitation, to damages for lost profits, cost of substitute or replacement goods, down time, lost data, injury to property or any damages or sums paid by buyer to third parties, even if seller has been advised of the possibility of such damages. The foregoing limitation or liability shall apply whether any claim is based upon principles of contract, tort or statutory duty, principles of indemnity or contribution, or otherwise.

In no event shall seller be liable to buyer or any other party for loss, damage, or injury of any kind of nature arising out of or in connection with this warranty in excess of the purchase price of the goods actually delivered to and paid for by the buyer. The buyer's remedy in any dispute under this warranty shall be ultimately limited to the purchase price of the goods to the extent the purchase price has been paid.

**B. Notice and Time of Claims**

Buyer agrees (i) to check and inspect all products against shipping papers and for damage or shortage upon receipt of goods at destination; (ii) that any claim for loss, damage in transit, or other cause visible upon inspection shall be made within

five (5) days of receipt; (iii) that the parties expressly waive the statute of limitations and that any legal proceeding for any cause of action arising from or relating to this contract shall be waived unless commenced within two (2) years after the accrual of such cause of action.

**6. ATTORNEY'S FEES**

Buyer agrees to reimburse Seller for any costs and expenses, including reasonable attorney's fees, incurred by Seller as a result of any breach or default by Buyer of its obligations hereunder.

**7. TERMS**

Net 30 Days for those firms furnishing satisfactory credit reference. Interest on accounts overdue more than thirty (30) days will be charged at a rate of 2% per month or the highest rate permitted by law, whichever is lower (the "Overdue Rate").

**8. QUOTATIONS**

Unless otherwise stated, quotations are for 90 day acceptance.

**9. MINIMUM ORDER** \$25.00 Net.

**10. SHIPPING TERMS**

The method of shipment and carrier shall be determined by Seller unless Buyer shall have specified a method of shipment and carrier (more) than ten (10) days prior to scheduled shipment. Title and all risks of loss or damage shall pass to Buyer upon delivery to carrier. We are not responsible for any delays in delivery which are beyond our control such as fires, strikes, delays in transportation or any similar contingencies. We reserve the right to ship via carriers that in our opinion are the most efficient. Where possible, customer's routing will be followed. All orders shipped prepaid will have a nominal administration charge per freight bill.

**11. RETURNS**

Custom and modified equipment, Rotary and Front Door Style Glass Washers, and Underbar Workstations without cold plates are not returnable. Return authorization for all other items must be requested within 90 days. All underbar and refrigeration equipment may only be returned with original white protective film in place. No returns are to be made to Seller without first obtaining a return authorization. No returns will be accepted or credited without such prior authorization and returns may be subject to a restocking charge of 25% of the purchase price plus transportation charges.

**12. SHORTAGE**

Krowne must be notified in writing within 5 days of receipt of shipment.

**13. TAXES**

Buyer will pay when due any and all taxes, tariffs, fees and assessments or any other similar charges imposed upon this contract, the goods covered hereby or the delivery, installation, use or resale thereof. If Buyer fails to pay any such amount when due, Seller may elect to pay it and Buyer shall promptly reimburse Seller for such payment, together with interest at the Overdue Rate.

**14. GOVERNING LAW**

This agreement, and all matters arising hereunder, shall be interpreted and resolved in accordance with the laws of the State of New Jersey, without giving effect to conflict of law of principles and excluding the United Nations Convention on the International Sale of Goods. Buyer and Seller submit to the personal jurisdiction of the state and federal courts of the State of New Jersey and agree that such courts will have jurisdiction over them in connection with any matter relating to or arising under this agreement. Service of process may be made by registered or certified mail, return receipt requested, to the last known address of the party being served. Process may also be served by any other legal means and Seller may bring an action with respect to any such matter in another jurisdiction.

**15. PRINTS AND DRAWINGS**

All prints and drawings submitted with orders will be accepted as correct sizes and any errors arising from the same will be the responsibility of the Buyer. There are no returns or cancellations for equipment built to your specifications.

**16. PRODUCT IMPROVEMENT**

Due to our commitment to continued product improvement, specifications are subject to change without notice.

**17. MISCELLANEOUS**

If any of the foregoing Terms and Conditions is declared illegal or unenforceable by a court of competent jurisdiction, it will be ineffective only to the extent of such illegality or unenforceability, without affecting the validity and enforceability, without affecting the validity and enforceability of the other Terms and Conditions. The headings used herein are inserted for convenience of reference of these Terms and Conditions. All prices are in U.S. Dollars.

California's Proposition 65 requires that consumers in the state of California receive the following notice:

 Warning: This product contains chemicals including lead and lead compounds known to the State of California to cause cancer, birth defects or other reproductive harm. For more information go to [www.p65warnings.ca.gov](http://www.p65warnings.ca.gov).

\*Krowne products are not manufactured or authorized by any other manufacturer. Registered Trade Name or Mark of the original manufacturer of the product which this part fits, is not owned, associated or to be confused with our company.

This Standard Warranty and Limitation of Liability (the "Warranty") sets forth the warranty provided by Krowne Metal Corporation (hereinafter "Krowne") with respect to the product purchased by Purchaser (the "Equipment"). By accepting delivery of the Equipment, Purchaser agrees to be bound by and accept these terms and conditions. All defined terms within the Warranty shall have the same meaning and definition as provided elsewhere in the Warranty. Equipment covered by the Warranty shall only be warranted in connection with its original installation only. KROWNE WILL ONLY BE OBLIGATED TO HONOR THE WARRANTY SET FORTH IN THESE TERMS AND CONDITIONS UPON RECEIPT OF FULL PAYMENT FOR THE EQUIPMENT.

**1. WARRANTY COVERAGE**

- A.** Subject to the conditions and exclusions set forth below, including, with respect to Diamond Series Plumbing, Purchaser's completion and delivery to Krowne of a warranty registration card or online Warranty registration, Krowne warrants to Purchaser that (i) Krowne holds and will pass marketable title to the goods sold hereunder, and (ii) the goods sold hereunder will be free from defects in materials and workmanship (subject to tolerances and variances permitted by the trade hereunder) for the applicable Warranty Period, as listed above (the "Warranty Period").
- B.** Krowne's obligation under this Warranty is limited to, at Krowne's option, replacing or repairing, any Equipment or part thereof that is found by Krowne not to conform to the Equipment's specifications. Krowne shall have a reasonable period of time to make such replacements or repairs and all labor associated therewith shall be performed during Krowne's regular working hours.
- C.** Krowne shall pay transportation charges for the return of any defective portion of the Equipment. If returned Equipment is repaired or replaced under the terms of this Warranty, Krowne will prepay transportation charges back to Purchaser; otherwise, Purchaser shall pay transportation charges to return the Equipment back to the Purchaser. All returns must be pre-approved by Krowne before shipment. Krowne shall not be obligated to pay freight for any unapproved return.
- D.** Any replacement parts or Equipment will be new, comparable in function and performance to the original part of Equipment, and warranted for the remainder of the Warranty Period. Purchasing additional parts or Equipment from Krowne does not extend this Warranty Period.
- E.** With regard to the Equipment, a defect shall refer to a variance from the design specifications that prohibit the Equipment from operating for its intended use. The Warranty provided by Krowne does not impose any duty or liability upon Krowne for degradation that occurs in the normal course over time, or due to improper installation of the Equipment by Purchaser or their representative.

THIS LIMITED WARRANTY IS THE ONLY WARRANTY APPLICABLE TO THE EQUIPMENT AND REPLACES ALL OTHER WARRANTIES OR CONDITIONS, EXPRESS OR IMPLIED, INCLUDING, WITHOUT LIMITATION, THE IMPLIED WARRANTIES OR CONDITIONS OF MERCHANTABILITY AND FITNESS FOR A PARTICULAR PURPOSE. SPECIFICALLY, EXCEPT AS PROVIDED HEREIN, KROWNE UNDERTAKES NO RESPONSIBILITY FOR THE QUALITY OF THE EQUIPMENT OR THAT THE EQUIPMENT WILL BE FIT FOR ANY PARTICULAR PURPOSE FOR WHICH PURCHASER MAY BE BUYING THE EQUIPMENT. ANY IMPLIED WARRANTY IS LIMITED IN DURATION TO THE WARRANTY PERIOD. NO ORAL OR WRITTEN INFORMATION, OR ADVICE GIVEN BY THE COMPANY, ITS AGENTS OR EMPLOYEES, SHALL CREATE A WARRANTY OR IN ANY WAY INCREASE THE SCOPE OF THIS LIMITED WARRANTY.

**2. EXCLUSION FROM WARRANTY COVERAGE**

The Warranty provided by Krowne does not impose any duty or liability upon Krowne for:

- A.** Any damage occurring, at any time, during shipping of Equipment unless otherwise provided for in the Agreement. When returning Equipment to Krowne for repair or replacement, Purchaser assumes all risk of loss or damage, and agrees to use any shipping containers that might be provided by Krowne and to ship the Equipment in the manner prescribed by Krowne;
- B.** Damage caused by the failure to provide a continuously suitable environment, but not limited to: (i) neglect or misuse, (ii) a failure or sudden surge of electrical power, (iii) improper air conditioning or humidity control, or (iv) any other cause other than ordinary use;
- C.** Damage caused by the unauthorized installation, adjustment, repair or service of the Equipment by anyone other than Krowne or Krowne's expressly authorized designee;
- D.** Damage caused by fire, flood, earthquake, water, severe wind, lightning or other natural disaster, strike, inability to obtain materials or utilities, war, terrorism, civil disturbance or any other cause beyond Krowne's reasonable control;
- E.** Failure to adjust, repair or replace any item of Equipment if it would be impractical for Krowne personnel to do so because of connection of the Equipment by mechanical or electrical means to another device not supplied by Krowne, or the existence of general environmental conditions at the site that pose a danger to Krowne personnel;
- F.** Any statements made about the product by salesmen, dealers, distributors or agents, unless such statements are in a written document signed by an officer of Krowne. Such statements as are not included in a signed writing do not constitute warranties, shall not be relied upon by Purchaser and are not part of the contract of sale;
- G.** Any damage arising from the use of Krowne products in any application other than the commercial and industrial applications for which they are intended, unless, upon request, such use is specifically approved in writing by Krowne; or
- H.** Any performance of preventive maintenance

**3. PURCHASER'S INSPECTION UPON RECEIPT OF EQUIPMENT**

All Equipment shall be carefully inspected by Purchaser upon receipt, be installed by persons who are trained and certified professionals with respect to such installations, and be installed, used, repaired and maintained by Purchaser in accordance with all applicable local laws, codes and regulations.

**4. LIFETIME WARRANTY PRODUCTS**

The Lifetime Warranty for the Krowne Metal Corporation Gas Hose ("Gas Hose") is valid solely for the lifetime and duration of the Equipment to which the Gas Hose is connected for operation (the "Lifetime Warranty"). For the avoidance of doubt, the Lifetime Warranty shall be deemed expired on the same Warranty Period expiration date applicable to the Equipment to which the Gas Hose is connected.

**5. LIMITATION OF LIABILITY**

In no event shall Krowne (including its subsidiaries, affiliates, officers, directors, employees, or agents) be liable for any special, consequential, incidental or exemplary damages arising out of or in any way connected with the Equipment or otherwise, including, without limitation, to damages for lost profits, cost of substitute or replacement Equipment, down time, lost data, injury to property or any damages or sums paid by Purchaser to third parties, even if Krowne has been advised of the possibility of such damages. The foregoing limitation of liability shall apply whether any claim is based upon principles of contract, tort or statutory duty, principles of indemnity or contribution, or otherwise.

In no event shall Krowne be liable to Purchaser or any other party for loss, damage, or injury of any kind or nature arising out of or in connection with this Warranty in excess of the purchase price of the Equipment actually delivered to and paid for by the Purchaser. The Purchaser's remedy in any dispute under this Warranty shall be ultimately limited to the Purchase Price of the Equipment to the extent the Purchase Price has been paid.

**6. ASSIGNMENT OF RIGHTS**

The Warranty contained herein extends only to the original Purchaser of the Equipment and no attempt to extend the Warranty to any subsequent user or transferee of the Equipment shall be valid or enforceable without the express written consent of Krowne. Any attempt by Purchaser to assign this Warranty shall render the Warranty, but not any disclaimers or limitations, void, and the goods shall be sold AS IS.

**7. COMPONENT PASS THROUGH WARRANTY**

Except as provided herein, although Krowne does not warrant components, it will pass through any warranties received by third-party component suppliers, to the extent permitted by the terms and conditions of such warranties.

**8. NOTICE AND TIME OF CLAIMS**

Purchaser shall make any claim for loss or damage to Equipment sustained during shipment within five (5) days of receipt of such Equipment.

**9. DISPUTE RESOLUTION**

Any dispute between the parties will be resolved exclusively and finally by arbitration and conducted under the assigned arbitrator rules, except as otherwise provided below. The arbitration will be conducted before a single arbitrator. The arbitration shall be held in Essex County, New Jersey. Any decision rendered in such arbitration proceedings will be final and binding on each of the parties, and judgment may be entered thereon in any court of competent jurisdiction. This arbitration agreement is made pursuant to a transaction involving interstate commerce, and shall be governed by the Federal Arbitration Act.

**10. GOVERNING LAW**

Both parties consent to the application of the laws of the State of New Jersey to govern, interpret, and enforce all of Purchaser and Krowne's rights, duties, and obligations arising from, or relating in any manner to, the subject matter of this Warranty, without regard to conflict of law principles. In no event shall the rights and obligations of the parties under this warranty shall not be governed by the provisions of the United Nations Convention on Contracts for the International Sales of Goods of 1980.

Product Description	Warranty Period
Diamond Series Plumbing	Lifetime
Royal Series Plumbing	3 years
Silver Series Plumbing	1 year
Hand Sinks	1 year
Royal Series Underbar	1 year
Silver Series Underbar	1 year
Refrigeration*	1 year parts & labor, 5 year compressor
Glass Washers	1 year (parts & labor)
Gas Hoses	Lifetime

\*Includes draft beer coolers, bottle coolers, mug frosters, back bar refrigeration



## PURCHASE

✉ [orders@krowne.com](mailto:orders@krowne.com)

## CONTACT

✉ [customerservice@krowne.com](mailto:customerservice@krowne.com)

✉ [sales@krowne.com](mailto:sales@krowne.com)

☎ 800.631.0442

## FOLLOW

[f](#) [t](#) [in](#) @krowne

[@](#) [@krownemetal](#)

## VISIT

100 Haul Road  
Wayne, NJ 07470  
[krowne.com](http://krowne.com)



100 Haul Rd. Wayne, NJ 07470

[krowne.com](http://krowne.com)