

# *Ice-O-Matic*

Simply The Cleanest Ice Machines

PRODUCT GUIDE | VOLUME 22



ice  
is  
food.

# Ice-O-Matic®

Ice. Pure and Simple™

11100 East 45th Avenue | Denver, CO 80239

866.PUREICE | [iceomatic.com](http://iceomatic.com)



## Table of Contents

|   |           |
|---|-----------|
| About Ice-O-Matic<br>General Information<br>Model Number Guide<br>Ice Form Series Guide   | <b>2</b>  |
| <b>UCG Gourmet Series™</b><br>Undercounters   | <b>10</b> |
| <b>ICE Series™</b><br>Undercounters<br>ICE Series Cube Ice Makers<br>ICE Series Cube Ice Makers - Accessories   | <b>12</b> |
| <b>Elevation™</b><br>Elevation Features<br>Elevation Series Cube Ice Makers – 22” Modular<br>Elevation Series Cube Ice Makers – 30” Modular<br>Elevation Series Cube Ice Makers – 48” Modular<br>Elevation Series Modular - Accessories<br>Elevation Series Modular - SafeIce Sanitation System | <b>14</b> |
| <b>GEM Series PEARL Ice™</b><br>GEM Series Pearl Ice® Makers – Modular<br>GEM Series Pearl Ice® Makers / Ice & Water Dispensers<br>GEM Series Pearl Ice® Makers - Accessories   | <b>20</b> |
| <b>MFI Series™ Flake</b><br>MFI Series Flake Ice Makers – Modular<br>MFI Series Flake Ice Makers - Accessories  | <b>22</b> |
| Remote Condensers & Accessories<br>Countertop & Hotel Ice Dispensers<br>Ice Dispenser Accessories & Kits<br>Storage Bins & Accessories<br>Ice Machine & Bin Configurations<br>ICE Series Cube Ice Makers - Accessories  | <b>24</b> |
| Pricing   Contact Us  | <b>32</b> |



**WARRANTY SERVICE  
DIRECT**  
Calls answered 24/7/365  
**1-855-TECH-IOM**  
(1-855-832-4466)



# About us.

Located in Denver, Colorado, Ice-O-Matic is a leading global manufacturer of a wide range of commercial ice-making products including cube ice makers, Pearl Ice® ice makers, flake ice makers, storage bins, dispensers and water filters. Since 1952 we have developed new technologies and programs, such as our new Elevation Series™ of cubers which are more efficient for business and safer for the environment.

ice  
is  
food.



## Ice with a Clear Conscience

### Sustainability

Ice-O-Matic offsets the carbon footprint of its Denver factory by using recycled packaging materials. We also recycle our industrial and office waste products.

### Made in the U.S.A

A U.S.-based company with over 200 employees nationwide, Ice-O-Matic provides and creates American jobs. Ice-O-Matic is committed to producing quality products, and to the hundreds of workers who make it happen. Ice-O-Matic products are designed and assembled in America.

### ENERGY STAR®

Ice-O-Matic partners with ENERGY STAR and is dedicated to improving energy efficiency. Each ENERGY STAR certified ice maker can save businesses energy and money on their utility bills. When considering batch-type ice makers, ENERGY STAR certified systems can save, on average, about 1,200 kwh annually, or \$125/year in electricity bill costs.

## Sizing your ice maker

- Does the existing ice maker meet peak usage during the hottest time of the year?
- Where are the various ice stations in the establishment that will need ice?
- Will multiple ice stations be serviced from one or multiple ice makers?
- For future growth, consider building in at least 20 percent additional ice capacity on new installations.

## Approximate Ice Usage Per Day

### FOOD SERVICE

|               |   |
|---------------|---|
| Restaurant    | 1.5 lbs. per person   |
| Cocktail      | 3 lbs. per person/seat  |
| Quick Service | 5 oz. per 7-to 10-oz. drink<br>8 oz. per 12- to 16-oz. drink<br>12oz. per 18- to 24-oz. drink |

### LODGING

|            |                        |
|------------|------------------------|
| Guest Ice  | 5 lbs. per room        |
| Restaurant | 1.5 lbs. per person    |
| Cocktail   | 3 lbs. per person/seat |
| Catering   | 1 lb. per person       |

*NOTE: The charts above outlines the approximate required ice amount per day, depending on application usage.*



# Installation Considerations



## Allow Enough Space for the Following Elements

- The ice maker, bin and water filter
- Airflow

## Utilities

- What are the voltage and amperage characteristics of the electrical outlet that will be used for this ice maker?
- Is there a floor drain within 6 feet (1.8 meters)?
- Is there a water source with water shutoff?
- Are the utilities within 6 feet (1.8 meters) of the ice-maker location?

## Remote Installation

- Is there an outdoor condenser location above the ice maker?
- Is there easy roof access and penetration?
- Maximum precharged tubing line run considerations?

## Ice Maker Warranty

Every Ice-O-Matic ice maker is backed by a warranty that provides both parts and labor coverage. To register products, view the warranty details or check your warranty status, visit the "Warranty Registration" page at: [iceomatic.com/warranty](http://iceomatic.com/warranty).

### Cube Ice Makers – CIM and ICE Series

- Three years Parts/Labor
- Five years Parts on evaporators and compressors
- Seven years Parts on evaporators with IOM filter program (*U.S.A. and Canada only*)
- Includes remote condensers

### Flake Ice Makers – MFI Series

- Three years Parts/Labor
- Five years Parts coverage on the compressor

### Pearl Ice® Ice Makers – GEM Series

- Modular – Three years Parts and Labor
- Countertop Dispenser – Two years Parts/Labor
- Modular/Dispenser – Five years Parts coverage on the compressor
- GEMU090 Undercounter – Two years Parts/Labor

### Gourmet Ice Makers - UCG Series

- Three years Parts and Labor

### Dispensers – CD and IOD Series

- IOD Countertop Dispensers – Two years Parts warranty and one year Labor warranty

### Storage Bins

- Two years Parts/Labor
- CD Hotel Dispensers – Three years Parts/Labor warranty

### Water Filter Manifold Systems

- One year Parts/Labor (*excluding cartridges*)

### Accessories

- One year Parts only

### Residential Installation

- All commercial machines installed in residential applications have one year Parts warranty

# Water Filtration System



- Buy a new Ice-O-Matic IFQ Series Water Filtration System with a new CIM Series™ Cube Ice Maker, replace the filter cartridge every six months and Ice-O-Matic will extend the limited cuber evaporator warranty to seven years Parts.
- New ice maker and filter must be installed at the same time.
- Must register both the ice maker and water filter online at [iceomatic.com/warranty](http://iceomatic.com/warranty) within five days of installation.
- Water filter cartridge model number and serial number must be included with registration information.
- Water filter changes must be recorded at **iceomatic.com** every six months or less.
- Program is available with all Ice-O-Matic filter systems.
- Replacement cartridge must be an Ice-O-Matic replacement cartridge IOMQ (*See sizing chart for cartridge requirements*).
- Available in the U.S.A. and Canada only.

## Terms and Conditions

- List prices are F.O.B. Denver, Colorado.
- This price book supersedes all previous price books.
- Specifications and prices are subject to change without notice.
- All units tested per 810 and 820 AHRI standards based on 90° F air and 70° F water.
- All height dimensions of bins and ice makers with built-in storage include the height of the legs where applicable.
- For a full listing of Terms and Conditions, visit the “Compliance and Supply Chain” link at: **[iceomatic.com/supply-chain](http://iceomatic.com/supply-chain)**.





# The best for your business.

Some people may not realize it, but ice is a type of food. It's also a key ingredient in most foodservice applications around the world. That's why it's very important to select the right type of ice and ice machine for your business.

When choosing a machine, there are several factors that need to be considered, including ice type, machine location, sizing/ice amount and condenser style.





# Model Number Guide

## Elevation Series™ - Cube Ice

**CIM0330FA** CIM ..... Model CIM = Cube Ice Modular Series  
03 ..... Basic Family Size (lbs/24 hr): 03 = 300 lbs, 04 = 400 lbs, 10 = 1000 lbs plus  
3 ..... Width of machine in inches: 3 for 30", 2 for 22", 4 for 48"  
0 ..... Unit Electrical Characteristics: 0, 5, 6, 7 \*\*\*  
F ..... Cube Type: H = Half, F = Full, G = Grande  
A ..... Condenser Type: A = Air, W = Water, R = Remote

## UCG Series - Gourmet Ice Makers

**UCG060A** UCG ..... Undercounter Gourmet Series  
060 ..... Basic Family Size (lbs/24 hr): 06 = 60 lbs, 08 = 80 lbs, 10 = 100 lbs, 13 = 130 lbs  
0 ..... Unit Electrical Characteristics: 0, 5, 6, 7 \*\*\*  
G ..... Cube Type: G = Gourmet, GG = Gourmet Grande  
A ..... Condenser Type: A = Air Cooled

## Pearl Ice® & Flake Ice Makers

**GEM0956A** GEM ..... Model GEM = Modular Pearl Ice®, Model MFI = Modular Flake Ice Series  
095 ..... Basic Family Size (lbs/24 hr): Approximately 950 lbs  
6 ..... Unit Electrical Characteristics: 0, 5, 6, 7 \*\*\*  
A ..... A = Air Cooled, W = Water Cooled, R = Remote Condenser

## Remote Condensers

**RCA2061** RCA ..... RCA = Remote Condenser for cubers with a Headmaster  
RGA = Remote Condenser for pearl/flakers without a Headmaster  
20 ..... Coil Size  
6 ..... Unit Electrical Characteristics: 0 or 6  
1 ..... Number of Circuits

## Storage Bins

**B55** B ..... Model B = Bin  
55 ..... Approx. Size: 55 = 550-lb capacity

## Water Filter Systems

**IF14C** IF1 ..... Filter Type: IF1 = Ice-O-Matic Filter, inline type  
4 ..... Fitting Size: 4 = 1/4", 8 = 3/8"

**IFQ1** IFQ ..... Filter Type: IFQ = Ice-O-Matic Filtration System, IFQ Series  
1 ..... Number of Cartridges: 1 = Single, 2 = Double

\*\*\* Unit Electrical Characteristics

0 - 115/60/1 5 - 220-240/50/1 6 - 208-230/60/1 7 - 208-230/60/3



# Ice Forms & Series Guide

## GOURMET SERIES™ Cube Ice Series – Undercounters



### Gourmet (G)

(H) 1¼ in  
(Dia.) 1 in

GOURMET  
CUBE



### Gourmet Grande (GG)

(H) 1½ in  
(Dia.) 1½ in

GOURMET  
GRANDE  
CUBE

## PEARL Ice® Makers



### Pearl (P)

(H) ½ in  
(Dia.) ¾ in

PEARL  
ICE

## FLAKE Ice Makers



### Flake (F)

FLAKER  
ICE

## ELEVATION SERIES™ Cube Ice Makers - Modular



### Half (H)

(H) 7⁄8 in  
(W) ¾ in  
(D) 7⁄8 in

HALF  
CUBE



### Full (F)

(H) 7⁄8 in  
(W) 7⁄8 in  
(D) 7⁄8 in

FULL  
CUBE



### Grande (GR)

(H) 1½ in  
(W) 1¼ in  
(D) 7⁄8 in

GRANDE  
CUBE

## ICE SERIES™ Cube Ice Makers & Undercounters



### Half (H)

(H) 7⁄8 in  
(W) ¾ in  
(D) 7⁄8 in

HALF  
CUBE



### Full (F)

(H) 7⁄8 in  
(W) 7⁄8 in  
(D) 7⁄8 in

FULL  
CUBE



# We make it easy.

**Buying an ice machine doesn't have to be a challenge.**

Determining production requirements and the type of ice you need is a good first step and will help make the process a little easier.



ice  
is  
food.



## UCG Series™ - Undercounters



| Model Number | Machine Height<br>Standard/Short<br>Leg (in)** | Ice Production<br>lbs/24 hr@90°F<br>Air/70°F Water | Ice Production<br>lbs/24 hr@70°F<br>Air/50°F Water | Bin Storage<br>(lbs) | Condensing<br>Unit | Voltage<br>Units | Ship Weight<br>(lbs) |
|--------------|--|--|--|----------------------|--------------------|------------------|----------------------|
| UCG060A      | 30.25-32 /<br>27.375-27.75                     | 45   | 63   | 17.5                 | Air                | 115/60/1         | 81.5                 |

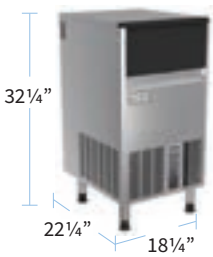

| Model Number | Machine Height<br>Standard/Short<br>Leg (in)** | Ice Production<br>lbs/24 hr@90°F<br>Air/70°F Water | Ice Production<br>lbs/24 hr@70°F<br>Air/50°F Water | Bin Storage<br>(lbs) | Condensing<br>Unit | Voltage<br>Units | Ship Weight<br>(lbs) |
|--------------|--|--|--|----------------------|--------------------|------------------|----------------------|
| UCG080A      | 32.25-34 /<br>29.375-29.75                     | 77.8   | 95   | 33                   | Air                | 115/60/1         | 81.5                 |

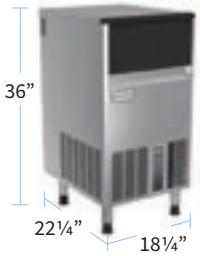

| Model Number | Machine Height<br>Standard/Short<br>Leg (in)** | Ice Production<br>lbs/24 hr@90°F<br>Air/70°F Water | Ice Production<br>lbs/24 hr@70°F<br>Air/50°F Water | Bin Storage<br>(lbs) | Condensing<br>Unit | Voltage<br>Units | Ship Weight<br>(lbs) |
|--------------|--|--|--|----------------------|--------------------|------------------|----------------------|
| UCG100A      | 36-37.75 /<br>33.125-33.5                      | 91.7   | 114  | 48.5                 | Air                | 115/60/1         | 97                   |
| UCG130A      |  | 114.3  | 121  |                      |                    |                  |                      |
| UCG130GA*    |  | 100.5  | 121  |                      |                    |                  |                      |

\* GOURMET GRANDE Ice Option

\*\* ADA compliant with short leg add-on

## UCG Series™ - Accessories

| Model Number | Description   | Ship Weight (lbs) |
|--------------|---|-------------------|
| 1011411-87   | True Undercounter Leg for UCG100, UCG130 and UCG130GA | 4                 |



# The choice is clear.

Our self-contained gourmet cube ice makers are designed with many practical features that make them reliable and carefree to operate. With durable stainless steel top panels and convenient slide-away doors, the self-contained models are perfect for bars, wait stations and undercounter applications.





## ICE Series™ - Undercounters

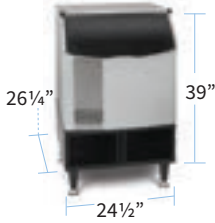

| Model Number | Ice Production<br>lbs/24 hr @ 90°F<br>Air/70°F Water | Ice Production<br>lbs/24 hr @ 70°F<br>Air/50°F Water | Half or<br>Full Cube | Bin Storage<br>(lbs) | Condensing<br>Unit | Voltage Units | Ship Weight<br>(lbs) |
|--------------|--|--|----------------------|----------------------|--------------------|---------------|----------------------|
| ICEU150A     | 165  | 238  | H/F                  | 74                   | Air                | 115/60/1      | 160                  |
| ICEU150W     | 193  | 251  |                      |                      | Water              | 115/60/1      |                      |
| ICEU220A     | 165  | 238  |                      |                      | Air                | 115/60/1      |                      |
| ICEU220W     | 193  | 251  |                      |                      | Water              | 115/60/1      |                      |
| ICEU226A     | 166  | 241  |                      |                      | Air                | 208-230/60/1  |                      |
| ICEU226W     | 174  | 232  |                      |                      | Water              | 208-230/60/1  |                      |



| Model Number | Ice Production<br>lbs/24 hr @ 90°F<br>Air/70°F Water | Ice Production<br>lbs/24 hr @ 70°F<br>Air/50°F Water | Half<br>Cube | Bin Storage<br>(lbs) | Condensing<br>Unit | Voltage Units | Ship<br>Weight<br>(lbs) |
|--------------|--|--|--------------|----------------------|--------------------|---------------|-------------------------|
| ICEU300A     | 1125   | 309  | H/F          | 112                  | Air                | 115/60/1      | 206                     |

## ICE Series™ - Ice Makers Bin Thermostat Kit Included

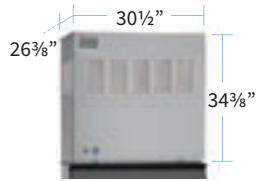

| Model Number | Ice Production<br>lbs/24 hr @ 90°F<br>Air/70°F Water | Ice Production<br>lbs/24 hr @ 70°F<br>Air/50°F Water | Half<br>Cube | Condensing<br>Unit | Voltage Units | Ship Weight (lbs) |
|--------------|--|--|--------------|--------------------|---------------|-------------------|
| ICE1506T*    | 1125   | 1430   | H            | Air                | 208-230/60/1  | 310               |

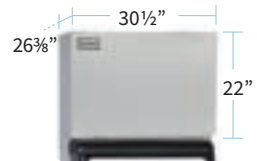

| Model Number | Ice Production<br>lbs/24 hr @ 90°F<br>Air/70°F Water | Ice Production<br>lbs/24 hr @ 70°F<br>Air/50°F Water | Half<br>Cube | Condensing<br>Unit | Voltage Units | Ship Weight (lbs) |
|--------------|--|--|--------------|--------------------|---------------|-------------------|
| ICE1506R**   | 1100   | 1450   | H            | Remote             | 208-230/60/1  | 310               |

\* Exclusive top-air discharge feature available at no extra charge.

\*\* Remote condensers and line sets are required for remote-cooled ice makers.

See Page 24 for RCA/RGA Series Remote Condensers.

## ICE Series™ - Accessories

| Model Number | Description  | Ship Weight (lbs) |
|--------------|--|-------------------|
| BPF-1        | Filler Panel Kit for 30" ICE Series™ Cube Ice Makers for <b>B110 bins only</b> | 8                 |
| KBT5         | Bin Top for 30" ICE1506 family for <b>B100 only</b>                            | 30                |
| KCUBEDISP    | Bin-level kit for Cornelius and Lancer dispensers with 30" ICE1506             | 1                 |
| KBTF21506    | Bin Top for (2) ICE1506's on <b>60" bins only</b>                              | 43                |



# The industry standard.

It's that familiar clinking sound in your favorite beverage. It's the fresh, crystal-clear ice that tumbles into glasses at restaurants, bars and convenience stores around the world, cooling the drink while preserving the flavor. Our widely popular cube ice never goes out of style and is perfect for any application or occasion. Long-lasting cube ice is the right choice for a wide variety of uses.

ice  
is  
food.



### **SEALED FOOD ZONE**

Unparalleled food safety. The only ice maker in the industry with a sealed food zone.

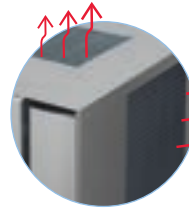

### **DUAL EXHAUST**

Groundbreaking technology allows hot-air discharge from the side or the top of every unit for the ultimate in flexibility.



### **SNAP IN AND OUT PLASTIC PARTS**

Sanitation has never been easier. Parts snap in and out and are dishwasher safe, no bottle brushes or tools required.



### **STANDARD AIR FILTER**

Cleaning made easy, removable and washable filter comes standard on Elevation Series machines.



### **ONE-TOUCH CLEANING**

One touch to sanitize, one touch to de-lime. LEDs signal when cleaning is required.

# The Elevation Series.

## SIMPLY THE CLEANEST ICE MACHINES

Our new and ground breaking Elevation Series is designed to simplify life. Our cube ice machines are easy to clean, easy to service, simple to operate, and environmentally responsible without sacrificing productivity. The Elevation Series provides clean, dependable ice from an astonishingly user-friendly and energy-efficient machine designed to work as hard as you. We believe design simplicity equals operational excellence, and innovation goes beyond just adding bells and whistles.

ice  
is  
food.







# Elevation Series™

## Modular Ice Makers



| Model Number | Ice Production<br>lbs/24 hr @ 90°F<br>Air / 70°F Water | Ice Production<br>lbs/24 hr @ 70°F<br>Air / 50°F Water | Half or<br>Full<br>Cube | Condensing<br>Unit | Voltage<br>Units | Ship<br>Weight<br>(lbs) |
|--------------|--|--|-------------------------|--------------------|------------------|-------------------------|
| CIM0320A     | 244  | 313  | H/F                     | Air                | 115/60/1         | 150                     |
| CIM0320W     | 274  | 316  |                         | Water              | 115/60/1         | 150                     |
| CIM0326A     | 236  | 330  |                         | Air                | 208-<br>230/60/1 | 150                     |
| CIM0520A     | 432  | 561  |                         | Air                | 115/60/1         | 165                     |
| CIM0520W     | 533  | 586  |                         | Water              | 115/60/1         | 175                     |
| CIM0526A     | 419  | 555  |                         | Air                | 208-<br>230/60/1 | 165                     |



| Model Number | Ice Production<br>lbs/24 hr @ 90°F<br>Air / 70°F Water | Ice Production<br>lbs/24 hr @ 70°F<br>Air / 50°F Water | Half or<br>Full<br>Cube | Condensing<br>Unit | Voltage<br>Units | Ship<br>Weight<br>(lbs) |
|--------------|--|--|-------------------------|--------------------|------------------|-------------------------|
| CIM0826A     | 711  | 896  | H/F                     | Air                | 208-<br>230/60/1 | 230                     |
| CIM0826W     | 774  | 896  |                         | Water              |                  | 230                     |
| CIM0826R*    | 793  | 906  |                         | Remote             |                  | 220                     |
| CIM1126A     | 762  | 932  |                         | Air                |                  | 230                     |
| CIM1126W     | 851  | 968  |                         | Water              |                  | 240                     |
| CIM1126R*    | 830  | 968  |                         | Remote             |                  | 215                     |



| Model Number | Ice Production<br>lbs/24 hr @ 90°F<br>Air / 70°F Water | Ice Production<br>lbs/24 hr @ 70°F<br>Air / 50°F Water | Half or<br>Full<br>Cube | Condensing<br>Unit | Voltage<br>Units | Ship<br>Weight<br>(lbs) |
|--------------|--|--|-------------------------|--------------------|------------------|-------------------------|
| CIM0330A     | 224  | 313  | H/F                     | Air                | 115/60/1         | 145                     |
| CIM0330W     | 265  | 316  |                         | Water              | 115/60/1         | 145                     |
| CIM0430A     | 310  | 435  |                         | Air                | 115/60/1         | 155                     |
| CIM0430W     | 365  | 460  |                         | Water              | 115/60/1         | 155                     |
| CIM0436A     | 340  | 465  |                         | Air                | 208-<br>230/60/1 | 155                     |
| CIM0436W     | 405  | 500  |                         | Water              | 208-<br>230/60/1 | 155                     |
| CIM0530A     | 420  | 561  |                         | Air                | 115/60/1         | 155                     |
| CIM0530W     | 470  | 586  |                         | Water              | 115/60/1         | 155                     |
| CIM0530R*    | 405  | 525  |                         | Remote             | 115/60/1         | 160                     |
| CIM0636A     | 440  | 600  |                         | Air                | 208-<br>230/60/1 | 160                     |
| CIM0636W     | 535  | 620  |                         | Water              | 208-<br>230/60/1 | 160                     |
| CIM0636R*    | 520  | 615  |                         | Remote             | 208-<br>230/60/1 | 160                     |

Qualifies for Energy Star

\* See Page 24 for RCA/RGA Series Remote Condensers.



# Elevation Series™

Modular Ice Makers



| Model Number | Ice Production<br>lbs/24 hr @ 90°F<br>Air/70°F Water | Ice Production<br>lbs/24 hr @ 70°F<br>Air/50°F Water | Half/Full/<br>Grande Cube | Condensing<br>Unit | Voltage Units | Ship<br>Weight<br>(lbs) |
|--------------|--|--|---------------------------|--------------------|---------------|-------------------------|
| CIM0836A     | 668  | 896  | H/F                       | Air                | 208-230/60/1  | 220                     |
| CIM0836W     | 798  | 896  | H/F                       | Water              | 208-230/60/1  | 210                     |
| CIM0836R*    | 769  | 906  | H/F                       | Remote             | 208-230/60/1  | 220                     |
| CIM0836GA**  | 645  | 800  | GR                        | Air                | 208-230/60/1  | 230                     |
| CIM1136A     | 739  | 932  | H/F                       | Air                | 208-230/60/1  | 220                     |
| CIM1136W     | 896  | 968  | H/F                       | Water              | 208-230/60/1  | 225                     |
| CIM1136R*    | 855  | 968  | H/F                       | Remote             | 208-230/60/1  | 235                     |
| CIM1137A     | 735  | 917  | H/F                       | Air                | 208-230/60/3  | 220                     |
| CIM1137W     | 870  | 944  | H/F                       | Water              | 208-230/60/3  | 225                     |
| CIM1137R*    | 830  | 973  | H/F                       | Remote             | 208-230/60/3  | 235                     |

\* See Page 24 for RCA/RGA Series Remote Condensers.

\*\* Grande Cube



| Model Number | Ice Production<br>lbs/24 hr @ 90°F<br>Air/70°F Water | Ice Production<br>lbs/24 hr @ 70°F<br>Air/50°F Water | Half/Full<br>Cube | Condensing<br>Unit | Voltage Units | Ship<br>Weight<br>(lbs) |
|--------------|--|--|-------------------|--------------------|---------------|-------------------------|
| CIM1446A     | 1174   | 1600   | H/F               | Air                | 208-230/60/1  | 310                     |
| CIM1446W     | 1397   | 1560   |                   | Water              | 208-230/60/1  | 300                     |
| CIM1446R*    | 1300   | 1650   |                   | Remote             | 208-230/60/1  | 280                     |
| CIM1447A     | 1174   | 1550   |                   | Air                | 208-230/60/3  | 310                     |
| CIM1447W     | 1397   | 1565   |                   | Water              | 208-230/60/3  | 300                     |
| CIM1447R*    | 1290   | 1625   |                   | Remote             | 208-230/60/3  | 280                     |
| CIM2046W     | 1690   | 1860   |                   | Water              | 208-230/60/1  | 335                     |
| CIM2046R*    | 1533   | 1830   |                   | Remote             | 208-230/60/1  | 335                     |
| CIM2047W     | 1639   | 1860   |                   | Water              | 208-230/60/3  | 325                     |
| CIM2047R*    | 1533   | 1830   |                   | Remote             | 208-230/60/3  | 335                     |

\* See Page 24 for RCA/RGA Series Remote Condensers.

All CIM Air Condensing models may be specific for a Top Air Discharge Only. Top Air Only units ship from factory with solid, non-louvered side panels, allowing for unique design solutions. Add a "T" to the end of any CIM Air Condensing unit to specify top air in your order. For Example: CIM330HAT





| Model Number | Description   | Ship Weight (lbs) |
|--------------|---|-------------------|
| BPF-1        | Filler Panel Kit with 30" CIM and ICE Series™ Cube Ice Makers for <b>B110 bins only</b>                     | 8                 |
| KBT5         | Bin Top for 30" CIM and ICE Series Cube Ice Makers including the ICE1506 family for <b>B100 bin</b>         | 30                |
| KBT23        | Bin Top for (1) 22" CIM Series Ice Makers on a <b>B110 bin</b>  | 22                |
| KBT222       | Bin Top for (2) 22" CIM Series Ice Makers on a <b>B110 bin</b>  | 33                |
| KCFS9-22*    | Mounting kit for Coca-Cola Freestyle 9000 with 22" CIM Series Ice Cube Makers                               | 5                 |
| KCFS91-22*   | Mounting kit for Coca-Cola™ Freestyle 9100 with 22" CIM Series Ice Cube Makers                              | 5                 |
| KCFS71-30    | Mounting kit for Coca-Cola™ Freestyle 7000/7100 with 30" CIM Series Ice Cube Makers                         | 5                 |
| KCFS9-30*    | Mounting kit for Coca-Cola™ Freestyle 9000 with 30" CIM Series Ice Cube Makers                              | 10                |
| KCFS91-30*   | Mounting kit for Coca-Cola™ Freestyle 9100 with 30" CIM Series Ice Cube Makers                              | 5                 |
| KCUBEDISP    | Bin-level kit for Cornelius and Lancer dispensers with all CIM Series including the ICE1506 Ice Cube Makers | 1                 |

\* Adapter from Coca-Cola™ also required.

## Elevation Series™ Safelce Sanitation System

| Model Number | Description  | Ship Weight (lbs) |
|--------------|--|-------------------|
| CIM0330AS    |  <p><b>Safelce is an add-on option for new CIM machines. Safelce generates a reactive oxygen mixture which binds to and destroys microbes on contact. Safelce kills Coronavirus, Flu, Odors, Mold and other biological contaminants, increasing the machine's expected lifespan by up to 30%. Safelce is a simple, low-maintenance design with easy annual bulb replacement.</b></p> <p><b>KSI-1 Upgrade Kit</b><br/>Sold Separately for Field Install</p> | 147               |
| CIM0430AS    |  | 157               |
| CIM0436AS    |  | 157               |
| CIM0530AS    |  | 157               |
| CIM0530RS    |  | 162               |
| CIM0636AS    |  | 162               |
| CIM0636RS    |  | 162               |
| CIM0836AS    |  | 222               |
| CIM0836RS    |  | 222               |
| CIM0836GAS*  |  | 232               |
| CIM1136AS    |  | 222               |
| CIM1136RS    |  | 237               |
| CIM1446AS    |  | 312               |
| CIM1446RS    |  | 282               |
| CIM2046RS    |  | 337               |

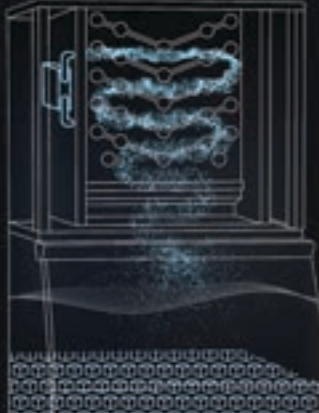
\* Grande Cube

**Safelce**  
Destroys COVID-19, bacteria, mold, odors, viruses, and other biological contaminants in seconds.



# FoodZone Disassembly and Cleaning

Incorporate FoodZone disassembly into your daily cleaning procedure for maximum machine uptime and food cleanliness



Loosen the two screws on the bottom of the front panel.



Remove the top plastic cover.



Remove the water hose.



Remove the evaporator splash plate.



Remove the distribution tube, depressing both side tabs.



Completely disassemble the distribution tube.



Swing up and depress the curtain's tabs to remove.



Remove the water reservoir by sliding out, down, and out.



All food zone parts are high temp dishwasher safe.





design tip  
twins on  
a bin

Run both air-cooled heads during busy season and one during slow seasons. The possibilities are endless!

# Simplicity Elevated.

As the most advanced ice maker on the market, the new Elevation Series machines are easy to clean, easy to operate, easy to service and environmentally responsible without sacrificing productivity. Only from Ice-O-Matic, the leader in ice, pure and simple.



ice  
is  
food.



# Pearl Ice® Series

Modular  
Makers/Dispensers  
Accessories

## Pearl Ice® Series™ Modular Ice Makers

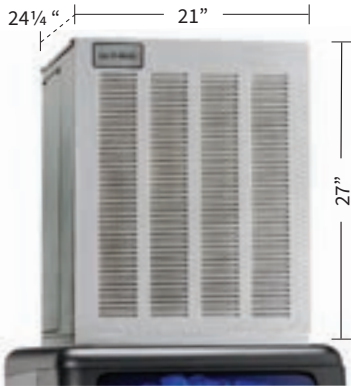

| Model Number | Ice Production<br>lbs / 24 hr @ 90°F<br>Air 70°F / Water | Ice Production<br>lbs / 24 hr @ 70°F<br>Air / 50°F Water | Condensing<br>Unit | Voltage Units | Ship Weight<br>(lbs) |
|--------------|--|--|--------------------|---------------|----------------------|
| GEM0450A     | 353  | 464  | Air                | 115/60/1      | 150                  |
| GEM0450W     | 429  | 508  | Water              | 115/60/1      | 150                  |
| GEM0650A     | 500  | 740  | Air                | 115/60/1      | 150                  |
| GEM0650W     | 633  | 770  | Water              | 115/60/1      | 165                  |
| GEM0650R*    | 550  | 770  | Remote             | 115/60/1      | 175                  |
| GEM0956A     | 753  | 1053   | Air                | 208-230/60/1  | 165                  |
| GEM0956W     | 877  | 1053   | Water              | 208-230/60/1  | 220                  |
| GEM0956R*    | 820  | 1011   | Remote             | 208-230/60/1  | 230                  |
| GEM1306A     | 1000   | 1350   | Air                | 208-230/60/1  | 220                  |
| GEM1306R*    | 1000   | 1350   | Remote             | 208-230/60/1  | 240                  |

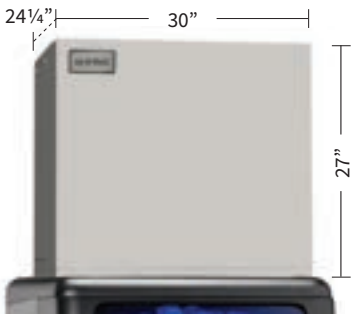

| Model Number | Ice Production<br>lbs / 24 hr @ 90°F<br>Air / 70°F Water | Ice Production<br>lbs / 24 hr @ 70°F<br>Air / 50°F Water | Condensing<br>Unit | Voltage Units | Ship Weight<br>(lbs) |
|--------------|--|--|--------------------|---------------|----------------------|
| GEM2006R*    | 1635   | 1960   | Remote             | 208-230/60/1  | 316                  |
| GEM2006W     | 1820   | 2225   | Water              |               |                      |

Qualifies for Energy Star

\* See Page 24 for RCA/RGA Series Remote Condensers.

## Pearl Ice® Series™ Accessories

| Model Number | Description   | Ship Weight (lbs) |
|--------------|---|-------------------|
| BPF-1        | Filler Panel Kit with 30" GEM Series Ice® Makers for <b>B110 bins only</b>  | 8                 |
| KBT5         | Bin Top for 30" GEM Series Ice® Makers on a B100 bin  | 30                |
| KBT19        | Bin Top for 21" GEM Series Ice® Makers on a 30" bin   | 22                |
| KBT222       | Bin Top for (2) GEM Series Ice® Makers on a B110 bin  | 33                |
| KBT23        | Bin Top for (1) GEM Series Ice® Makers on a B110 bin  | 33                |
| KBT24        | Bin Top for (1) GEM Series Ice® Makers on a 22" bin   | 10                |
| KGEMDISP     | Kit required when mounting GEM Series Ice® Makers to beverage dispenser (Cornelius and Lancer)  | 1                 |
| KGEMFS       | Mounting and bin level ice control kit, required for installation of 21" GEM Series Ice® Makers on Coca-Cola™ Freestyle dispenser model 9000. Requires Coke Adapter to match Freestyle dispenser color. | 5                 |
| KFS7-G       | Ice Control Kit, required for installation of 21" GEM Series Ice® Makers on a Coca-Cola™ Freestyle dispensers model 7000.   | 5                 |
| KBTF230      | Bin Kit for (2) 30" GEM Series Ice® Makers on 60" bins only   | 1                 |



# Pearl Ice® Series

Modular  
Makers/Dispensers  
Accessories

## Pearl Ice® Series™ –Ice/Water Dispenser

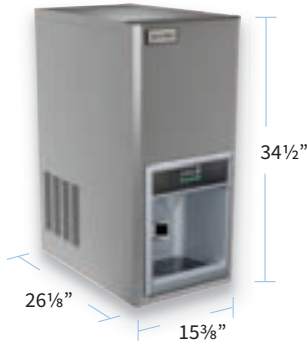

| Model Number | Ice Production<br>lbs/24 hr @ 90°F<br>Air/70°F Water | Ice Production<br>lbs/24 hr @ 70°F<br>Air/50°F Water | Pearl Ice | Bin Storage<br>(lbs) | Condensing Unit | Voltage Units | Ship Weight<br>(lbs) |
|--------------|--|--|-----------|----------------------|-----------------|---------------|----------------------|
| GEMD270A2    | 198  | 273  | P         | 12                   | Air             | 115/60/1      | 161                  |

## Pearl Ice® Series™ –Undercounter Ice Maker

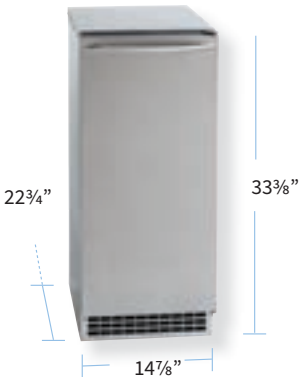

| Model Number | Ice Production<br>lbs/24 hr @ 90°F<br>Air/70°F Water | Ice Production<br>lbs/24 hr @ 70°F<br>Air/50°F Water | Pearl Ice | Bin Storage<br>(lbs) | Condensing Unit | Voltage Units | Ship Weight<br>(lbs) |
|--------------|--|--|-----------|----------------------|-----------------|---------------|----------------------|
| GEMU090*     | 60   | 85   | P         | 22                   | Air             | 115/60/1      | 133                  |

\* Unit includes cord sets



## Pearl Ice® Series™ –Ice Maker & Ice Water Dispenser Accessories

| Model Number | Description          | Ship Weight (lbs) |
|--------------|----------------------|-------------------|
| KPU090       | Pump kit for GEMU090 | 7                 |



# A consumer favorite.

It's a soft, chewable ice that absorbs the flavor of a beverage for more enjoyable chewing. This ice dispenses well, blends quickly and displaces liquid better than cubes. It's a great choice for restaurants, convenience stores and is ideal for use in buffets, grocery stores, fish markets, chilled food displays and it packs well for healthcare applications.





# Flake Ice Series

Modular  
Makers/Dispensers  
Accessories

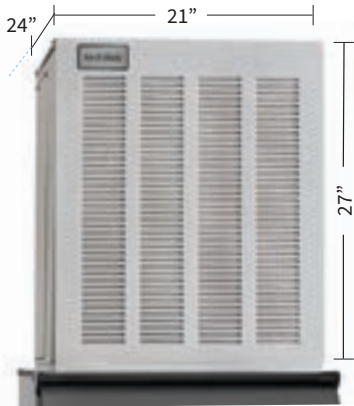
## Flake Ice Series Modular Ice Makers



| Model Number   | Ice Production<br>lbs / 24 hr @ 90°F Air/<br>70°F Water | Ice Production<br>lbs / 24 hr @ 70°F Air/<br>50°F Water | Condensing<br>Unit | Voltage<br>Units | Ship Weight<br>(lbs) |
|--|---|---|--------------------|------------------|----------------------|
| MFI0500A   | 370   | 540   | Air                | 115/60/1         | 205                  |
| MFI0500W   | 456   | 541   | Water              | 115/60/1         | 205                  |
| MFI0800A   | 615   | 900   | Air                | 115/60/1         | 200                  |
| MFI0800W   | 740   | 940   | Water              | 115/60/1         | 200                  |
| MFI0800R*  | 650   | 925   | Remote             | 115/60/1         | 200                  |
|  MFI1256A | 885   | 1149  | Air                | 208-<br>230/60/1 | 215                  |
| MFI1256W   | 959   | 1137  | Water              | 208-<br>230/60/1 | 210                  |
| MFI1256R*  | 950   | 1040  | Remote             | 208-<br>230/60/1 | 230                  |
|  MFI1506A | 1050  | 1450  | Air                | 208-<br>230/60/1 | 290                  |
| MFI1506R*  | 1025  | 1390  | Remote             | 208-<br>230/60/1 | 290                  |

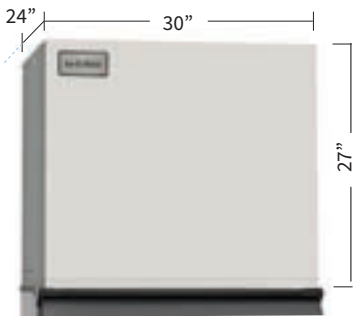

| Model Number  | Ice Production<br>lbs / 24 hr @ 90°F Air/<br>70°F Water | Ice Production<br>lbs / 24 hr @ 70°F Air/<br>50°F Water | Condensing<br>Unit | Voltage Units | Ship Weight<br>(lbs) |
|---|---|---|--------------------|---------------|----------------------|
|  MFI2306R* | 1845  | 2250  | Remote             | 208-230/60/1  | 316                  |
| MFI2306W*   | 2100  | 2600  | Water              |               |                      |

\* See Page 24 for RCA/RGA Series Remote Condensers.

## Flake Ice Series Accessories

| Model Number | Description   | Ship Weight (lbs) |
|--------------|---|-------------------|
| BPF-1        | Filler Panel Kit with 30" MFI Series Ice Makers for <b>B110 bins only</b>   | 8                 |
| KBT5         | Bin Top for 30" MFI Series Ice Makers on a B100 bin   | 30                |
| KBT19        | Bin Top for 21" MFI Series Ice Makers on a 30" bin  | 22                |
| KBT222       | Bin Top for (2) MFI Series Ice Makers on a B110 bin   | 33                |
| KBT23        | Bin Top for (1) MFI Series Ice Makers on a B110 bin   | 33                |
| KBT24        | Bin Top for (1) MFI Series Ice Makers on a 22" bin  | 10                |
| KGEMDISP     | Kit required when mounting MFI to beverage dispenser (Cornelius and Lancer)   | 1                 |
| KGEMFS       | Mounting and bin level ice control kit, required for installation of 21" MFI Series Ice Makers on Coca-Cola™ Freestyle dispenser model 9000.<br>Requires Coke Adapter to match Freestyle dispenser color. | 5                 |
| KFST-G       | Ice Control Kit, required for installation of 21" MFI Series Ice Makers on a Coca-Cola™ Freestyle dispensers model 7000.  | 5                 |
| KBTF230      | Bin Kit for (2) 30" MFI Series Ice Makers on 60" bins only  | 1                 |





# Perfect for presentation.

Our flake ice is ideal for both the presentation and preservation of perishable food items. Ice-O-Matic flake ice extends the shelf life and appearance of seafood, fresh fruits and vegetables for fresher displays that help increase sales. Flake ice is also ideal for use in bakeries, perishable food transport and health care applications.

ice  
is  
food.



## Remote Condensers

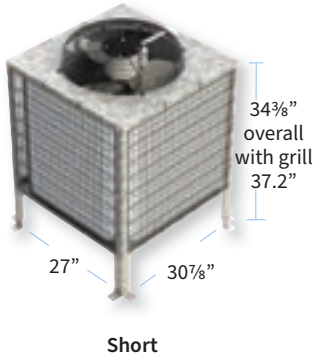

| Model Number | Description   | Height | Voltage Units | Ship Weight (lbs) |
|--------------|---|--------|---------------|-------------------|
| RCA1001      | Remote Condenser for CIM0530R   | Short  | 115/60/1      | 97                |
| RCA1061      | Remote Condenser for model CIM0636R   | Short  | 208-230/60/1  | 97                |
| RCA2061      | Remote Condenser for models CIM0826R, CIM0836R, CIM1126R, CIM1136R, GEM2006R and MFI2306R | Tall   | 208-230/60/1  | 111               |
| RCA3061      | Remote Condenser for model CIM1446R and ICE1506R  | Short  | 208-230/60/1  | 119               |
| RCA3561      | Remote Condenser for model CIM2046R   | Tall   | 208-230/60/1  | 115               |

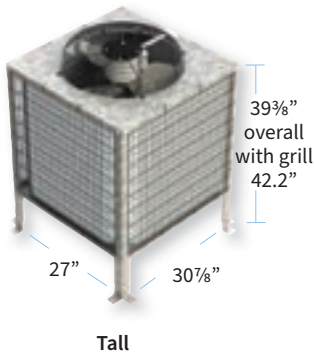

| Model Number | Description   | Height | Voltage Units | Ship Weight (lbs) |
|--------------|---|--------|---------------|-------------------|
| RGA0501-HM*  | Remote Condenser for models GEM0650R, MFI0800R                    | Short  | 115/60/1      | 97                |
| RGA1061-HM*  | Remote Condenser for model GEM0956R, GEM1306R, MFI1506R, MFI1256R | Short  | 208-230/60/1  | 97                |

\* Does not include Headmaster

## Remote Condenser Accessories

| Model Number | Description  | Ship Weight (lbs) |
|--------------|--|-------------------|
| RT325404     | 25 ft. Precharged Tubing Kit for units using R-404A refrigerant                        | 13                |
| RT340404     | 40 ft. Precharged Tubing Kit for units using R-404A refrigerant                        | 18                |
| RT375404     | 75 ft. Precharged Tubing Kit for units using R-404A refrigerant                        | 36                |
| GRILL10      | Optional Grill Guard Kit for RCA-1001, RCA-1061, RCA-3061, RGA-0501-HM and RGA-1061-HM | 8                 |
| GRILL20      | Optional Grill Guard Kit for RCA-2061 and RCA-3561                                     | 12                |



# Discover the difference.

The Ice-O-Matic difference means customers receive American made purity, simplicity, productivity and reliability. Every time.



ice  
is  
food.



# Dispensers

Countertop Dispensers  
Hotel Dispensers

## Countertop Cube/Pearl Ice Dispensers



| Model Number | Dispenser Operation | Bin Storage (lbs) | Voltage Units | Ship Weight (lbs) |
|--------------|---------------------|-------------------|---------------|-------------------|
| IOD150*      | Cup Activated       | 150               | 115/60/1      | 139               |

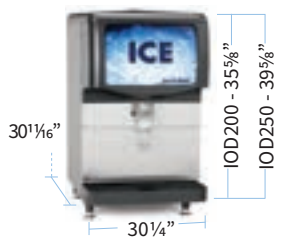

| Model Number | Dispenser Operation | Bin Storage (lbs) | Voltage Units | Ship Weight (lbs) |
|--------------|---------------------|-------------------|---------------|-------------------|
| IOD200**     | Cup Activated       | 200               | 115/60/1      | 193               |
| IOD250**     |                     | 250               |               | 197               |

## Hotel Cube Ice Dispensers



| Model Number | Dispenser Operation | Bin Storage (lbs) | Voltage Units | Ship Weight (lbs) |
|--------------|---------------------|-------------------|---------------|-------------------|
| CD40022*     | Push Activated      | 120               | 115/60/1      | 230               |



| Model Number                                    | Dispenser Operation     | Bin Storage (lbs) | Voltage Units | Ship Weight (lbs) |
|---|-------------------------|-------------------|---------------|-------------------|
| CD40030**                                       | Push Activated          | 180               | 115/60/1      | 220               |
| CD40130**<br>Water Glass Filler<br>Kit Included | Push & Cup<br>Activated |                   |               | 230               |

\* Accepts only 22" Machines  
\*\* Accepts only 30" Machines



## Ice Dispenser & Hotel Accessories

| Model Number | Description   | Ship Weight (lbs) |
|--------------|---|-------------------|
| KBT15022     | Adapter and bin-level kit for 22" cubers and nugget ice makers on IOD150  | 12                |
| KBT25030     | Adapter and bin-level kit for 30" cubers on IOD200/250  | 13                |
| KBT25022     | Adapter and bin-level kit for 22" cubers and nugget ice makers on IOD200/250  | 28                |
| KWGFID       | Water glass filler kit for IOD150/200/250 and CD40022 (Field installed only)  | 2                 |
| KGEMDISP     | Kit required when mounting GEM to beverage dispenser (Cornelius and Lancer)   | 1                 |
| KCUBEDISP*   | Bin-level kit for Cornelius and Lancer dispensers with 30" CIM Series Cube Ice Makers (Bin stat & deflector included)   | 1                 |
| KFS7-22*     | Mounting kit for Coca-Cola™ Freestyle 7000 & 7100 with 22" ICE Series Cube Ice Makers   | 9                 |
| KFS7-30*     | Mounting kit for Coca-Cola™ Freestyle 7000 & 7100 with 30" ICE Series Cube Ice Makers   | 10                |
| KCFS71-30*   | Mounting kit for Coca-Cola™ Freestyle 7000 & 7100 with 30" CIM Series Cube Ice Makers   | 7                 |
| KCFS9-22*    | Mounting kit for Coca-Cola™ Freestyle 9000 with 22" CIM Series Cube Ice Makers  | 5                 |
| KCFS91-22*   | Mounting kit for Coca-Cola™ Freestyle 9100 with 22" CIM Series Cube Ice Makers  | 5                 |
| KCFS91-30*   | Mounting kit for Coca-Cola™ Freestyle 9100 with 30" CIM Series Cube Ice Makers  | 14                |
| KCFS9-30*    | Mounting kit for Coca-Cola™ Freestyle 9000 with 30" CIM Series Cube Ice Makers  | 10                |
| KGEMFS*      | Mounting and bin level ice control kit, required for installation of 22" Pearl Ice Makers on Coca-Cola™ Freestyle dispenser model 9000. Requires Coca-Cola™ Adapter to match Freestyle dispenser (Red, Silver or Black) | 5                 |

\* Adapter from Coca-Cola™ also required.

## Dispenser Kits

| Model Number      | Style                           | CIM Series Cube Ice Makers |           | ICE Series Cube Ice Makers |           | GEM Series Ice Makers |          |
|-------------------|---------------------------------|----------------------------|-----------|----------------------------|-----------|-----------------------|----------|
|                   |                                 | 22" W                      | 30" W     | 22" W                      | 30" W     | 21" W                 | 30" W    |
| IOD150            | 22" Countertop Dispenser        | KBT15022                   | N/A       | KBT15022                   | N/A       | KBT15022              | N/A      |
| IOD200/250        | 30" Countertop Dispenser        | KBT25022                   | KBT25030  | KBT25022                   | KBT25030  | KBT25022              | KBT25030 |
| GENERIC DISPENSER | Lancer/Serv-end Etc.            | KCUBEDISP                  | KCUBEDISP | KCUBEDISP                  | KCUBEDISP | KGEMDISP              | KGEMDISP |
| CD40022           | 22" Hotel Dispenser             | ▲                          | N/A       | ▲                          | N/A       | N/A                   | N/A      |
| CD40030           | 30" Hotel Dispenser             | N/A                        | ▲         | N/A                        | ▲         | N/A                   | N/A      |
| FS7000            | 30" Countertop Coke Dispenser   | KCUBEDISP                  | KFS71-30  | KFS7-22                    | KFS7-30   | KFS7-G                | N/A      |
| FS7100            | 30" Countertop Coke Dispenser   | KCUBEDISP                  | KFS71-30  | KFS7-22                    | KFS7-30   | KFS7-G                | N/A      |
| FS9000            | 22" Freestanding Coke Dispenser | KCFS9-22                   | KCFS9-30  | KIBD-01                    | KIBD-30   | KGEMFS                | N/A      |
| FS9100            | 22" Freestanding Coke Dispenser | KCFS91-22                  | KCFS91-30 | KFS91-22                   | KIBD91-30 | KGEMDISP              | N/A      |
| PEPSI SPIRE       | 30" Countertop Pepsi Dispenser  | KCUBEDISP                  | KCUBEDISP | KCUBEDISP                  | KCUBEDISP | KGEMDISP              | KGEMDISP |

This information is subject to change. Please visit our website [www.iceomatic.com](http://www.iceomatic.com) for the most recently updated kit information.

▲ Kit not required

N/A - Ice Machine and Dispenser not applicable



# Storage Bins

Bins  
Adapters  
Accessories

## Storage Bins



| Model Number | Bin Storage (lbs) | Dimensions<br>W x D x H (in) | Ship Weight (lbs) |
|--------------|-------------------|------------------------------|-------------------|
| B25          | 242               | 30 x 31 x 28                 | 74                |
| B40          | 344               | 30 x 31 x 28                 | 103               |
| B42          | 351               | 22 x 31 x 50                 | 99                |
| B55          | 510               | 30 x 31 x 50                 | 125               |
| B110         | 854               | 48 x 31 x 50                 | 191               |



| Model Number | Bin Storage (lbs) | Dimensions<br>W x D x H (in) | Ship Weight (lbs) |
|--------------|-------------------|------------------------------|-------------------|
| B700-30      | 680               | 30 x 31 x 60                 | 212               |
| B1000-48     | 1000              | 48 x 31 x 56                 | 268               |
| B1300-48     | 1320              | 48 x 31 x 65                 | 270               |
| B1325-60     | 1325              | 60 x 31 x 56                 | 320               |
| B1600-60     | 1660              | 60 x 31 x 56                 | 340               |

## Bin Top Adapters

| Model Number | Description  | Ship Weight (lbs) |
|--------------|--|-------------------|
| KBT5         | Bin Top for 30" CIM and ICE Series Cuber including the ICE1506 family<br><b>for B100 only</b>        | 30                |
| KBT19        | Bin Kit for 22" CIM, MFI and GEM Series on a 30" bin   | 22                |
| KBT222       | Bin top for (2) 22" CIM, (2) MFI or (2) GEM Series on B110 bin                                       | 33                |
| KBT23        | Bin Kit for (1) 22" CIM, (1) GEM or (1) MFI Series on a B110 bin                                     | 33                |
| KBT24        | Bin Kit for (1) GEM or (1) MFI on a 22" bin  | 10                |
| KBTF230      | Bin Kit for (2) 30" CIM, GEM and MFI Series Cube Ice Makers<br><b>on 60" bins only</b>               | 43                |
| BPF-1        | Filler Panel Kit with 30" CIM, GEM, MFI and ICE Series™ Cube Ice Makers<br><b>for B110 bins only</b> | 8                 |

## Bin Accessories

| Model Number | Description      | Ship Weight (lbs) |
|--------------|------------------|-------------------|
| KLSCO        | 82 oz ice scoop* | 1                 |
| KSSCO        | 16 oz ice scoop* | 1                 |
| KSHOV        | Plastic shovel   | 3                 |
| KSHOB        | Bracket shovel   | 2                 |
| KICEP        | Plastic paddle   | 7                 |
| KPBRA        | Bracket paddle   | 2                 |

\* Ice scoop sold separately for B700-30, B1000-48, B1300-48, B1325-60 and B1600-60 models.



## Single Ice Machine Configurations

| Model Number | Style       | CIM Series Cube Ice Makers |          |       | ICE Series Cube Ice Makers |          |       | Pearl Ice® Ice Makers |          | Flake Ice Makers |          |
|--------------|-------------|----------------------------|----------|-------|----------------------------|----------|-------|-----------------------|----------|------------------|----------|
|              |             | 22" W                      | 30" W    | 48" W | 22" W                      | 30" W    | 48" W | 21" W                 | 30" W    | 21" W            | 30" W    |
| B25PP**      | Slope Front | KBT19                      | ▲        | N/A   | KBT19                      | ▲        | N/A   | KBT19                 | ▲        | KBT19            | ▲        |
| B40PS        | Slope Front | KBT19                      | ▲        | N/A   | KBT19                      | ▲        | N/A   | KBT19                 | ▲        | KBT19            | ▲        |
| B42PS        | Slope Front | ▲                          | N/A      | N/A   | ▲                          | N/A      | N/A   | KBT24                 | N/A      | KBT24            | N/A      |
| B55PS        | Slope Front | KBT19                      | ▲        | N/A   | KBT19                      | ▲        | N/A   | KBT19                 | ▲        | KBT19            | ▲        |
| B110PS       | Slope Front | KBT23                      | BPF-1*** | ▲     | KBT23                      | BPF-1*** | ▲     | KBT23                 | BPF-1*** | KBT23            | BPF-1*** |
| B700-30      | Upright     | ▲                          | ▲        | ▲     | ▲                          | ▲        | ▲     | ▲                     | ▲        | ▲                | ▲        |
| B1000-48     | Upright     | ▲                          | ▲        | ▲     | ▲                          | ▲        | ▲     | ▲                     | ▲        | ▲                | ▲        |
| B1300-48     | Upright     | ▲                          | ▲        | ▲     | ▲                          | ▲        | ▲     | ▲                     | ▲        | ▲                | ▲        |
| B1325-60     | Upright     | ▲                          | ▲        | ▲     | ▲                          | ▲        | ▲     | ▲                     | ▲        | ▲                | ▲        |
| B1600-60     | Upright     | ▲                          | ▲        | ▲     | ▲                          | ▲        | ▲     | ▲                     | ▲        | ▲                | ▲        |

\*\* Rotocast finish / \*\*\* BPF-1 used with B110 bins only. If you have an older model B100 use the KBT5.

▲ Kit not required / N/A - Ice Machine and Bin Configurator not applicable

## Side-By-Side Ice Machine Configurations

| Model Number | Style       | CIM Series Cube Ice Makers |           | ICE Series Cube Ice Makers |           | Pearl Ice® Ice Makers |           | Flake Ice Makers |           |
|--------------|-------------|----------------------------|-----------|----------------------------|-----------|-----------------------|-----------|------------------|-----------|
|              |             | 2 x 22" W                  | 2 x 30" W | 2 x 22" W                  | 2 x 30" W | 2 x 21" W             | 2 x 30" W | 2 x 21" W        | 2 x 30" W |
| B25PP**      | Slope Front | N/A                        | N/A       | N/A                        | N/A       | N/A                   | N/A       | N/A              | N/A       |
| B40PS        | Slope Front | N/A                        | N/A       | N/A                        | N/A       | N/A                   | N/A       | N/A              | N/A       |
| B42PS        | Slope Front | N/A                        | N/A       | N/A                        | N/A       | N/A                   | N/A       | N/A              | N/A       |
| B55PS        | Slope Front | N/A                        | N/A       | N/A                        | N/A       | N/A                   | N/A       | N/A              | N/A       |
| B110PS       | Slope Front | KBT222                     | N/A       | N/A                        | KBT222    | KBT222                | N/A       | KBT222           | N/A       |
| B700-30      | Upright     | N/A                        | N/A       | N/A                        | N/A       | N/A                   | N/A       | N/A              | N/A       |
| B1000-48     | Upright     | ▲▲                         | N/A       | ▲▲                         | N/A       | ▲▲                    | N/A       | ▲▲               | N/A       |
| B1300-48     | Upright     | ▲▲                         | N/A       | ▲▲                         | N/A       | ▲▲                    | N/A       | ▲▲               | N/A       |
| B1325-60     | Upright     | ▲▲                         | KBT230*   | ▲▲                         | KBTF21506 | ▲▲                    | KBT230*   | ▲▲               | KBT230*   |
| B1600-60     | Upright     | ▲▲                         | KBT230*   | ▲▲                         | KBTF21506 | ▲▲                    | KBT230*   | ▲▲               | KBT230*   |

\* Must use remote or water cooled model only / \*\* Rotocast finish

▲ Kit not required

N/A - Ice Machine and Bin Configurator not applicable

There are times when it is desirable to install (2) ice machines side-by-side on a bin. The reasons may range from gaining maximum output to creating redundancy. Ice-O-Matic offers an array of kits and bins with custom order tops for just such applications.



## Water Filtration Systems



### IFQ1-S

Single Filter

|                         |              |
|-------------------------|--------------|
| dimensions (in)         | 10.4 x 6 x 4 |
| flow rate max (gpm)     | .75          |
| pressure max (psi)      | 125          |
| max operating temp (°F) | 100          |
| micron rating           | 0.5          |
| ship weight (lbs)       | 2            |
| pack quantity           | N/A          |



### IFQ1

Single Filter

|                         |            |
|-------------------------|------------|
| dimensions (in)         | 15 x 6 x 4 |
| flow rate max (gpm)     | 1.5        |
| pressure max (psi)      | 125        |
| max operating temp (°F) | 100        |
| micron rating           | 0.5        |
| ship weight (lbs)       | 4          |
| pack quantity           | 10         |



### IFQ1-XL

Single Filter

|                         |            |
|-------------------------|------------|
| dimensions (in)         | 21 x 6 x 4 |
| flow rate max (gpm)     | 2.25       |
| pressure max (psi)      | 125        |
| max operating temp (°F) | 100        |
| micron rating           | 0.5        |
| ship weight (lbs)       | 5          |
| pack quantity           | N/A        |



### IFQ2

Dual Filter

|                         |                 |
|-------------------------|-----------------|
| dimensions (in)         | 16 x 10 x 7.125 |
| flow rate max (gpm)     | 3               |
| pressure max (psi)      | 125             |
| max operating temp (°F) | 100             |
| micron rating           | 0.5             |
| ship weight (lbs)       | 8               |
| pack quantity           | N/A             |



### IFQ2-XL

Dual Filter

|                         |                   |
|-------------------------|-------------------|
| dimensions (in)         | 23.21 x 13 x 4.65 |
| flow rate max (gpm)     | 4.5               |
| pressure max (psi)      | 125               |
| max operating temp (°F) | 100               |
| micron rating           | 0.5               |
| ship weight (lbs)       | 9                 |
| pack quantity           | N/A               |



### IF14C / IF18C

Single Inline Cartridge .25" Compression (IF14C) or .375" Compression (IF18C)

|                         |              |
|-------------------------|--------------|
| dimensions (in)         | 11.75 x 2.75 |
| flow rate max (gpm)     | 1.0          |
| pressure max (psi)      | 100          |
| max operating temp (°F) | 100          |
| micron rating           | 10           |
| ship weight (lbs)       | 2            |
| pack quantity           | 12           |





## IOM Replacement Cartridges

| Model Number | Description  | Pack Qty |
|--------------|--|----------|
| IOMQ-S       | Single quick twist replacement cartridge for IFQ1-S                                    | N/A      |
| IOMQ         | Single quick twist replacement cartridge for IFQ1 or IFQ2                              | 10       |
| IOMQ-XL      | Single quick twist replacement cartridge for IFQ1-XL                                   | N/A      |
| IOMWFRC      | Single replacement filter with male quick connect fittings for manifold filter systems | 10       |

## Filter Cartridge Features

- Inhibit the formation of scale
- Remove dirt and sediment
- Reduce chlorine, taste and odor

*Ice-O-Matic recommends the use of water filtration with all ice-making products.*

## Water Filtration Application Charts - CUBE

| Model Number  | ICEU070 | ICEU150<br>ICEU220<br>ICEU300 | CIM0320-<br>CIM0430 | CIM0520-<br>CIM0630 | CIM0826-<br>CIM1136 | CIM1446-<br>CIM1545 | CIM1845-<br>CIM2046 | ICE1506 | UCG080-<br>UCG130 |
|---------------|---------|-------------------------------|---------------------|---------------------|---------------------|---------------------|---------------------|---------|-------------------|
| IFQ1-S        | X       | X                             |                     |                     |                     |                     |                     |         | X                 |
| IFQ1          |         |                               | X                   |                     |                     |                     |                     |         |                   |
| IFQ1-XL       |         |                               |                     | X                   |                     |                     |                     |         |                   |
| IFQ2          |         |                               |                     |                     | X                   | X                   |                     | X       |                   |
| IFQ2-XL       |         |                               |                     |                     |                     |                     | X                   |         |                   |
| IFI4C / IF18C | X       | X                             |                     |                     |                     |                     |                     |         | X                 |

## Water Filtration Application Charts - PEARL & FLAKE

| Model Number  | GEMU090 | GEM0450-<br>GEM0650 | GEM0956 | GEM1306 | GEM2006 | MFI0500 | MFI0800-<br>MFI1256 | MFI1506 | MFI2306 |
|---------------|---------|---------------------|---------|---------|---------|---------|---------------------|---------|---------|
| IFQ1-S        | X       |                     |         |         |         | X       |                     |         |         |
| IFQ1          |         | X                   |         |         |         |         |                     |         |         |
| IFQ1-XL       |         |                     | X       |         |         |         | X                   |         |         |
| IFQ2          |         |                     |         | X       |         |         |                     | X       |         |
| IFQ2-XL       |         |                     |         |         | X       |         |                     |         | X       |
| IFI4C / IF18C | X       |                     |         |         |         | X       |                     |         |         |

# Pricing Details.

View our most current pricing structures. Ice-O-Matic's knowledgeable sales representatives can also answer any questions and walk you through the selection process.



## Contact Us.

### Sales and Customer Service

Whether you have a sales question, a support inquiry, or just need to hear a friendly voice our outstanding customer service is available for you.

Call Us: 1-800-423-3367

Online: [iceomatic.com/servicesupport](https://iceomatic.com/servicesupport)

Email Us: [customerservice@iceomatic.com](mailto:customerservice@iceomatic.com)

### Technical Support 24/7 Support

Our technical support center provides best-in-class service with decades of experience. Contact day or night with your most technical questions!

Call Us: 1-855-TECH-IOM

Online: [iceomatic.com/servicesupport](https://iceomatic.com/servicesupport)

Email Us: [techsupport@iceomatic.com](mailto:techsupport@iceomatic.com)

©2022 Ice-O-Matic. ® a Registered Trademark of Ice-O-Matic.

We reserve the right to make changes in design, specifications, and content at any time without obligation. AgION® antimicrobial is registered with EPA and is a trademark of AgION Technologies.

an Ali Group Company



The Spirit of Excellence



ice  
is  
food.

**Ice-O-Matic**   
Ice. Pure and Simple<sup>®</sup>

11100 East 45th Avenue | Denver, CO 80239  
866.PUREICE | [iceomatic.com](http://iceomatic.com)