

STANDARD FEATURES

- Stainless steel door(s) & louver
- Anodized aluminum sides & interior
- LED display control
- 115/60/1 voltage, self-contained, with cord & plug attached
- Bottom-mounted refrigeration system
- Self-closing door(s) with stay-open feature & lock(s)
- Magnetic snap-in door gasket(s)
- Gasket protecting retainer
- Magnetic proximity door switch
- Four 4" high casters with locks on front casters
- Three heavy duty epoxy coated shelves per section
- Three-year parts & labor warranty
- Five-year compressor warranty



CLBM-23R-HS-R



CLBM-49F-FS-LR

ONE SECTION SOLID DOOR REACH-IN MODELS

WIDTH x DEPTH x HEIGHT	DOOR HEIGHT	DOOR HINGING	REFRIGERATORS	FREEZERS
27" x 33.5" x 78"	Full	Right	CLBM-23R-FS-R	CLBM-23F-FS-R
	Full	Left	CLBM-23R-FS-L	CLBM-23F-FS-L
	Half	Right	CLBM-23R-HS-R	CLBM-23F-HS-R
	Half	Left	CLBM-23R-HS-L	CLBM-23F-HS-L

TWO SECTION SOLID DOOR REACH-IN MODELS

WIDTH x DEPTH x HEIGHT	DOOR HEIGHT	DOOR HINGING	REFRIGERATORS	FREEZERS
53.7" x 33.5" x 78"	Full	Left/Right	CLBM-49R-FS-LR	CLBM-49F-FS-LR
	Full	Right/Right	CLBM-49R-FS-RR	CLBM-49F-FS-RR
	Full	Left/Left	CLBM-49R-FS-LR	CLBM-49F-FS-LR
	Half	Left/Right	CLBM-49R-HS-LR	CLBM-49F-HS-LR
	Half	Right/Right	CLBM-49R-HS-RR	CLBM-49F-HS-RR
	Half	Left/Left	CLBM-49R-HS-LL	CLBM-49F-HS-LL

STANDARD FEATURES

- Stainless steel front & louver
- Anodized aluminum sides & interior
- Metal door handle(s)
- LED display control
- 115/60/1 Voltage, self-contained, with cord & plug attached
- Bottom-mounted refrigeration system
- Self-closing door(s) with stay-open feature
- Magnetic snap-in door gasket(s)
- Magnetic proximity door switch
- Four 4" high casters with locks on front casters
- Three heavy duty epoxy coated shelves per section
- Three-year parts & labor warranty
- Five-year compressor warranty



CLBM-23R-FG-R



CLBM-49F-FG-LR

ONE SECTION GLASS DOOR REACH-IN REFRIGERATOR MODELS

WIDTH x DEPTH x HEIGHT	DOOR HEIGHT	DOOR HINGING	REFRIGERATORS
27" x 33.5" x 78"	Full	Right	CLBM-23R-FG-R
	Full	Left	CLBM-23R-FG-L
	Half	Right	CLBM-23R-HG-R
	Half	Left	CLBM-23R-HS-L

TWO SECTION GLASS DOOR REACH-IN REFRIGERATOR MODELS

WIDTH x DEPTH x HEIGHT	DOOR HEIGHT	DOOR HINGING	REFRIGERATORS
53.7" x 33.5" x 78"	Full	Left/Right	CLBM-49R-FG-LR
	Full	Right/Right	CLBM-49R-FG-RR
	Full	Left/Left	CLBM-49R-FG-LL
	Half	Left/Right	CLBM-49R-HG-LR
	Half	Right/Right	CLBM-49R-HG-RR
	Half	Left/Left	CLBM-49R-HG-LL



CLUC-27R-SD



CLUC-48R-SD



CLUC-48R-DW

STANDARD FEATURES

- Stainless steel exterior with corrosion resistant anodized aluminum interior
- LED display control
- 115/60/1 voltage, self-contained, with cord & plug attached
- Self-closing door(s) with stay-open feature (door models)
- Each drawer accommodates full size 6" deep pans (drawer models)
- Gasket protecting retainer
- Four or six 4" high casters with locks on front casters
- Two heavy duty epoxy coated shelves per section (door models)
- Three-year parts & labor warranty
- Five-year compressor warranty

COMPACT UNDERCOUNTER DOOR MODELS, SELF-CONTAINED

WIDTH x DEPTH x HEIGHT	NUMBER DOORS	REFRIGERATORS	FREEZERS
27.5" x 31.5" x 30"	1	CLUC-27R-SD	CLUC-27F-SD
36.25" x 31.5" x 30"	2	CLUC-36R-SD	CLUC-36F-SD
48.25" x 31.5" x 30"	2	CLUC-48R-SD	CLUC-48F-SD
60.25" x 31.5" x 30"	2	CLUC-60R-SD	CLUC-60F-SD
72.19" x 31.5" x 30"	3	CLUC-72R-SD	CLUC-72F-SD

COMPACT UNDERCOUNTER DRAWER MODELS, SELF-CONTAINED

WIDTH x DEPTH x HEIGHT	NUMBER DRAWERS	REFRIGERATORS	FREEZERS
27.5" x 31.5" x 30"	2	CLUC-27R-DW	CLUC-27F-DW
48.25" x 31.5" x 30"	4	CLUC-48R-DW	CLUC-48F-DW
60.25" x 31.5" x 30"	4	CLUC-60R-DW	CLUC-60F-DW
72.25" x 31.5" x 30"	6	CLUC-72R-DW	N/A

NOTE: All models available with worktop (height increases by 4 inches).



Please refer to energystar.gov to view the most up-to-date product listing and performance data.

REFRIGERATORS
**GLASS DOOR COMPACT
 UNDERCOUNTER MODELS**



CLUC-27R-GD



CLUC-60R-GD



CLUC-72R-GD

STANDARD FEATURES

- Stainless steel exterior with corrosion resistant anodized aluminum interior
- Metal door handle(s)
- Stay-open door(s) feature
- LED display control
- 115/60/1 voltage, self-contained, with cord & plug attached
- Four or six 4" high casters with locks on front casters
- Two heavy duty epoxy coated shelves per door
- Three-year parts & labor warranty
- Five-year compressor warranty



**COMPACT UNDERCOUNTER GLASS DOOR
 REFRIGERATOR MODELS, SELF-CONTAINED**

WIDTH x DEPTH x HEIGHT	NUMBER DOORS	REFRIGERATORS
27.5" x 33" x 30"	1	CLUC-27R-GD
36.25" x 33" x 30"	2	CLUC-36R-GD
48.25" x 33" x 30"	2	CLUC-48R-GD
60.25" x 33" x 30"	2	CLUC-60R-GD
72.25" x 33" x 30"	3	CLUC-72R-GD

NOTE: All models available with worktop (height increases by 4 inches).



Please refer to energystar.gov to view the most up-to-date product listing and performance data.



CLPT-2708-SD



CLPT-4818-SD



CLPT-7230-DW

STANDARD FEATURES

- Stainless steel exterior with corrosion resistant anodized aluminum interior
- LED display control
- 8" or 12" deep white polyethylene cutting board
- 115/60/1 voltage, self-contained, with cord & plug attached
- Self-closing door(s) with stay-open feature
- Gasket protecting retainer
- Four or six 4" high casters with locks on front casters
- Two heavy duty epoxy coated shelves per door
- Three-year parts & labor warranty
- Five-year compressor warranty



COMPACT PREP TABLE DOOR MODELS, SELF-CONTAINED

WIDTH x DEPTH x HEIGHT	REFRIGERATORS	PAN CAPACITY
27.88" x 32.75" x 40"	CLPT-2708-SD	8
36.56" x 32.75" x 40"	CLPT-3610-SD	10
48.56" x 32.75" x 40"	CLPT-4812-SD	12
60.56" x 32.75" x 40"	CLPT-6016-SD	16
72.5" x 32.75" x 40"	CLPT-7220-SD	20

COMPACT PREP TABLE DRAWER MODELS, SELF-CONTAINED

WIDTH x DEPTH x HEIGHT	REFRIGERATORS	PAN CAPACITY
27.88" x 32.75" x 40"	CLPT-2708-DW	8
48.56" x 32.75" x 40"	CLPT-4812-DW	12
60.56" x 32.75" x 40"	CLPT-6016-DW	16
72.5" x 32.75" x 40"	CLPT-7220-DW	20

COMPACT PREP TABLE MEGA TOP DOOR MODELS, SELF-CONTAINED

WIDTH x DEPTH x HEIGHT	REFRIGERATORS	PAN CAPACITY
27.88" x 35.75" x 40"	CLPT-2712-SD	12
36.56" x 35.75" x 40"	CLPT-3615-SD	15
48.56" x 35.75" x 40"	CLPT-4818-SD	18
60.56" x 35.75" x 40"	CLPT-6024-SD	24
72.5" x 35.75" x 40"	CLPT-7230-SD	30

COMPACT PREP TABLE MEGA TOP DRAWER MODELS, SELF-CONTAINED

WIDTH x DEPTH x HEIGHT	REFRIGERATORS	PAN CAPACITY
27.88" x 35.75" x 40"	CLPT-2712-DW	12
48.56" x 35.75" x 40"	CLPT-4818-DW	18
60.56" x 35.75" x 40"	CLPT-6024-DW	24
72.5" x 35.75" x 40"	CLPT-7230-DW	30



CLBC7-L



CLBC4-R



CLBC4-WT-R

STANDARD FEATURES

- Stainless steel exterior and interior
- TXV metering device
- Stay-open/self-closing door
- One food probe
- 2 Chill Modes: Soft or hard chill
- Easy-to-use digital control
- Quickly chill hot food to below 41° F in 90 minutes*
- Three year parts & labor warranty
- Five year compressor warranty

*Chill times will vary depending on product type, quantity, and container used.

REACH-IN BLAST CHILLERS

WIDTH x DEPTH x HEIGHT	CAPACITIES	DOOR HINGING	REFRIGERATORS	TYPE
34.75" x 38.13" x 61.56"*	(7) 18" x 26" or (14) 12" x 20" Pans	Left	CLBC7-L	Reach-In
34.75" x 38.13" x 61.56"*	(7) 18" x 26" or (14) 12" x 20" Pans	Right	CLBC7-R	Reach-In

*NOTE: 61½" height with 4" casters

UNDERCOUNTER BLAST CHILLERS

WIDTH x DEPTH x HEIGHT	CAPACITIES	DOOR HINGING	REFRIGERATORS	TYPE
54.13" x 35.94" x 28"*	(4) 18" x 26" or (8) 12" x 20" Pans	Left	CLBC4-L	Reach-In
54.13" x 35.94" x 28"*	(4) 18" x 26" or (8) 12" x 20" Pans	Right	CLBC4-R	Reach-In
54.13" x 35.94" x 32"**	(4) 18" x 26" or (8) 12" x 20" Pans	Left	CLBC4-WT-L	Worktop
54.13" x 35.94" x 32"**	(4) 18" x 26" or (8) 12" x 20" Pans	Right	CLBC4-WT-R	Worktop

*NOTE: 32" height without 4" casters

**NOTE: 28" height without 4" casters

UNDERSTANDING TRAUlsen MODEL NUMBERS

CENTERLINE™ BY TRAUlsen REACH-INS, COMPACTS & PREP TABLES

CENTERLINE™ REACH-INS

CL	BM-	23	R-	FS-	L
POSITION (1)	POSITION (2)	POSITION (3)	POSITION (4)	POSITION (5)	POSITION (6)
SERIES CL Centerline™	SYSTEM LOCATION/TYPE BM Bottom Mounted Self-Contained	CABINET WIDTH (SECTIONS) 23 (1-section) 49 (2-section)	TYPE OF CABINET R Refrigerator F Freezer	TYPE OF DOOR(S) FS Full-Height Solid HS Half-Height Solid FG Full-Height Hinged Glass HG Half-Height Hinged Glass	HINGING L Left R Right LR Left/Right LL Left/Left RR Right/Right

CENTERLINE™ COMPACTS

CL	UC-	27	R-	SD-	L
POSITION (1)	POSITION (2)	POSITION (3)	POSITION (4)	POSITION (5)	POSITION (6)
SERIES CL Centerline™	TYPE OF CABINET UC Undercounter	CABINET WIDTH 27 27" 36 36" 48 48" 60 60" 72 72"	TYPE OF CABINET R Refrigerator F R Freezer	TYPE OF DOOR(S) SD Solid Door(s) GD Glass Door(s) DW Drawers	HINGING L Left R Right LR Left/Right LL Left/Left RR Right/Right LRR Left/Right/Right RRR Right/Right/Right LLL Left/Left/Left WT If WT is present, the Undercounter is a Worktop

CENTERLINE™ PREP TABLES

CL	PT-	27	12-	SD-	L
POSITION (1)	POSITION (2)	POSITION (3)	POSITION (4)	POSITION (5)	POSITION (6)
SERIES CL Centerline™	TYPE OF CABINET PT Prep Table	CABINET WIDTH 27 27" 36 36" 48 48" 60 60" 72 72"	NUMBER OF PANS 8 8 Pans 10 10 Pans 12 12 Pans 15 15 Pans 16 16 Pans 18 18 Pans 20 20 Pans 24 24 Pans 30 30 Pans	TYPE OF DOOR(S) SD Solid Door(s) DW Drawers	HINGING L Left R Right LR Left/Right LL Left/Left RR Right/Right LRR Left/Right/Right RRR Right/Right/Right LLL Left/Left/Left

CENTERLINE™ BLAST CHILLERS

CL	BC	7-	L
POSITION (1)	POSITION (2)	POSITION (3)	POSITION (6)
SERIES CL Centerline™	TYPE OF CABINET BC Blast Chiller	CABINET WIDTH 7 Reach-In, (7) 18" x 26" Sheet Pans 4 Undercounter, (4) 18" x 26" Sheet Pans	HINGING L Left R Right WT If WT is present, the Undercounter is a Worktop

CENTERLINE™ REACH-INS TRAY SLIDE & SHELF VERSATILITY CHART

TRAY SLIDES

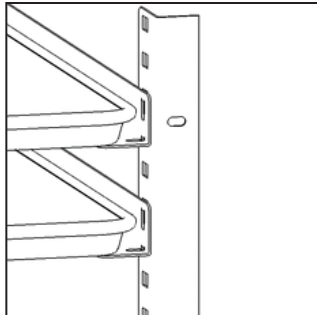

#1 Tray Slides Standard

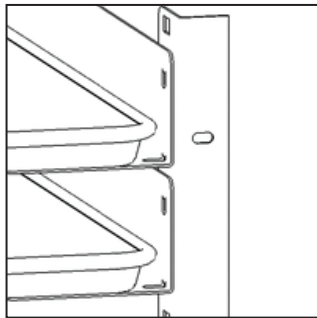

Universal Tray Slides Standard

TRAY SLIDES

DESCRIPTION	SPACING			
#1 TRAY SLIDES – STANDARD				
16 ga. stainless steel angle type for bottom support of: (1) 18" x 26" Pan	2"	3"	4"	5"
Behind full height door – all models	26	17	13	10
Behind upper half height door – all models	12	8	6	4
Behind lower half height door – all models	12	8	6	5

DESCRIPTION	SPACING		
UNIVERSAL TRAY SLIDES – STANDARD			
16 ga. stainless steel angle type for bottom support of: (1) 18" x 26" Pan or (2) 12" x 20" Pans	4"	5"	6"
Behind full height door – all models	13	10	8
Behind upper half height door – all models	6	4	4
Behind lower half height door – all models	6	5	4

SHELVES

CAPACITY	STD.	MAX.
Behind full height door mounted on standard shelf pins	3	8
Behind half height door mounted on standard shelf pins	3	7
Behind full height door mounted on optional pilasters	3	12 (4" spacing)
Behind half height door mounted on optional pilasters	3	11 (4" spacing)

NOTES:

1. For all after market parts call Traulsen parts department at 800-825-8220.
2. The above quantities represent the maximum amount of tray slides recommended by Traulsen to achieve best air circulation and refrigeration performance.
3. Optional tray slides are not available for Compact Undercounter and Prep Table models.
4. All Centerline™ by Traulsen accessory kits are pre-packaged for easy installation at the job site.

The “Traulsen Difference” is much more than just a catchy advertising slogan. It aptly sums up our overall philosophy of providing both high-quality and high ownership value in everything we do.

Let’s face it, there is less expensive refrigeration equipment on the market. However, only the refrigeration equipment works 24/7 in your kitchen, has the ability to lose costly product and upset an entire operation, so this is no place for compromises.

Traulsen recognizes this, so we design and build our equipment to deliver in all the vital areas of importance to a foodservice operation. Durability and reliable operation are just the beginning. They also offer the benefit of energy efficiency, large storage capacity, ease of use, long equipment life, and a host of value-added features.



Most of all they are designed for performance. After all, temperature maintenance and recovery are absolutely critical to both food safety and controlling food costs. In this we excel, that’s why Traulsen has been the industry leader for eight decades and counting.

Refrigeration System



By combining balanced, high quality components, precise microprocessor controls and careful construction, our systems cycle less often, and offer the efficiency you’re looking for while still providing the outstanding reliability and performance your operation needs.

Easy to Use Controls



Traulsen uses advanced “plug & play” microprocessor controls that are precise, promote efficiency, and are easy to use, providing far greater reliability.

Interior Arrangements

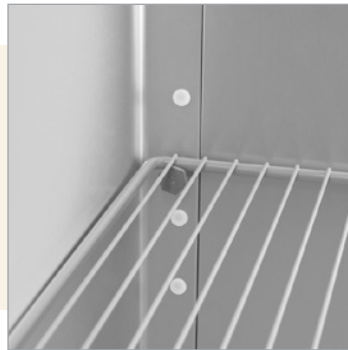

Each shelf has a rated capacity of approximately 225 lbs. They span the entire inside width of the cabinet, are mounted on a pin system which does not require tools to remove, and don't ever need "junior" shelves between them.

Condenser Cleaning



Traulsen locates the condenser coil right behind the lift-up louver panel, facing front, making it so easy to access and clean. Most R&A series models come standard with StayClear™ Condenser Coil which has innovative technology that dramatically reduces blockages and the build-up of dirt, keeping the condenser clear.

Metering Device

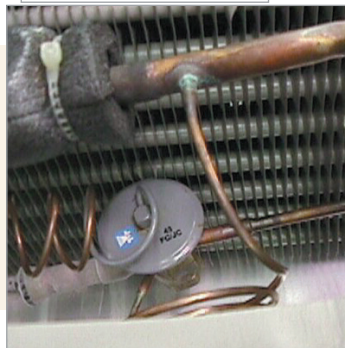

Use of a TXV allows for better temperature recovery than possible with capillary tube designs. This is especially important during busy lunch and dinner periods where the doors are opened frequently. The Traulsen unit will recover temperature quickly, keeping your food safe and fresh.

Raised Metal Door Liner



Much more durable than those made of plastic, metal door liners are unlikely to ever crack or break. Their raised design protects the gaskets from damage during loading and unloading. As a result, the gaskets will have to be replaced less often.

Metal Construction



The doors are metal. The handles are metal. The breaker caps are metal. There is no plastic seam surrounding the doors or cabinet's front perimeter. There is nothing but high quality metal used throughout.

Cam-Lift Hinge Design & Concealed Light Switches

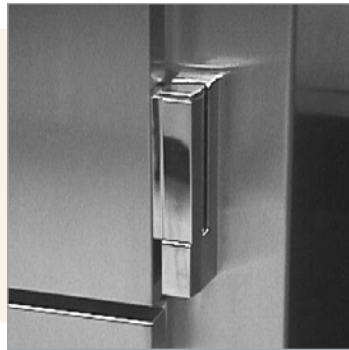

Traulsen uses cam-lift type door hinges. These self-close at up to 90°, have a stay-open feature past 120°, and can be opened past 180° without damage. They are heavy duty and include a lifetime warranty. Hinges also conceal a light switch that operates interior lights automatically when the door is opened, while also protecting the switch from damage during loading and unloading.

Insulation

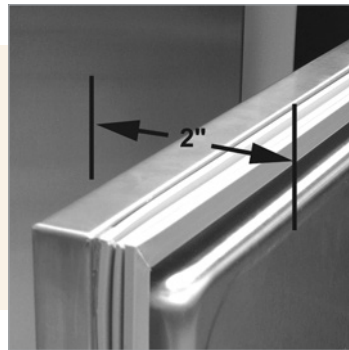

Traulsen insulates the entire cabinet, including the doors, with at least 2" foamed in place insulation. Not only does this provide superior insulating characteristics, but it also adds significant strength to our already rugged design.

Air-Flow Pattern

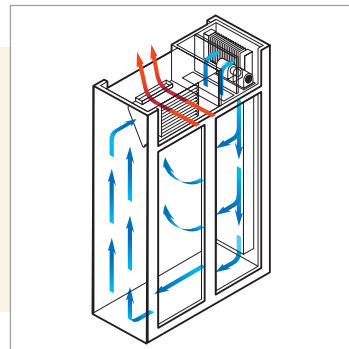

Traulsen's clockwise air-flow pattern keeps cold air in and warm air out much better than back to front designs, which tend to spill cold air out on to the floor whenever opened. A key element is our rear biased return air-duct that protects the system from ingesting warm kitchen air whenever the door is opened.

STANDARD FEATURES

- Stainless steel exterior front and door(s) finish
- Corrosion resistant anodized aluminum one-piece sides
- Durable anodized aluminum interior
- Microprocessor control with LED display
- 115/60/1 voltage, self-contained, with cord and plug attached (208-230/115V 3-section freezers)
- Automatically activated LED light with concealed switch
- -10°F freezer capability (freezers only)
- Self-closing door(s) with stay-open feature and lock(s)
- Magnetic snap-in EZ-Clean door gasket(s)
- Three epoxy coated shelves per section
- Four 6" high casters with brakes
- Automatic, non-electric condensate evaporator
- Lifetime warranty on door hinges & handles
- Three-year parts & labor warranty
- Five-year compressor warranty



G20010



ONE SECTION REACH-IN SOLID DOOR MODELS

WIDTH x DEPTH x HEIGHT	DOOR HEIGHT	DOOR HINGING	REFRIGERATORS	FREEZERS
29 ⁷ / ₈ " x 35" x 83 ³ / ₄ "	Full	Right	G10010	G12010
	Full	Left	G10011	G12011
	Half	Right	G10000	G12000
	Half	Left	G10001	G12001

TWO SECTION REACH-IN SOLID DOOR MODELS

WIDTH x DEPTH x HEIGHT	DOOR HEIGHT	DOOR HINGING	REFRIGERATORS	FREEZERS
52 ¹ / ₈ " x 35" x 83 ³ / ₄ "	Full	Left/Right	G20010	G22010
	Full	Right/Left	G20011	G22011
	Full	Right/Right	G20012	G22012
	Full	Left/Left	G20013	G22013
	Half	Left/Right	G20000	G22000
	Half	Right/Left	G20001	G22001
	Half	Right/Right	G20002	G22002
	Half	Left/Left	G20003	G22003

THREE SECTION REACH-IN SOLID DOOR MODELS

WIDTH x DEPTH x HEIGHT	DOOR HEIGHT	DOOR HINGING	REFRIGERATORS	FREEZERS
76 ⁵ / ₁₆ " x 35" x 83 ³ / ₄ "	Full	Left/Right/Right	G30010	G31310
	Full	Left/Left/Right	G30011	G31311
	Full	Right/Right/Right	G30012	G31312
	Full	Left/Left/Left	G30013	G31313
	Half	Left/Right/Right	G30000	G31300
	Half	Left/Left/Right	G30001	G31301
	Half	Right/Right/Right	G30002	G31302
	Half	Left/Left/Left	G30003	G31303

NOTE: All models available with optional R290 refrigerant if needed.

Concealed Light Switches

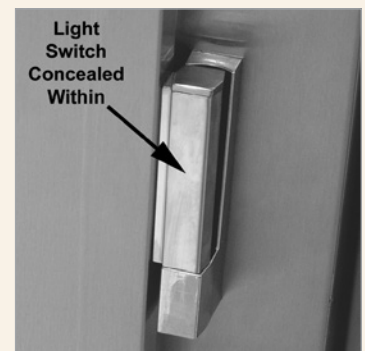

Traulsen solid door models include a concealed light switch inside every door hinge (even on half-height door models). This operates the interior lights automatically whenever the door is opened, while also protecting the switch from damage during loading/unloading.

 Please refer to energystar.gov to view the most up-to-date product listing and performance data.

STANDARD FEATURES

- Stainless steel exterior front and door(s) finish
- Corrosion resistant anodized aluminum one-piece sides
- Durable anodized aluminum interior
- Microprocessor control with LED display
- 115/60/1 voltage, with cord and plug attached, consult factory for other voltages
- LED light with exterior switch
- Self-closing door(s) with stay-open feature and lock(s)
- Magnetic snap-in EZ-Clean door gasket(s)
- Three epoxy coated shelves per section
- Four 6" high casters with brakes
- Automatic, non-electric condensate evaporator
- Three-year parts & labor warranty
- Five-year compressor warranty

ONE SECTION REACH-IN GLASS DOOR MODELS

WIDTH x DEPTH x HEIGHT	DOOR HEIGHT	DOOR HINGING	REFRIGERATORS
29 ⁷ / ₈ " x 35" x 83 ¹ / ₄ "	Full	Right	G11010
	Full	Left	G11011
	Half	Right	G11000
	Half	Left	G11001



G21000



TWO SECTION REACH-IN GLASS DOOR MODELS

WIDTH x DEPTH x HEIGHT	DOOR HEIGHT	DOOR HINGING	REFRIGERATORS
52 ¹ / ₂ " x 35" x 83 ¹ / ₄ "	Full	Left/Right	G21010
	Full	Right/Left	G21011
	Full	Right/Right	G21012
	Full	Left/Left	G21013
	Half	Left/Right	G21000
	Half	Right/Left	G21001
	Half	Right/Right	G21002
	Half	Left/Left	G21003

THREE SECTION REACH-IN GLASS DOOR MODELS

WIDTH x DEPTH x HEIGHT	DOOR HEIGHT	DOOR HINGING	REFRIGERATORS
76 ¹ / ₁₆ " x 35" x 83 ¹ / ₄ "	Full	Left/Right/Right	G32010
	Full	Left/Left/Right	G32011
	Full	Right/Right/Right	G32012
	Full	Left/Left/Left	G32013
	Half	Left/Right/Right	G32000
	Half	Left/Left/Right	G32001
	Half	Right/Right/Right	G32002
	Half	Left/Left/Left	G32003

NOTE: All models available with optional R290 refrigerant if needed.

Metering Device

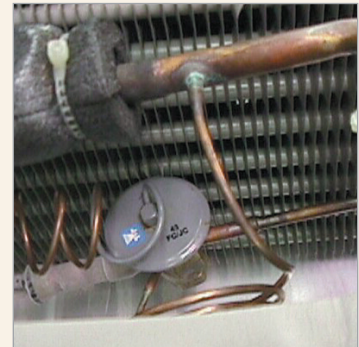

Use of a TXV allows for faster temp recovery than possible with capillary tube designs. This is especially important during busy periods where the doors are opened frequently. The Traulsen will recover temperature quickly, maintaining consistent, safe temperatures.

REFRIGERATORS & FREEZERS REACH-IN FULL HEIGHT GLASS DOOR MERCHANDISERS

STANDARD FEATURES

- Stainless steel exterior front finish
- Corrosion resistant anodized aluminum one-piece sides
- Durable anodized aluminum interior
- Plug & play microprocessor control with LED display
- LED display lights – patented in-door design
- Self-closing door(s) with stay-open feature & lock(s)
- 115/60/1 voltage, self-contained, with cord & plug attached
- Magnetic snap-in EZ-Clean door gasket(s)
- Three (3) epoxy coated shelves on pins per section
- Four 6" high casters with brakes
- Automatic, non-electric condensate evaporator
- Guaranteed for life door hinges
- Three-year parts & labor warranty
- Five-year compressor parts warranty



G13011-053



G23010-053

ONE SECTION REACH-IN MERCHANDISER WITH LED LIGHTS MODELS

WIDTH x DEPTH x HEIGHT	DOOR HINGING	REFRIGERATORS	FREEZERS
29 ⁷ / ₈ " x 35" x 83 ⁷ / ₁₆ "	Right	G11010-043	G13010-053
	Left	G11011-043	G13011-053

TWO SECTION REACH-IN MERCHANDISER WITH LED LIGHTS MODELS

WIDTH x DEPTH x HEIGHT	DOOR HINGING	REFRIGERATORS	FREEZERS
52 ⁵ / ₈ " x 35" x 83 ⁷ / ₁₆ "	Left/Right	G21010-043	G23010-053

THREE SECTION REACH-IN MERCHANDISER WITH LED LIGHTS MODELS

WIDTH x DEPTH x HEIGHT	DOOR HINGING	REFRIGERATORS	FREEZERS
76 ⁵ / ₁₆ " x 35" x 83 ⁷ / ₁₆ "	Left/Right/Right	G32010-043	G33010-053
	Left/Left/Right	G32011-043	G33011-053

STANDARD FEATURES

- High quality stainless steel exterior front and door(s)
- Corrosion resistant anodized aluminum one-piece sides
- Durable anodized aluminum interior
- Plug and play microprocessor control with LED display
- Self-closing door(s) with stay-open feature and lock(s)
- Magnetic snap-in EZ-Clean door gasket(s)
- Three plated shelves per section
- Four 6" high casters with brakes
- Lifetime warranty on door hinges & handles
- Three-year parts & labor warranty

ONE SECTION REACH-IN MODELS

WIDTH x DEPTH x HEIGHT	DOOR HEIGHT	DOOR HINGING	HEATED CABINETS
29 ⁷ / ₈ " x 35" x 83 ³ / ₄ "	Half	Right	G14300
	Half	Left	G14301
	Full	Right	G14310
	Full	Left	G14311



G14310

TWO SECTION REACH-IN MODELS

WIDTH x DEPTH x HEIGHT	DOOR HEIGHT	DOOR HINGING	HEATED CABINETS
52 ¹ / ₈ " x 35" x 83 ³ / ₄ "	Half	Left/Right	G24300
	Half	Right/Right	G24302
	Half	Left/Left	G24303
	Full	Left/Right	G24310
	Full	Right/Right	G24312
	Full	Left/Left	G24313



G24314P

ONE SECTION PASS-THRU MODELS

WIDTH x DEPTH x HEIGHT	DOOR HEIGHT	DOOR HINGING		HEATED CABINETS
		CONTROL SIDE	OTHER SIDE**	
29 ⁷ / ₈ " x 37 ¹⁵ / ₁₆ " x 83 ³ / ₄ "	Half	Right	Right	G14302P
	Half	Right	Left	G14303P
	Half	Left	Left	G14304P
	Half	Left	Right	G14305P
	Full	Right	Right	G14312P
	Full	Right	Left	G14313P
	Full	Left	Left	G14314P
	Full	Left	Right	G14315P

TWO SECTION PASS-THRU MODELS

WIDTH x DEPTH x HEIGHT	DOOR HEIGHT	DOOR HINGING		HEATED CABINETS
		CONTROL SIDE	OTHER SIDE**	
52 ¹ / ₈ " x 37 ¹⁵ / ₁₆ " x 83 ³ / ₄ "	Half	Left/Right	Left/Right	G24304P
	Half	Left/Left	Left/Left	G24305P
	Half	Right/Right	Right/Right	G24307P
	Full	Left/Right	Left/Left	G24312P
	Full	Left/Right	Left/Right	G24314P
	Full	Left/Left	Left/Left	G24315P
	Full	Right/Right	Right/Right	G24317P
	Full	Left/Right	Right/Right	G24318P

** = Hinging when viewed from that side

Heating System



By using large, low watt-density heating elements combined with low velocity fans, Traulsen's hot food holding cabinets offer outstanding performance with limited temperature stratification, most are ENERGY STAR® certified for efficiency, start-up quickly and greatly reduce lifetime service costs.

 Please refer to energystar.gov to view the most up-to-date product listing and performance data.

REFRIGERATORS

PASS-THRU SOLID DOOR & GLASS DOOR MODELS

STANDARD FEATURES

- High quality stainless steel exterior front and door(s)
- Corrosion resistant anodized aluminum one-piece sides
- Durable anodized aluminum interior
- Microprocessor control with LED display
- Top-mounted, balanced, self-contained refrigeration system
- Large evaporator coil outside the food zone
- Load-sure guard protects against improper loading
- Full or half height stainless steel door(s) or glass door(s) with lock(s)
- Self-closing door(s) with stay-open feature at 120 degrees
- Lifetime warranty on cam-lift hinges and workflow handles
- Automatically activated LED lights
- Three (3) adjustable epoxy coated shelves on pins per section
- Energy saving automatic non-electric condensate evaporator
- Magnetic snap-in EZ-Clean door gasket(s)
- Gasket-protecting anodized aluminum door liner
- Anti-condensate door perimeter heaters
- Thermostatic expansion valve metering device provides quick refrigeration recovery times
- Stainless steel one-piece louver assembly
- Set of four (4) 6" high casters with brakes
- Three-year parts & labor warranty
- Five-year compressor warranty



G10012P



ONE SECTION PASS-THRU SELF-CONTAINED SOLID DOOR MODELS

WIDTH x DEPTH x HEIGHT	DOOR HEIGHT	DOOR HINGING		REFRIGERATORS
		CONTROL SIDE	NON-CONTROL SIDE	
29 ⁷ / ₈ " x 37 ¹⁵ / ₁₆ " x 83 ³ / ₄ "	Half	Right	Right	G10002P
	Half	Right	Left	G10003P
	Half	Left	Left	G10004P
	Half	Left	Right	G10005P
	Full	Right	Right	G10012P
	Full	Right	Left	G10013P
	Full	Left	Left	G10014P
	Full	Left	Right	G10015P

TWO SECTION PASS-THRU SELF-CONTAINED SOLID DOOR MODELS

WIDTH x DEPTH x HEIGHT	DOOR HEIGHT	DOOR HINGING		REFRIGERATORS
		CONTROL SIDE	NON-CONTROL SIDE	
52 ¹ / ₈ " x 37 ¹⁵ / ₁₆ " x 83 ³ / ₄ "	Half	Left/Right	Left/Right	G20004P
	Half	Left/Left	Left/Left	G20005P
	Half	Right/Left	Right/Left	G20006P
	Half	Right/Right	Right/Right	G20007P
	Full	Left/Right	Left/Left	G20012P
	Full	Left/Right	Right/Right	G20013P
	Full	Left/Right	Left/Right	G20014P
	Full	Left/Left	Left/Left	G20015P
	Full	Right/Left	Right/Left	G20016P
	Full	Right/Right	Right/Right	G20017P

NOTE: All models available with optional R290 refrigerant if needed.

REFRIGERATORS

PASS-THRU SOLID DOOR & GLASS DOOR MODELS (CONTINUED)

TWO SECTION PASS-THRU SELF-CONTAINED GLASS DOOR MODELS

WIDTH x DEPTH x HEIGHT	DOOR HEIGHT	DOOR HINGING		REFRIGERATORS
		CONTROL SIDE	NON-CONTROL SIDE	
52 $\frac{1}{8}$ " x 37 $\frac{15}{16}$ " x 83 $\frac{3}{4}$ "	Half	Left/Right	Left/Right	G21004P
	Half	Left/Left	Left/Left	G21005P
	Half	Right/Left	Right/Left	G21006P
	Half	Right/Right	Right/Right	G21007P
	Full	Left/Right	Left/Right	G21014P
	Full	Left/Left	Left/Left	G21015P
	Full	Right/Left	Right/Left	G21016P
	Full	Right/Right	Right/Right	G21017P

ONE SECTION PASS-THRU SELF-CONTAINED GLASS & SOLID DOOR COMBINATION MODELS

WIDTH x DEPTH x HEIGHT	CONTROL SIDE		NON-CONTROL SIDE		REFRIGERATORS
	DOOR HEIGHT	DOOR HINGING	DOOR HEIGHT	DOOR HINGING	
29 $\frac{7}{8}$ " x 37 $\frac{15}{16}$ " x 83 $\frac{3}{4}$ "	Solid Half	Right	Glass Half	Right	G16002P
	Solid Half	Right	Glass Half	Left	G16003P
	Solid Half	Left	Glass Half	Left	G16004P
	Solid Half	Left	Glass Half	Right	G16005P
	Solid Full	Right	Glass Full	Right	G16012P
	Solid Full	Right	Glass Full	Left	G16013P
	Solid Full	Left	Glass Full	Left	G16014P
	Solid Full	Left	Glass Full	Right	G16015P
	Glass Half	Right	Solid Half	Right	G17002P
	Glass Half	Right	Solid Half	Left	G17003P
	Glass Half	Left	Solid Half	Left	G17004P
	Glass Half	Left	Solid Half	Right	G17005P
	Glass Full	Right	Solid Full	Right	G17012P
	Glass Full	Right	Solid Full	Left	G17013P
	Glass Full	Left	Solid Full	Left	G17014P
	Glass Full	Right	Solid Full	Right	G17015P

TWO SECTION PASS-THRU SELF-CONTAINED GLASS & SOLID DOOR COMBINATION MODELS

WIDTH x DEPTH x HEIGHT	CONTROL SIDE		NON-CONTROL SIDE		REFRIGERATORS
	DOOR HEIGHT	DOOR HINGING	DOOR HEIGHT	DOOR HINGING	
52 $\frac{1}{8}$ " x 37 $\frac{15}{16}$ " x 83 $\frac{3}{4}$ "	Solid Half	Left/Right	Glass Half	Left/Right	G26004P
	Solid Half	Left/Left	Glass Half	Left/Left	G26005P
	Solid Half	Right/Left	Glass Half	Right/Left	G26006P
	Solid Half	Right/Right	Glass Half	Right/Right	G26007P
	Solid Full	Left/Right	Glass Full	Left/Right	G26014P
	Solid Full	Left/Left	Glass Full	Left/Left	G26015P
	Solid Full	Right/Left	Glass Full	Right/Left	G26016P
	Solid Full	Right/Right	Glass Full	Right/Right	G26017P
	Glass Half	Left/Right	Solid Half	Left/Right	G27004P
	Glass Half	Left/Left	Solid Half	Left/Left	G27005P
	Glass Half	Right/Left	Solid Half	Right/Left	G27006P
	Glass Half	Right/Right	Solid Half	Right/Right	G27007P
	Glass Full	Left/Right	Solid Full	Left/Right	G27014P
	Glass Full	Left/Left	Solid Full	Left/Left	G27015P
	Glass Full	Right/Left	Solid Full	Right/Left	G27016P
	Glass Full	Right/Right	Solid Full	Right/Right	G27017P

NOTE: All models available with optional R290 refrigerant if needed.

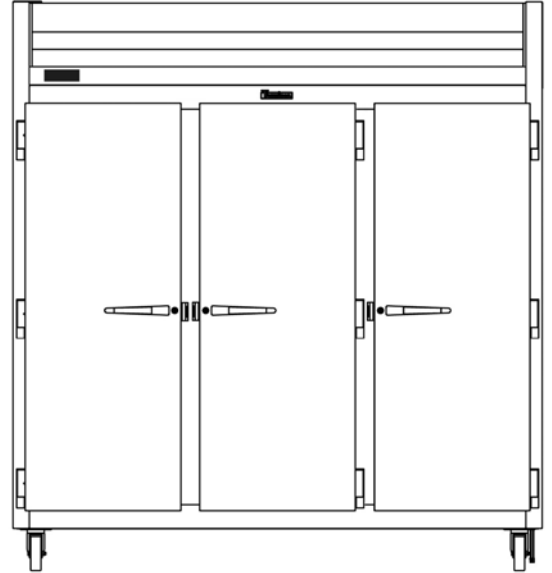
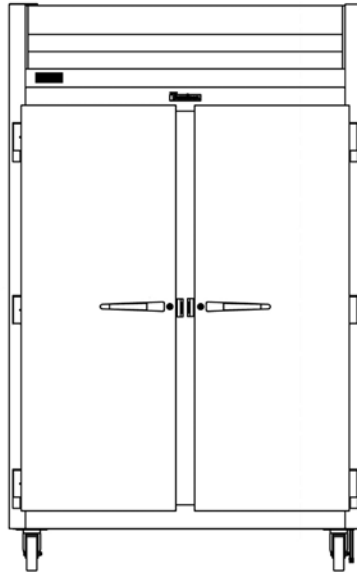
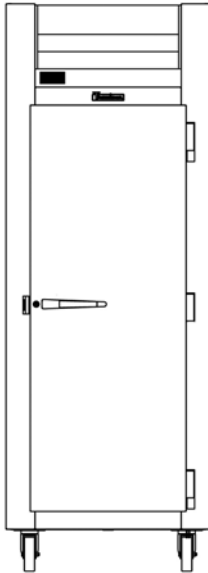

ONE SECTION MODELS

G1ACC-TK1	8 Pairs #1 Tray Slides
G1ACC-TK2	2 Pairs #4 Tray Slides
G1ACC-TK4	7 Pairs Universal Tray Slides
G1ACC-SHLF1*	3 Epoxy Coated Shelves on Pins
G1ACC-SHLF2*	3 Epoxy Coated Shelves on Pilasters
G1ACC-SHLF3	3 Clear Coated Shelves on Pins
G1ACC-SHLF4	3 Clear Coated Shelves on Pilasters
G1ACC – BTL5*	Bottle Shelf Kit, 5 Shelves with Mounting Hardware (Glass Door Models Only)

*Not available with heated cabinets

TWO SECTION MODELS

LEFT AND RIGHT SECTIONS	
G23ACC-TK1LR*	8 Pairs #1 Tray Slides
G23ACC-TK2LR*	2 Pairs #4 Tray Slides
G23ACC-TK4LR	7 Pairs Universal Tray Slides
G2ACC-BTL5*	Bottle Shelf Kit, 5 Shelves with Mounting Hardware (Glass Door Models Only)
LEFT SECTION	
G23ACC-SHLF1*	3 Epoxy Coated Shelves on Pins
G23ACC-SHLF2*	3 Epoxy Coated Shelves on Pilasters
G23ACC-SHLF4	3 Clear Coated Shelves on Pilasters
RIGHT SECTION	
G23ACC-SHLF5*	3 Epoxy Coated Shelves on Pins
G23ACC-SHLF6*	3 Epoxy Coated Shelves on Pilasters
G23ACC-SHLF7	3 Clear Coated Shelves on Pins
G23ACC-SHLF8	3 Clear Coated Shelves on Pilasters

*Not available with heated cabinets

THREE SECTION MODELS

LEFT AND RIGHT SECTIONS	
G23ACC-TK1LR	8 Pairs #1 Tray Slides
G23ACC-TK2LR	2 Pairs #4 Tray Slides
G23ACC-TK4LR	7 Pairs Universal Tray Slides
G3ACC-BTL5-LR*	Bottle Shelf Kit, 5 Shelves with Mounting Hardware (Glass Door Models Only)
LEFT SECTION	
G23ACC-SHLF1	3 Epoxy Coated Shelves on Pins
G23ACC-SHLF2	3 Epoxy Coated Shelves on Pilasters
G23ACC-SHLF3	3 Clear Coated Shelves on Pins
G23ACC-SHLF4	3 Clear Coated Shelves on Pilasters
CENTER SECTION	
G3ACC-TK1C	8 Pairs #1 Tray Slides
G3ACC-TK2C	2 Pairs #4 Tray Slides
G3ACC-TK4C	7 Pairs IRS Universal Tray Slides
G3ACC-SHLF5	3 Epoxy Coated Shelves on Pins
G3ACC-SHLF6	3 Epoxy Coated Shelves on Pilasters
G3ACC-SHLF7	3 Clear Coated Shelves on Pins
G3ACC-SHLF8	3 Clear Coated Shelves on Pilasters
G3ACC-BTL5-C	Bottle Shelf Kit, 5 Shelves with Mounting Hardware (Glass Door Models Only)
RIGHT SECTION	
G23ACC-SHLF5	3 Epoxy Coated Shelves on Pins
G23ACC-SHLF6	3 Epoxy Coated Shelves on Pilasters
G23ACC-SHLF7	3 Clear Coated Shelves on Pins
G23ACC-SHLF8	3 Clear Coated Shelves on Pilasters

*Requires 2 kits to outfit both left and right sections

ADDITIONAL SHELVES, TRAY SLIDES & SUPPORTS

ONE SECTION MODELS	
G1ACC-SHLF5	1 Epoxy Coated Shelf with Pins & Clips
G1ACC-SHLF6	1 Clear Coated Shelf with Pins & Clips
G12ACC-BTL1	Bottle Shelf Kit, 1 Shelf with Clips (Mounting Hardware not Included)
TWO SECTION MODELS	
G23ACC-SHLF9	1 Epoxy Coated Shelf with Pins & Clips, Left Section
G23ACC-SHLF10	1 Clear Coated Shelf with Pins & Clips, Left Section
G23ACC-SHLF11	1 Epoxy Coated Shelf with Pins & Clips, Right Section
G23ACC-SHLF12	1 Clear Coated Shelf with Pins & Clips, Right Section
THREE SECTION MODELS	
G23ACC-SHLF9	1 Epoxy Coated Shelf with Pins & Clips, Left Section
G23ACC-SHLF10	1 Clear Coated Shelf with Pins & Clips, Left Section
G3ACC-SHLF15	1 Epoxy Coated Shelf with Pins & Clips, Center Section
G3ACC-SHLF16	1 Clear Coated Shelf with Pins & Clips, Center Section
G23ACC-SHLF11	(1) Epoxy Coated Shelf with Pins & Clips, Right Section
G23ACC-SHLF12	(1) Clear Coated Shelf with Pins & Clips, Right Section

EZ-CHANGE KITS

ONE & THREE SECTION MODELS (center only) (kits accommodate one half section)	
G13ACC-1EZ	4 Pairs #1 Tray Slides with Pilasters
G13ACC-UEZ	3 Pairs Universal with Pilasters
G13ACC-HDUEZ	3 Pairs Heavy Duty Universal with Pilasters
TWO & THREE SECTION MODELS (left & right only) (kits accommodate one half section)	
G23ACC-1EZ	4 Pairs #1 Tray Slides with Pilasters
G23ACC-UEZ	3 Pairs Universal with Pilasters*
G23ACC-HDUEZ	3 Pairs Heavy Duty Universal with Pilasters*
OTHER ACCESSORY KITS	
GSACC-1EZ	1 Pair #1 EZ Tray Slides
GSACC-UEZ	1 Pair Universal EZ Tray Slides*
GSACC-HDUEZ	1 Pair Heavy Duty Universal EZ Tray Slides*

*Only standard universal tray slides available for 2 section G-Series heated cabinets.

TRAY SLIDES

EZ-CHANGE TRAY SLIDES

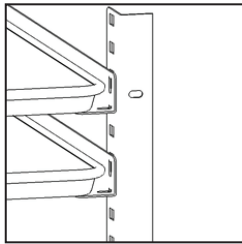

#1 Tray Slides Standard

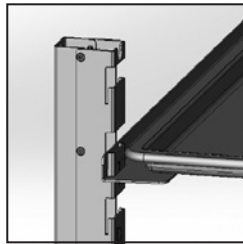

#1 Tray Slides EZ-Change

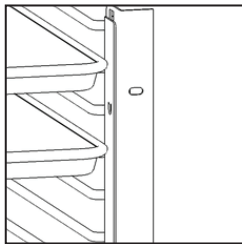

#4 Tray Slides Standard

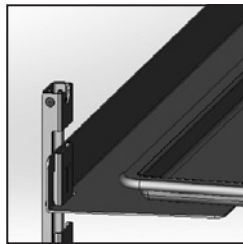

Universal Tray Slides EZ-Change

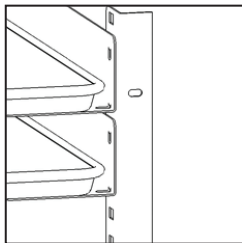

Universal Tray Slides Standard

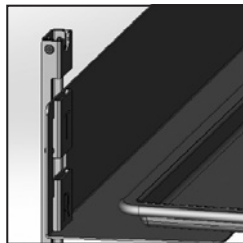

Heavy-Duty Universal Tray Slides EZ-Change

NOTES:

- For all after market parts call Traulsen parts department 800-825-8220.
- The above quantities represent the maximum amount of tray slides recommended by Traulsen to achieve best air circulation and refrigeration performance.
- Optional tray slides are not available for Compact Undercounter and Prep Table models.
- EZ-Change Interior Universal Tray Slides max weight 75 lbs. EZ-Change Heavy Duty Universal Tray Slides max weight 125 lbs.*
- #1, #4, universal and HD Universal EZ-Change tray slides are not available for 2 section G-Series heated cabinets.*
- All G-Series accessory kits are pre-packaged for easy installation at the job site.

TRAY SLIDES

DESCRIPTION	SPACING			
#1 TRAY SLIDES (NOT AVAILABLE FOR 2 SECTION G HEATED)*				
16 ga. stainless steel angle type for bottom support of: (1) 18" x 26" Pan or (2) 14" x 18" Pans	2"	3"	4"	5"
Behind full height door – all models	28	19	14	11
Behind upper half height door – all models	13	9	7	5
Behind lower half height door – all models	13	9	7	5
#1 Tray Slides – EZ-Change Interior (Not available for 2 section G Heated)*	2"	4"		
Behind full height door – all models	26	13		
Behind half height door – all models	12	6		
#4 TRAY SLIDES – STANDARD (NOT AVAILABLE FOR 2 SECTION G HEATED)*				
Plated steel rod type for rim support of: (1) 18" x 26" Pan (One pair of #4 tray slides accommodates one half section)	1-1/2"			
Behind full height door – all models	38			
Behind upper half height door – all models	18			
Behind lower half height door – all models	18			
UNIVERSAL TRAY SLIDES – STANDARD				
16 ga. stainless steel angle type for bottom support of: (1) 18" x 26" Pan or (2) 14" x 18" Pans or (2) 12" x 20" Pans (For heated cabinets reduce available number of tray slides by 1 (full door and the upper section of a half-door))	4"	5"	6"	
Behind full height door – all models	14	11	9	
Behind upper half height door – all models	6	5	4	
Behind lower half height door – all models	7	5	4	
Universal Tray Slides – EZ-Change Interior (Not available for 2 G Section Heated) (For heated cabinets reduce available number of tray slides by 1 (full door and the upper section of a half-door))	2-1/4"		4-1/2"	
Behind full height door – all models	22		11	
Behind half height door – all models	11		5	
Heavy-Duty Universal Tray Slides – EZ-Change Interior* (Not available for 2 G Section Heated) (For heated cabinets reduce available number of tray slides by 1 (full door and the upper section of a half-door))	4-1/2"		9"	
Behind full height door – all models	10		5	
Behind half height door – all models	5		2	

SHELVES (SOME SHELVES ARE NOT AVAILABLE FOR G HEATED)

CAPACITY	STD.	MAX.
Behind full height door mounted on standard shelf pins	3	9
Behind half height door mounted on standard shelf pins	3	8
Behind full height door mounted on optional pilasters	3	13 (4" spacing)
Behind half height door mounted on optional pilasters	3	12 (4" spacing)

G-SERIES REACH-IN MODEL NUMBERS

SERIES (1)	SECTIONS (2)	REFRIGERATOR/FREEZER/HEATED (3)	VOLTAGE (4)	DOOR HEIGHT (5)	HINGING (6)	PASS THRU (7)	REFRIGERATION SYSTEM (8)	REFRIGERANT TYPE (9)	LIGHTS (10)
G	1	0 = Solid Door Ref 1 = Glass Door Ref 2 = Solid Door Freezer 3 = Glass Door Freezer 4 = Hot Food 6 = Solid Front Door / Glass Rear Door Ref 7 = Glass Front Door / Solid Rear Door Ref	0 = 115/60/1 1 = 220/50/1 3 = 208-230/115/60/1	1 = Full 0 = Half	Refer to Price Book or AutoQuotes	Pass Thru (P)	0 = Self Contained	4 = R450A 5 = R448A	3 = LED
G	2	0 = Solid Door Ref 1 = Glass Door Ref 2 = Solid Door Freezer 3 = Glass Door Freezer 4 = Hot Food 6 = Solid Front Door / Glass Rear Door Ref 7 = Glass Front Door / Solid Rear Door Ref	0 = 115/60/1 1 = 220/50/1 3 = 208-230/115/60/1	1 = Full 0 = Half	Refer to Price Book or AutoQuotes	Pass Thru (P)	0 = Self Contained	4 = R450A 5 = R448A	3 = LED
G	3	0 = Solid Door Ref 1 = Freezer 2 = Glass Door Ref	0 = 115/60/1 1 = 220/50/1 3 = 208-230/115/60/1	1 = Full 0 = Half	Refer to Price Book or AutoQuotes	Pass Thru (P)	0 = Self Contained	4 = R450A 5 = R448A	3 = LED

R290 G-SERIES REACH-IN MODEL NUMBERS

SERIES (1)	SECTIONS (2)	REFRIGERATOR/FREEZER/HEATED (3)	VOLTAGE (4)	DOOR HEIGHT (5)	HINGING (6)	R290 REFRIGERATION SYSTEM (7)	REFRIGERANT TYPE (8)	LIGHTS (9)
G	1	0 = Solid Door Ref 1 = Glass Door Ref 2 = Freezer 6 = Solid Front Door / Glass Rear Door Ref 7 = Glass Front Door / Solid Rear Door Ref	0 = 115/60/1	0 = Half Reach-In 1 = Full Reach-In 4 = Half Pass-Thru 5 = Full Pass-Thru	Refer to Price Book or AutoQuotes	0 = Self Contained	3 = R290	2 = LED
G	2	0 = Solid Door Ref 1 = Glass Door Ref 2 = Freezer 6 = Solid Front Door / Glass Rear Door Ref 7 = Glass Front Door / Solid Rear Door Ref	0 = 115/60/1	0 = Half Reach-In 1 = Full Reach-In 4 = Half Pass-Thru 5 = Full Pass-Thru	Refer to Price Book or AutoQuotes	0 = Self Contained	3 = R290	2 = LED
G	3	0 = Solid Door Ref 1 = Freezer 2 = Glass Door Ref	0 = 115/60/1 3 = 208-230/115/60/1	0 = Half Reach-In 1 = Full Reach-In	Refer to Price Book or AutoQuotes	0 = Self Contained	3 = R290	2 = LED

STANDARD FEATURES

- Stainless steel exterior
- Stainless steel interior (R-Series)
- Anodized aluminum interior (A-Series)
- Smart Control with LED display
- Self-contained, balanced refrigeration system (refrigerators & freezers) (remote options available)
- Standard operating temperature 34°F to 38°F (refrigerators), 0°F to -5°F (freezers), 135°F to 180°F (hot food cabinets)
- Self-closing door(s) with stay-open feature
- Magnetic snap-in EZ-Clean door gasket(s)
- Automatic non-electric condensate evaporator (refrigerators & freezers)
- StayClear™ condenser standard on most reach-in models
- Three coated shelves per section
- Automatically activated LED lights (incandescent lights on hot food cabinets)
- Stainless steel breaker caps
- Four 6" high adjustable stainless steel legs
- Remote Glycol applications (refrigerator & freezer only, consult factory)
- Wine temperature application option (dual temps, "W" & "N" width models only)
- Lifetime warranty on door hinges & handles
- Three-year parts & labor warranty
- Five-year compressor warranty



RHT132WUT-FHS shown with optional casters



ONE SECTION REACH-IN SOLID DOOR MODELS

WIDTH x DEPTH x HEIGHT	DOOR HEIGHT	REFRIGERATORS	FREEZERS	HOT FOOD	DUAL TEMP
32" x 35" x 83¼"	Full	RHT132EUT-FHS	RLT132EUT-FHS	Consult Factory	N/A
	Half	RHT132EUT-HHS	RLT132EUT-HHS	Consult Factory	Consult Factory
29⅞" x 35" x 83¼"	Full	RHT132WUT-FHS	RLT132WUT-FHS	RHF132W-FHS	N/A
	Half	RHT132WUT-HHS	RLT132WUT-HHS	RHF132W-HHS	RDT132WUT-HHS
29⅞" x 29" x 83¼"	Full	RHT126WUT-FHS	RLT126WUT-FHS	Consult Factory	N/A
	Half	RHT126WUT-HHS	RLT126WUT-HHS	Consult Factory	RDT126WUT-HHS
26⅞" x 35" x 83¼"	Full	RHT132NUT-FHS	RLT132NUT-FHS	Consult Factory	N/A
	Half	RHT132NUT-HHS	RLT132NUT-HHS	Consult Factory	Consult Factory
24" x 35" x 83¼"	Full	RHT132DUT-FHS	RLT132DUT-FHS	Consult Factory	N/A
	Half	RHT132DUT-HHS	RLT132DUT-HHS	Consult Factory	RDT132DUT-HHS

TWO SECTION REACH-IN SOLID DOOR MODELS

WIDTH x DEPTH x HEIGHT	DOOR HEIGHT	REFRIGERATORS	FREEZERS	HOT FOOD	DUAL TEMP
58" x 35" x 83¼"	Full	RHT232WUT-FHS	RLT232WUT-FHS	RHF232W-FHS	RDT232WUT-FHS
	Half	RHT232WUT-HHS	RLT232WUT-HHS	RHF232W-HHS	RDT232WUT-HHS
58" x 29" x 83¼"	Full	RHT226WUT-FHS	RLT226WUT-FHS	Consult Factory	Consult Factory
	Half	RHT226WUT-HHS	RLT226WUT-HHS	Consult Factory	Consult Factory
52⅞" x 35" x 83¼"	Full	RHT232NUT-FHS	RLT232NUT-FHS	Consult Factory	RDT232NUT-FHS
	Half	RHT232NUT-HHS	RLT232NUT-HHS	Consult Factory	RDT232NUT-HHS
48" x 35" x 83¼"	Full	RHT232DUT-FHS	RLT232DUT-FHS	Consult Factory	RDT232DUT-FHS
	Half	RHT232DUT-HHS	RLT232DUT-HHS	Consult Factory	RDT232DUT-HHS

THREE SECTION REACH-IN SOLID DOOR MODELS

WIDTH x DEPTH x HEIGHT	DOOR HEIGHT	REFRIGERATORS	FREEZERS	HOT FOOD	DUAL TEMP
86⅞" x 35" x 83¼"	Full	RHT332WUT-FHS	RLT332WUT-FHS	RHF332W-FHS	RDT332WUT-FHS
	Half	RHT332WUT-HHS	RLT332WUT-HHS	RHF332W-HHS	RDT332WUT-HHS
76⅞" x 35" x 83¼"	Full	RHT332NUT-FHS	RLT332NUT-FHS	Consult Factory	RDT332NUT-FHS
	Half	RHT332NUT-HHS	RLT332NUT-HHS	Consult Factory	RDT332NUT-HHS

All R-Series models are also available in the Traulsen A-Series which is identical to the R-Series, however, the A-Series models are built with an anodized aluminum cabinet interior.

REFRIGERATORS REACH-IN GLASS DOOR MODELS

STANDARD FEATURES

- Stainless steel exterior
- Stainless steel interior (R-Series)
- Anodized aluminum interior (A-Series)
- Smart Control with LED display
- Self-contained, balanced refrigeration system (remote options available)
- Standard operating temperature 34°F to 38°F
- Self-closing door(s) with stay-open feature
- Magnetic snap-in EZ-Clean door gasket(s)
- Lifetime warranty on cam-lift hinges*
- StayClear™ condenser standard (most models)
- Automatic non-electric condensate evaporator
- Three coated shelves per section
- LED lights with exterior switch*
- Vertical metal door handle(s)
- Stainless steel breaker caps*
- Four 6" high adjustable stainless steel legs
- Three-year parts & labor warranty
- Five-year compressor warranty

* Except sliding glass doors



RHT232WUT-HHG
(shown with optional casters)



All R-Series models are also available in the Traulsen A-Series which is identical to the R-Series, however, the A-Series models are built with an anodized aluminum cabinet interior.

ONE SECTION REACH-IN GLASS DOOR MODELS

WIDTH x DEPTH x HEIGHT	DOOR HEIGHT	REFRIGERATORS
29 ⁷ / ₈ " x 35" x 83 ³ / ₄ "	Full	RHT132WUT-FHG
	Half	RHT132WUT-HHG
29 ⁷ / ₈ " x 29" x 83 ³ / ₄ "	Full	RHT126WUT-FHG
	Half	RHT126WUT-HHG
24" x 35" x 83 ³ / ₄ "	Full	RHT132DUT-FHG
	Half	RHT132DUT-HHG

TWO SECTION REACH-IN GLASS DOOR MODELS

WIDTH x DEPTH x HEIGHT	DOOR HEIGHT	REFRIGERATORS
58" x 35" x 83 ³ / ₄ "	Full	RHT232WUT-FHG
	Half	RHT232WUT-HHG
58" x 29" x 83 ³ / ₄ "	Full	RHT226WUT-FHG
	Half	RHT226WUT-HHG
52 ¹ / ₈ " x 35" x 83 ³ / ₄ "	Full	RHT232NUT-FHG
	Half	RHT232NUT-HHG
48" x 35" x 83 ³ / ₄ "	Full	RHT232DUT-FHG
	Half	RHT232DUT-HHG

THREE SECTION REACH-IN GLASS DOOR MODELS

WIDTH x DEPTH x HEIGHT	DOOR HEIGHT	REFRIGERATORS
86 ¹ / ₈ " x 35" x 83 ³ / ₄ "	Full	RHT332WUT-FHG
	Half	RHT332WUT-HHG
76 ⁵ / ₁₆ " x 35" x 83 ³ / ₄ "	Full	RHT332NUT-FHG
	Half	RHT332NUT-HHG

TWO SECTION REACH-IN SLIDING GLASS DOOR MODELS

WIDTH x DEPTH x HEIGHT	DOOR HEIGHT	REFRIGERATORS
58" x 33" x 83 ³ / ₄ "	Full	RHT232WUT-FSL
	Half	RHT232WUT-HSL
52 ¹ / ₈ " x 33" x 83 ³ / ₄ "	Full	RHT232NUT-FSL
	Half	RHT232NUT-HSL

Refrigeration System



By combining balanced, high quality components, precise microprocessor controls and careful construction, our systems cycle less often, and offer the efficiency you're looking for while still providing the outstanding reliability and performance your operation needs.

STANDARD FEATURES

- Stainless steel exterior
- Stainless steel interior (R-Series)
- Anodized aluminum interior (A-Series)
- Smart Control with LED display
- Self-contained, balanced refrigeration system (remote options available)
- Standard operating temperature 34° F to 38° F (refrigerators), 135° F to 180° F (hot food cabinets)
- Self-closing door(s) with stay-open feature
- Magnetic snap-in EZ-Clean door gasket(s)
- StayClear™ condenser standard on most pass-thru models (excludes hot food cabinets)
- Automatic non-electric condensate evaporator (refrigerators only)
- Three coated shelves per section
- Automatically activated LED lights (refrigerators), incandescent lights (hot food cabinets)
- Stainless steel breaker caps
- Four 6" high adjustable stainless steel legs
- Lifetime warranty on door hinges & handles
- Three-year parts & labor warranty
- Five-year compressor warranty (refrigerators only)



RHT332WPUT-FHS



ONE SECTION PASS-THRU MODELS

WIDTH x DEPTH x HEIGHT	DOOR HEIGHT	REFRIGERATORS	HOT FOOD
29 ⁷ / ₈ " x 37 ¹⁵ / ₁₆ " x 83 ³ / ₄ "	Full	RHT132WPUT-FHS	RHF132WP-FHS
	Half	RHT132WPUT-HHS	RHF132WP-HHS
29 ⁷ / ₈ " x 31 ¹⁵ / ₁₆ " x 83 ³ / ₄ "	Full	RHT126WPUT-FHS	N/A
	Half	RHT126WPUT-HHS	N/A

TWO SECTION PASS-THRU MODELS

WIDTH x DEPTH x HEIGHT	DOOR HEIGHT	REFRIGERATORS	HOT FOOD
52 ³ / ₈ " x 37 ¹⁵ / ₁₆ " x 83 ³ / ₄ "	Full	RHT232NPUT-FHS	N/A
	Half	RHT232NPUT-HHS	N/A
58" x 37 ¹⁵ / ₁₆ " x 83 ³ / ₄ "	Full	RHT232WPUT-FHS	RHF232WP-FHS
	Half	RHT232WPUT-HHS	RHF232WP-HHS
58" x 31 ¹⁵ / ₁₆ " x 83 ³ / ₄ "	Full	RHT226WPUT-FHS	Consult Factory
	Half	RHT226WPUT-HHS	Consult Factory

THREE SECTION PASS-THRU MODELS

WIDTH x DEPTH x HEIGHT	DOOR HEIGHT	REFRIGERATORS	HOT FOOD
76 ⁵ / ₁₆ " x 37 ¹⁵ / ₁₆ " x 83 ³ / ₄ "	Full	RHT332NPUT-FHS	N/A
	Half	RHT332NPUT-HHS	N/A
86 ⁷ / ₈ " x 37 ¹⁵ / ₁₆ " x 83 ³ / ₄ "	Full	RHT332WPUT-FHS	RHF332WP-FHS
	Half	RHT332WPUT-HHS	RHF332WP-HHS

Condenser Cleaning



Traulsen locates the condenser coil right behind the lift-up louver panel, facing front, making it so easy to access and clean. Most R&A series models come standard with StayClear™ Condenser Coil which has innovative technology that dramatically reduces blockages and the build-up of dirt, keeping the condenser clear.



Please refer to energystar.gov to view the most up-to-date product listing and performance data.

All R-Series models are also available in the Traulsen A-Series which is identical to the R-Series, however, the A-Series models are built with an anodized aluminum cabinet interior.

STANDARD FEATURES

- Stainless steel exterior
- Stainless steel interior (R-Series)
- Anodized aluminum interior (A-Series)
- Smart Control with LED display
- Self-contained, balanced refrigeration system (remote options available)
- Standard operating temperature 34°F to 38°F (refrigerators), 0°F to -5°F (freezers), 135°F to 180°F (hot food cabinets)
- Self-closing door(s) with stay-open feature
- Magnetic snap-in EZ-Clean door gasket(s)
- Automatic non-electric condensate evaporator
- Maximum rack size:
 “L” height models = 27" w x 29" d x 66" h
 “H” height models = 27" w x 29" d x 72" h
- Stainless steel breaker caps
- Remote Glycol applications (refrigerator & freezer only, consult factory)
- StayClear™ condenser standard (excludes hot food cabinets)
- Lifetime warranty on door hinges & handle(s)
- Three-year parts & labor warranty
- Five-year compressor warranty



RRI132LUT-FHS



ONE SECTION ROLL-IN MODELS

WIDTH x DEPTH x HEIGHT	DOOR HEIGHT	RACKS	REFRIGERATORS	FREEZERS	HOT FOOD
35½" x 35⅝" x 83¼"	Full	66" High	RRI132LUT-FHS	RIF132LUT-FHS	RIH132L-FHS
35½" x 35⅝" x 89⅞"	Full	72" High	RRI132HUT-FHS	RIF132HUT-FHS	RIH132H-FHS

ONE SECTION ROLL-THRU MODELS

WIDTH x DEPTH x HEIGHT	DOOR HEIGHT	RACKS	REFRIGERATORS	FREEZERS	HOT FOOD
35½" x 39⅞" x 83¼"	Full	66" High	RRI132LPUT-FHS	Consult Factory	RIH132LP-FHS

TWO SECTION ROLL-IN MODELS

WIDTH x DEPTH x HEIGHT	DOOR HEIGHT	RACKS	REFRIGERATORS	FREEZERS	HOT FOOD
68" x 35⅝" x 83¼"	Full	66" High	RRI232LUT-FHS	RIF232LUT-FHS	RIH232L-FHS
68" x 35⅝" x 89⅞"	Full	72" High	RRI232HUT-FHS	RIF232HUT-FHS	RIH232H-FHS

TWO SECTION ROLL-THRU MODELS

WIDTH x DEPTH x HEIGHT	DOOR HEIGHT	RACKS	REFRIGERATORS	FREEZERS	HOT FOOD
68" x 39⅞" x 83¼"	Full	66" High	RRI232LPUT-FHS	Consult Factory	RIH232LP-FHS

THREE SECTION ROLL-IN MODELS

WIDTH x DEPTH x HEIGHT	DOOR HEIGHT	RACKS	REFRIGERATORS	FREEZERS	HOT FOOD
100½" x 35⅝" x 83¼"	Full	66" High	RRI332LUT-FHS	RIF332LUT-FHS	RIH332L-FHS
100½" x 35⅝" x 89⅞"	Full	72" High	RRI332HUT-FHS	RIF332HUT-FHS	RIH332H-FHS

THREE SECTION ROLL-THRU MODELS

WIDTH x DEPTH x HEIGHT	DOOR HEIGHT	RACKS	REFRIGERATORS	FREEZERS	HOT FOOD
100½" x 39⅞" x 83¼"	Full	66" High	RRI332LPUT-FHS	Consult Factory	RIH332LP-FHS

 Please refer to energystar.gov to view the most up-to-date product listing and performance data.

All R-Series models are also available in the Traulsen A-Series which is identical to the R-Series, however, the A-Series models are built with an anodized aluminum cabinet interior.

R & A SERIES MODEL NUMBERS

R	HT	2	32	N	P	UT	FHS
(1)	(2)	(3)	(4)	(5)	(6)	(7)	(8)

POSITION (1)

EXTERIOR & INTERIOR METAL FINISH

- R** Stainless Steel Exterior and Interior
- A** Stainless Steel Exterior, Anodized Aluminum Interior

POSITION (2)

TYPE OF CABINET

- HT** Refrigerator (reach-in/pass-thru)
- RI** Refrigerator (roll-in/roll-thru)
- LT** Freezer (reach-in)
- IF** Freezer (roll-in)
- DT** Dual Temp (refrigerator/freezer)
- DH** Dual Temp (refrigerator/heated cabinet)
- HF** Heated Cabinet (reach-in/pass-thru)
- IH** Heated Cabinet (roll-in/roll-thru)
- ET** Even Thaw

POSITION (3)

NUMBER OF CABINET SECTIONS

POSITION (4)

DEPTH OF CABINET BODY IN INCHES

- 32" STANDARD
- 26" SLIM LINE

POSITION (5)

CABINET WIDTH (or roll-in rack height)

- N** 26-3/8" (1-section), 52-1/8" (2-section), 76-5/16" (3-section)
- W** 29-7/8" (1-section), 58" (2-section), 86-1/8" (3-section)
- D** 24" (1-section), 48" (2-section)
- K** 24" (1-section)
- L** Roll-In/Roll-Thru To Accommodate a 66" High Rack
- H** Roll-In/Roll-Thru To Accommodate a 72" High Rack

POSITION (6)

- If P is present, it is a Pass-Thru (or Roll-Thru)
- If P is not present, it is a Reach-In (or Roll-In)

POSITION (7)

- If UT is present, the cabinet is Self-Contained with top-mounted condensing unit.
- If UT is not present in this position, the cabinet is Remote (Condensing unit not furnished) or a heated cabinet.

POSITION (8)

- FHS** = Full-Length Stainless Steel Door(s)
- HHS** = Half-Length Stainless Steel Doors
- FHG** = Full-Length Hinged Glass Door(s)
- HHG** = Half-Length Hinged Glass Doors
- FSL** = Full-Length Sliding Glass Doors
- HSL** = Half-Length Sliding Glass Doors

REFRIGERATORS & FREEZERS COMPACT UNDERCOUNTER MODELS

STANDARD FEATURES

- Stainless steel exterior front, top, sides and door(s)
- Anodized aluminum interior
- Electronic control
- 115/60/1 voltage, self-contained, with cord and plug attached
- Self-closing door(s) with stay-open feature
- Magnetic snap-in EZ-Clean door gasket(s)
- Two powder-coated shelves per door
- 4" high casters
- Automatic, non-electric condensate evaporator
- Three-year parts & labor warranty
- Five-year compressor warranty



UHT60

COMPACT UNDERCOUNTER DOOR MODELS, SELF-CONTAINED

WIDTH x DEPTH x HEIGHT	NUMBER DOORS	REFRIGERATORS	FREEZERS
27" x 30 ⁷ / ₈ " x 33 ¹ / ₂ "	1	UHT27	ULT27
48" x 30 ⁷ / ₈ " x 33 ¹ / ₂ "	2	UHT48	ULT48
60" x 30 ⁷ / ₈ " x 33 ¹ / ₂ "	2	UHT60	ULT60

COMPACT UNDERCOUNTER DRAWER MODELS, SELF-CONTAINED

WIDTH x DEPTH x HEIGHT	NUMBER DRAWERS	REFRIGERATORS
27" x 31 ¹ / ₈ " x 33 ¹ / ₂ "	2	UHT27-D
60" x 31 ¹ / ₈ " x 33 ¹ / ₂ "	4	UHT60-DD

NOTE: All models available with optional R290 refrigerant if needed.

REFRIGERATORS GLASS DOOR COMPACT UNDERCOUNTER MODELS

STANDARD FEATURES

- Stainless steel exterior front, top, sides & glass door(s)
- Anodized aluminum interior
- Electronic control
- 115/60/1 voltage, self-contained, with cord & plug attached
- Self-closing door(s) with stay-open feature
- Magnetic snap-in EZ-Clean door gasket(s)
- Two powder-coated shelves per door on pilasters
- Four 4" high casters
- Automatic, non-electric condensate evaporator
- Three-year parts & labor warranty
- Five-year compressor warranty



UHG48LR-0420

COMPACT UNDERCOUNTER DOOR MODELS, SELF-CONTAINED

WIDTH x DEPTH x HEIGHT	NUMBER DOORS	REFRIGERATORS
48" x 27 ⁷ / ₈ " x 35"	2	UHG48LR-0420
48" x 27 ⁷ / ₈ " x 35"	2	UHG48LL-0420
48" x 27 ⁷ / ₈ " x 35"	2	UHG48RR-0420
48" x 27 ⁷ / ₈ " x 35"	2	UHG48RL-0420

REFRIGERATORS COMPACT PREP TABLE MODELS

STANDARD FEATURES

- Stainless steel exterior front, sides and door(s)
- Stainless steel pan cover with pivoting front lid
- Anodized aluminum interior
- Full compliment of sixth size 4" deep plastic pans and divider bars included
- Reversible, full-length nylon cutting board
- 6" deep pan capacity
- Electronic control
- Meets NSF 7 Standard for prep tables
- 115/60/1 voltage, self-contained, with cord and plug attached
- Self-closing door(s) with stay-open feature
- Magnetic snap-in EZ-Clean door gasket(s)
- Two powder coated shelves per door
- 4" high casters
- Automatic non-electric condensate evaporator
- Three-year parts & labor warranty
- Five-year compressor warranty



UST27 Door Model



COMPACT PREP TABLE DOOR MODELS, SELF-CONTAINED

WIDTH	DEPTH x HEIGHT		REFRIGERATORS	PAN CAPACITY*
	UST MODELS	UPT MODELS		
27"	33 ³ / ₈ " x 37 ⁷ / ₈ "	33 ³ / ₈ " x 42 ³ / ₄ "	UST276 / UPT276	6
27"	33 ³ / ₈ " x 37 ⁷ / ₈ "	33 ³ / ₄ " x 44"	UST279 / UPT279	9
32"	33 ³ / ₄ " x 37 ⁷ / ₈ "	33 ³ / ₄ " x 44"	UST3212 / UPT3212	12
48"	33 ³ / ₈ " x 37 ⁷ / ₈ "	33 ³ / ₄ " x 42 ³ / ₄ "	UST488 / UPT488	8
48"	33 ³ / ₈ " x 37 ⁷ / ₈ "	33 ³ / ₄ " x 42 ³ / ₄ "	UST4812 / UPT4812	12
48"	33 ³ / ₈ " x 37 ⁷ / ₈ "	33 ³ / ₄ " x 44"	UST4818 / UPT4818	18
60"	33 ³ / ₈ " x 37 ⁷ / ₈ "	33 ³ / ₄ " x 42 ³ / ₄ "	UST6012 / UPT6012	12
60"	33 ³ / ₈ " x 37 ⁷ / ₈ "	33 ³ / ₄ " x 44"	UST6024 / UPT6024	24
72"	34 ¹ / ₂ " x 37 ⁷ / ₈ "	34 ¹ / ₂ " x 42 ³ / ₄ "	UST7212 / UPT7212	12
72"	34 ¹ / ₂ " x 37 ⁷ / ₈ "	34 ¹ / ₂ " x 44"	UST7218	18
72"	34 ¹ / ₂ " x 37 ⁷ / ₈ "	34 ¹ / ₂ " x 44"	UST7224 / UPT7224	24
72"	34 ¹ / ₂ " x 37 ⁷ / ₈ "	34 ¹ / ₂ " x 44"	UST7230 / UPT7230	30

* Capacity shown using sixth size pans



UPT60 Door Model

COMPACT PREP TABLE DRAWER MODELS, SELF-CONTAINED

WIDTH	DEPTH x HEIGHT		REFRIGERATORS	PAN CAPACITY
	UST MODELS	UPT MODELS		
27"	34 ¹ / ₂ " x 37 ⁷ / ₈ "	34 ¹ / ₂ " x 42 ³ / ₄ "	UST276-D / UPT276-D	6
27"	34 ¹ / ₂ " x 37 ⁷ / ₈ "	34 ¹ / ₂ " x 44"	UST279-D / UPT279-D	9
32"	34 ¹ / ₂ " x 37 ⁷ / ₈ "	34 ¹ / ₂ " x 44"	UST3212-D / UPT3212-D	12
60"	34 ¹ / ₂ " x 37 ⁷ / ₈ "	34 ¹ / ₂ " x 42 ³ / ₄ "	UST6012-DD / UPT6012-DD	12
60"	34 ¹ / ₂ " x 37 ⁷ / ₈ "	34 ¹ / ₂ " x 44"	UST6024-DD / UPT6024-DD	24
72"	34 ¹ / ₂ " x 37 ⁷ / ₈ "	34 ¹ / ₂ " x 42 ³ / ₄ "	UST7212-DD / UPT7212-DD	12
72"	34 ¹ / ₂ " x 37 ⁷ / ₈ "	34 ¹ / ₂ " x 44"	UST7218-DD	18
72"	34 ¹ / ₂ " x 37 ⁷ / ₈ "	34 ¹ / ₂ " x 44"	UST7224-DD / UPT7224-DD	24
72"	34 ¹ / ₂ " x 37 ⁷ / ₈ "	34 ¹ / ₂ " x 44"	UST7230-DD / UPT7230-DD	30

NOTE: All models available with optional R290 refrigerant if needed.



UST27 Drawer Model

STANDARD FEATURES

- Stainless steel exterior and interior
- Top mounted removable self-contained refrigeration system
- Forced air refrigeration system
- Accomodates 13" x 13" crate(s) 8, 12 or 16 capacity or 13" x 18" crate(s) 4, 6 or 8 capacity
- Single or double access models
- Sliding lift up and down door(s)
- Reinforced cabinet exterior bottom with dunnage rack
- Lockable insulated door(s)
- Electronic control
- Metal door handles
- Magnetic snap-in EZ-Clean gasket(s)
- 9' cord and plug attached
- Set of four (4) 6" or 4" factory mounted adjustable casters (6 for 58" models)
- Three-year parts & labor warranty
- Five-year compressor warranty



RMC49D4



SINGLE ACCESS MILK COOLER MODELS

WIDTH x DEPTH x HEIGHT	CRATE CAPACITY		CASTERS	MILK COOLERS
	13" x 13"	13" x 18"		
34" x 32½" x 46"	8	4	4"	RMC34S4
34" x 32½" x 48"	8	4	6"	RMC34S6
49" x 32½" x 46"	12	6	4"	RMC49S4
49" x 32½" x 48"	12	6	6"	RMC49S6
58" x 32½" x 46"	16	8	4"	RMC58S4
58" x 32½" x 48"	16	8	6"	RMC58S6

DOUBLE ACCESS MILK COOLER MODELS

WIDTH x DEPTH x HEIGHT	CRATE CAPACITY		CASTERS	MILK COOLERS
	13" x 13"	13" x 18"		
34" x 34¼" x 46"	8	4	4"	RMC34D4
34" x 34¼" x 48"	8	4	6"	RMC34D6
49" x 34¼" x 46"	12	6	4"	RMC49D4
49" x 34¼" x 48"	12	6	6"	RMC49D6
58" x 34¼" x 46"	16	8	4"	RMC58D4
58" x 34¼" x 48"	16	8	6"	RMC58D6

STANDARD FEATURES

- Stainless steel front, sides, door(s) and interior
- Microprocessor control with LED display
- Self-contained balanced refrigeration system
- Standard operating temperature 34° F to 38° F
- Automatic, condensate evaporator
- Two coated shelves per section
- Magnetic snap-in EZ-Clean door gasket(s)
- 6" high adjustable stainless steel legs on adjustable channel
- Three-year parts & labor warranty
- Five-year compressor warranty
- All door(s) provided with locks



TU072HT
(shown with optional top and casters)



FULL SIZE UNDERCOUNTER MODELS

WIDTH x DEPTH* x HEIGHT	NUMBER DOORS	REFRIGERATORS
44" x 34" x 34"	1	TU044HT
72" x 34" x 34"	2	TU072HT
100" x 34" x 34"	3	TU100HT

*Standard rear spacer bracket adds 2" to depth

Insulation

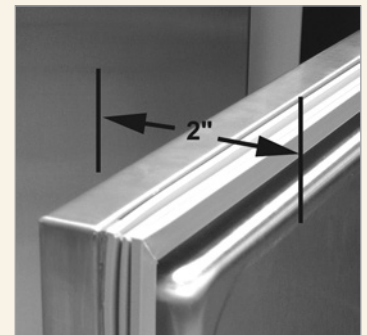

Traulsen insulates the entire cabinet, including the doors, with at least 2" foamed in place insulation. Not only does this provide superior insulating characteristics, but it also adds significant strength to our already rugged design.

REFRIGERATORS & FREEZERS EQUIPMENT STANDS

(Traulsen's Equipment Stands are solely intended for use with cooking equipment.)

STANDARD FEATURES

- Stainless steel exterior and interior
- Stainless steel Marine top
- Microprocessor control with LED display
- Self-contained balanced refrigeration system
- Standard refrigerator operating temperature 34°F to 38°F; standard freezer operating temperature 0°F to -5°F
- Automatic, condensate evaporator
- Self-closing drawers with stay-open feature
- Magnetic snap-in EZ-Clean door gasket(s)
- Accommodates 500 lbs. per section
- Each drawer accommodates 6" deep pans
- 4" high casters on adjustable caster channel
- Three-year parts & labor warranty
- Five-year compressor warranty



TE096HT
(shown with optional compressor on right)



EQUIPMENT STAND MODELS

WIDTH x DEPTH* x HEIGHT	NUMBER DRAWERS	REFRIGERATORS	FREEZERS
36" x 34 $\frac{1}{8}$ " x 26"	2	TE036HT	N/A
48" x 34 $\frac{1}{8}$ " x 26"	2	TE048HT	TE048LT
60" x 34 $\frac{1}{8}$ " x 26"	2	TE060HT	TE060LT
72" x 34 $\frac{1}{8}$ " x 26"	4	TE072HT	TE072LT
84" x 34 $\frac{1}{8}$ " x 26"	4	TE084HT	TE084LT
96" x 34 $\frac{1}{8}$ " x 26"	6	TE096HT	N/A
110" x 34 $\frac{1}{8}$ " x 26"	6	TE110HT	N/A

* Depth overall – including handle

FLEX DRAWER REFRIGERATOR/FREEZER UNDERCOUNTER

STANDARD FEATURES

- Stainless steel exterior top, sides, drawers & interior
- Electronic controls with LED temperature display
- 115/60/1 voltage, self-contained, with cord & plug attached
- Automatic non-electric condensate evaporator
- EZ-Clean drawer gaskets
- Fully removeable abs drawer bins
- Set of four (4) 2.75" casters
- Three-year parts & labor warranty
- Five-year compressor warranty
- Each individual drawer can run at different temperature settings
- Drawer temperature changes from refrigerator to freezer at a touch of a button

FLEX DRAWER UNDERCOUNTER MODEL

WIDTH x DEPTH x HEIGHT	NUMBER DRAWERS	REFRIGERATOR/ FREEZER
30 $\frac{1}{2}$ " x 29 $\frac{1}{16}$ " x 35 $\frac{1}{16}$ "	2	TF031D3



TF031D3





TS048HT
 (shown with optional composite cutting board)



TS072HT



TS090HT

STANDARD FEATURES

- Stainless steel exterior and interior
- 115/60/1 voltage, self-contained, with cord and plug attached
- Microprocessor control with LED display
- Accommodates industry standard full and third size pans without the use of adapter bars
- Two (2) shelves per section
- 6" high casters on adjustable channel mounting system
- All door(s) provided with lock(s)
- Left hand system only
- Self-closing door(s) with stay-open feature
- Gasket-protecting stainless steel door liner
- Temperature rail equipped with drain and flush valve
- Automatic non-electric condensate evaporator
- Three-year parts & labor warranty
- Five-year compressor warranty
- NSF7 Rated for 15 hour top open performance



FULL SIZE PREP TABLE MODELS

WIDTH x DEPTH x HEIGHT	REFRIGERATORS	PAN CAPACITY*
48" x 36" x 48 ³ / ₈ "	TS048HT	6
66" x 36" x 48 ³ / ₈ "	TS066HT	9
72" x 36" x 48 ³ / ₈ "	TS072HT	10
90" x 36" x 48 ³ / ₈ "	TS090HT	12

*Capacity shown using third size pans

"All-Day" Temperature Performance to NSF 7 Test Requirements



Traulsen's full size prep table is equipped with TempAssure™, a specially engineered forced air design which circulates cold air around and underneath the pans as well as lofting a protective blanket over the food surface, effectively insulating it from warm kitchen air.

Customize Your Traulsen Full Size Prep Table with One or More of Our Many Accessories



Ambient Pan Holder



Garnish Rack



Scale Shelf



Cutting Board & Ticket Rail

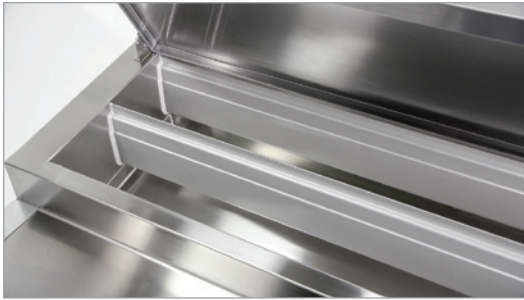

Glycol



TB091SL3S

STANDARD FEATURES

- Glycol system exceeds NSF 7 requirements by maintaining food at or below 39° using specified 8" deep pans 24/7
- Stainless steel exterior & interior finish
- 115/60/1 voltage, self-contained, with cord and plug attached
- Horizontal finned T6 anodized chiller plates, holds 1/3, 1/6, or 1/9 size pans up to 8" deep (pans supplied by others)
- General fit 7.6" chiller bar spacing
- Compressor compartment right side
- Stainless steel lift-off night cover
- Sloped rail
- 14" white poly cutting board (2 row pan rail models)
- 8" white poly cutting board (3 row pan rail models)
- 20" stainless steel door(s), left or right hinge option
- Self-closing door(s) with stay-open feature
- Metal door handle with gasket guard
- Magnetic snap-in door gasket(s)
- Two (2) shelves per section, on pilasters
- Expansion tank
- Heat exchanger and pump closely located from and in communication with refrigeration controls
- Thermostatic expansion valve metering device
- 6" high casters
- 9' cord & plug attached
- Three-year parts & labor warranty
- Five-year compressor warranty



FULL SIZE PREP TABLES, SELF-CONTAINED

WIDTH x DEPTH x HEIGHT	NUMBER DOORS	NUMBER ROWS	REFRIGERATORS	PAN CAPACITY*
46" x 32" x 42"	1	2	TB046SL2S	12
46" x 32" x 42"	1	3	TB046SL3S	18
60" x 32" x 42"	2	2	TB060SL2S	16
60" x 32" x 42"	2	3	TB060SL3S	24
65" x 32" x 42"	2	2	TB065SL2S	18
65" x 32" x 42"	2	3	TB065SL3S	27
71" x 32" x 42"	2	2	TB071SL2S	20
71" x 32" x 42"	2	3	TB071SL3S	30
91" x 32" x 42"	3	2	TB091SL2S	26
91" x 32" x 42"	3	3	TB091SL3S	39
113" x 32" x 42"	4	2	TB113SL2S	32

*Capacity shown using 1/6 size pans

BLAST CHILLERS UNDERCOUNTER, REACH-IN & ROLL-IN / ROLL-THRU

STANDARD FEATURES

- Probe chill auto start
- Four operating modes
- Touch screen control with automatic or manual operation
- USB data exchange
- On-board printers
- Chill by time or temp
- Cycle data stored up to 90 days
- Dual condensing units (excludes TBC5)
- Three removable probes
- Metal breakers
- Lifetime warranty on door hinges & handle(s)
- Three-year parts & labor warranty
- Five-year compressor warranty



UNDERCOUNTER MODELS

WIDTH x DEPTH x HEIGHT	BLAST CHILLERS	TRAY SLIDE LEVELS
54" x 34 ⁷ / ₁₆ " x 33 ³ / ₄ "	TBC5	5

REACH-IN MODELS

WIDTH x DEPTH x HEIGHT	BLAST CHILLERS	TRAY SLIDE LEVELS
41" x 34 ¹ / ₂ " x 74"	TBC13	13

ROLL-IN & ROLL-THRU MODELS

WIDTH x DEPTH x HEIGHT	BLAST CHILLERS	RACK CAPACITY	TYPE
48 ¹ / ₂ " x 37 ⁵ / ₈ " x 90 ³ / ₈ "	TBC1H	1	Roll-In
48 ¹ / ₂ " x 41 ¹ / ₄ " x 90 ³ / ₈ "	TBC1HR	1	Roll-Thru

ROLL-IN & ROLL-THRU MODELS

WIDTH x DEPTH x HEIGHT	BLAST CHILLERS	RACK CAPACITY	TYPE
48 ¹ / ₂ " x 71 ⁵ / ₈ " x 90 ³ / ₈ "	TBC2H	2	Roll-In
48 ¹ / ₂ " x 75 ¹ / ₄ " x 90 ³ / ₈ "	TBC2HR	2	Roll-Thru

NOTE: Traulsen's Blast Chillers are solely intended for blast chilling, and not for use as holding cabinets



TBC5
(shown with optional casters)



TBC13
(shown with optional casters)



TBC1H

QUICK CHILLER UNDERCOUNTER

STANDARD FEATURES

- Stainless steel exterior, front, sides & interior
- Heavy gauge galvanized steel top, back & bottom
- Microprocessor control with LED display
- 115/60/1 voltage, self-contained, with cord and plug attached
- Left hand refrigeration system
- Condenser filter
- Non-electric automatic condensate evaporator
- Operates at 31°F to 35°F
- Two plated shelves on pins
- 6" high legs
- Three-year parts & labor warranty
- Five-year compressor warranty

WIDTH x DEPTH x HEIGHT	QUICK CHILLER
48" x 36" x 34"	TU048QC



TU048QC
(shown with optional casters and stainless steel top)



NOTE: Traulsen's Quick Chillers are solely intended for chilling, and not for use as holding cabinets

REFRIGERATORS REACH-IN, SLIDING GLASS DOOR

STANDARD FEATURES

- Self-closing sliding glass doors with Stay-open feature
- Three coated shelves per section
- Four 6" high stainless steel adjustable legs
- Stainless steel exterior and interior finish
- Smart Control with LED display
- 115/60/1 voltage, self-contained, with cord and plug attached
- LED lights with exterior switch
- Automatic, non-electric condensate evaporator
- Three-year parts & labor warranty
- Five-year compressor warranty

REACH-IN SLIDING GLASS DOOR REFRIGERATOR MODELS

WIDTH x DEPTH x HEIGHT	DOOR HEIGHT	SECTIONS	REFRIGERATORS
52 $\frac{1}{8}$ " x 83 $\frac{1}{4}$ " x 33"	Full	2	RHT232NUT-FSL
52 $\frac{1}{8}$ " x 83 $\frac{1}{4}$ " x 33"	Half	2	RHT232NUT-HSL
58" x 83 $\frac{1}{4}$ " x 33"	Full	2	RHT232WUT-FSL
58" x 83 $\frac{1}{4}$ " x 33"	Half	2	RHT232WUT-HSL



RHT232NUT-FSL
(shown with optional casters)



REFRIGERATORS WINE REFRIGERATOR

STANDARD FEATURES

- Smart Control with LED display
- All metal construction, stainless steel interior and exterior
- 115/60/1 self-contained with cord and plug attached
- LED display hinged glass door(s)
- Self-closing door(s) with stay-open feature & lock(s)
- Magnetic snap-in EZ-Clean door gasket(s)
- Display wine racks (7 per section)
- Set of four 6" high adjustable stainless steel legs
- Three-year parts & labor warranty
- Five-year compressor warranty



Display Wine Racks
Racks can slide out & incline bottles

WINE REFRIGERATOR MODELS – ONE & TWO SECTION

WIDTH x DEPTH x HEIGHT	SECTIONS	DOOR HINGING	REFRIGERATORS
29 $\frac{7}{8}$ " x 26" x 83 $\frac{1}{4}$ "	1	Left	RH126W-WR01
29 $\frac{7}{8}$ " x 26" x 83 $\frac{1}{4}$ "	1	Right	RH126W-WR02
58" x 26" x 83 $\frac{1}{4}$ "	2	Left/Right	RH226W-WR01



RH126W-WR01
(shown with optional casters)

REFRIGERATORS AIR CURTAIN REFRIGERATOR

STANDARD FEATURES

- Stainless steel exterior and interior finish
- Multi-fan 3D air screen system
- Electronic control with two operating modes
- Automatic defrost with manual override feature
- Digital temperature display
- 220/60/1 voltage, self-contained with cord and plug attached
- Ten pairs of tray slides for 18" x 26" pans at 4½" spacing
- Full perimeter bumper
- Vertical door handle & flush mounted side grips on each side
- Rear mounted tubular handle
- Four 6" high casters with stress pads
- One-year parts & labor warranty
- Five-year compressor warranty



RAC37-2

REACH-IN AIR-CURTAIN REFRIGERATOR MODELS

WIDTH x DEPTH x HEIGHT	DOOR HEIGHT	DOOR HINGING	REFRIGERATORS
32" x 37" x 78¾"	Full	Left	RAC37-1
	Full	Right	RAC37-2
	Half	Right	RAC37-18

REFRIGERATORS REACH-IN, EVEN THAW

STANDARD FEATURES

- Reach-in models include 28 Pairs #1 type tray slides (14 per section)
- Four 6" high stainless steel adjustable legs
- Stainless steel exterior and interior finish
- 115/60/1 voltage, self-contained, with cord and plug attached
- Self-closing door(s) with stay-open feature and lock(s)
- Automatic, non-electric condensate evaporator
- Smart Control with LED display
- Lifetime warranty on door handle(s) and hinges
- Three-year parts & labor warranty
- Five-year compressor warranty
- Designed to thaw full loads of frozen food product under safe, temperature controlled conditions



RET232NUT-FHS
(shown with optional casters)

REACH-IN EVEN-THAW REFRIGERATOR MODELS, SELF-CONTAINED

WIDTH x DEPTH x HEIGHT	DOOR HEIGHT	SECTIONS	REFRIGERATORS
32" x 35" x 83¾"	Full	1	RET132EUT-FHS
32" x 35" x 83¾"	Half	1	RET132EUT-HHS
52½" x 35" x 83¾"	Full	1	RET232NUT-FHS
52½" x 35" x 83¾"	Full	1	RET232NUT-HHS

NOTE: Traulsen's even thaw models are solely intended for thawing, and not for use as holding cabinets

STANDARD FEATURES

- R-Series: Stainless steel exterior and interior finish
- A-Series: Stainless steel exterior and anodized aluminum interior
- Smart Control with LED display
- 115/60/1 voltage with cord & plug attached
- LED lights
- Self-closing door(s) with stay-open feature and lock(s)
- Flip a switch to change cabinet from refrigerator to freezer or vice versa
- Magnetic snap-in EZ-Clean door gasket(s)
- Three coated shelves per section on pins
- Four 6" high stainless steel adjustable legs
- Automatic non-electric condensate evaporator
- Guaranteed for life door hinges & handle(s)
- Three-year parts & labor warranty
- Five-year compressor warranty
- R290 refrigerant only



RCV132W-FHS
 (shown with optional casters)

ONE SECTION REACH-IN CONVERTIBLE REFRIGERATOR OR FREEZER MODELS, SELF-CONTAINED

WIDTH x DEPTH x HEIGHT	DOOR HEIGHT	REFRIGERATORS/FREEZERS
29 7/8" x 35" x 83 1/4"	Full	RCV132WUT-FHS
	Half	RCV132WUT-HHS
	Full	ACV132WUT-FHS
	Half	ACV132WUT-HHS

TWO SECTION REACH-IN CONVERTIBLE REFRIGERATOR OR FREEZER MODELS, SELF-CONTAINED

WIDTH x DEPTH x HEIGHT	DOOR HEIGHT	REFRIGERATORS/FREEZERS
58" x 35" x 83 1/4"	Full	RCV232WUT-FHS
	Half	RCV232WUT-HHS
	Full	ACV232WUT-FHS
	Half	ACV232WUT-HHS

STANDARD CORRECTIONAL FEATURES

- Locking hasp(s) to secure contents
- Stainless steel legs with floor mounting holes
- Perforated screen system cover protects system
- Acrylic security cover protects controller
- Welded universal tray slides prevents removal
- Hinges without covers
- Tamper resistant screws secure all components



RH132N-COR01
(Correctional Reach-In Refrigerator)



REFRIGERATOR REACH-IN & PASS-THRU MODELS

WIDTH x DEPTH x HEIGHT	SECTIONS	DOOR HINGING	REFRIGERATORS	TYPE
26 $\frac{3}{8}$ " x 35" x 83 $\frac{3}{4}$ "	1	Left	RH132N-COR01	Reach-In
26 $\frac{3}{8}$ " x 35" x 83 $\frac{3}{4}$ "	1	Right	RH132N-COR02	Reach-In
26 $\frac{3}{8}$ " x 37 $\frac{15}{16}$ " x 83 $\frac{3}{4}$ "	1	FHR/RHR	RH132NP-COR01	Pass-Thru
26 $\frac{3}{8}$ " x 37 $\frac{15}{16}$ " x 83 $\frac{3}{4}$ "	1	FHL/RHL	RH132NP-COR02	Pass-Thru
52 $\frac{1}{8}$ " x 35" x 83 $\frac{3}{4}$ "	2	Left/Right	RH232N-COR01	Reach-In
52 $\frac{1}{8}$ " x 37 $\frac{15}{16}$ " x 83 $\frac{3}{4}$ "	2	FHS/RHS	RH232NP-COR01	Pass-Thru

REFRIGERATOR ROLL-IN & ROLL-THRU MODELS

WIDTH x DEPTH x HEIGHT	SECTIONS	DOOR HINGING	REFRIGERATORS	TYPE
35 $\frac{1}{2}$ " x 35 $\frac{9}{16}$ " x 83 $\frac{3}{4}$ "	1	Left	RR132L-COR01	Roll-In
35 $\frac{1}{2}$ " x 35 $\frac{9}{16}$ " x 83 $\frac{3}{4}$ "	1	Right	RR132L-COR02	Roll-In
35 $\frac{1}{2}$ " x 39 $\frac{1}{8}$ " x 83 $\frac{3}{4}$ "	1	FHR/RHR	RR132LP-COR01	Roll-Thru
35 $\frac{1}{2}$ " x 39 $\frac{1}{8}$ " x 83 $\frac{3}{4}$ "	1	FHL/RHL	RR132LP-COR02	Roll-Thru
68" x 35 $\frac{9}{16}$ " x 83 $\frac{3}{4}$ "	2	Left/Right	RR232L-COR01	Roll-In
68" x 39 $\frac{1}{8}$ " x 83 $\frac{3}{4}$ "	2	FHS/RHS	RR232LP-COR01	Roll-Thru

FREEZER REACH-IN MODELS

WIDTH x DEPTH x HEIGHT	SECTIONS	DOOR HINGING	FREEZERS	TYPE
26 $\frac{3}{8}$ " x 35" x 83 $\frac{3}{4}$ "	1	Left	RL132N-COR01	Reach-In
26 $\frac{3}{8}$ " x 35" x 83 $\frac{3}{4}$ "	1	Right	RL132N-COR02	Reach-In
52 $\frac{1}{8}$ " x 35" x 83 $\frac{3}{4}$ "	2	Left/Right	RL232N-COR01	Reach-In

HOT FOOD HOLDING REACH-IN & PASS-THRU MODELS

WIDTH x DEPTH x HEIGHT	SECTIONS	DOOR HINGING	REFRIGERATORS	TYPE
29 $\frac{7}{8}$ " x 35" x 83 $\frac{3}{4}$ "	1	Left	RW132W-COR01	Reach-In
29 $\frac{7}{8}$ " x 35" x 83 $\frac{3}{4}$ "	1	Right	RW132W-COR02	Reach-In
29 $\frac{7}{8}$ " x 37 $\frac{15}{16}$ " x 83 $\frac{3}{4}$ "	1	FHR/RHR	RW132WP-COR01	Pass-Thru
29 $\frac{7}{8}$ " x 37 $\frac{15}{16}$ " x 83 $\frac{3}{4}$ "	1	FHL/RHL	RW132WP-COR02	Pass-Thru
58" x 35" x 83 $\frac{3}{4}$ "	2	Left/Right	RW232W-COR01	Reach-In
58" x 37 $\frac{15}{16}$ " x 83 $\frac{3}{4}$ "	2	FHS/RHS	RW232WP-COR01	Pass-Thru

HOT FOOD HOLDING ROLL-IN & ROLL-THRU MODELS

WIDTH x DEPTH x HEIGHT	SECTIONS	DOOR HINGING	REFRIGERATORS	TYPE
35 $\frac{1}{2}$ " x 35 $\frac{9}{16}$ " x 83 $\frac{3}{4}$ "	1	Left	RI132L-COR01	Roll-In
35 $\frac{1}{2}$ " x 35 $\frac{9}{16}$ " x 83 $\frac{3}{4}$ "	1	Right	RI132L-COR02	Roll-In
35 $\frac{1}{2}$ " x 39 $\frac{1}{8}$ " x 83 $\frac{3}{4}$ "	1	FHR/RHR	RI132LP-COR01	Roll-Thru
35 $\frac{1}{2}$ " x 39 $\frac{1}{8}$ " x 83 $\frac{3}{4}$ "	1	FHL/RHL	RI132LP-COR02	Roll-Thru
68" x 35 $\frac{9}{16}$ " x 83 $\frac{3}{4}$ "	2	Left/Right	RI232L-COR01	Roll-In
68" x 39 $\frac{1}{8}$ " x 83 $\frac{3}{4}$ "	2	FHS/RHS	RI232LP-COR01	Roll-Thru

STANDARD CORRECTIONAL FEATURES

- Locking hasp(s) to secure contents
- Stainless steel flanged legs prevents tipping over
- Perforated screen system cover protects system
- Acrylic security cover protects controller
- Welded universal tray slides prevents removal
- Hinges without covers
- Tamper resistant screws secures all components



TBC13-COR01
(shown with optional casters)



TBC1H-COR01

Correctional features not shown on either model

BLAST CHILLER MODELS

WIDTH x DEPTH x HEIGHT	SECTIONS	DOOR HINGING	REFRIGERATORS	TYPE
34" x 41½" x 80½"	1	Left	TBC13-COR01	Reach-In
48½" x 37½" x 89½"	1	Left	TBC1H-COR01	Roll-In
48½" x 41½" x 89½"	1	Left	TBC1HR-COR01	Roll-Thru
48½" x 41½" x 89½"	1	Right	TBC1HR-COR02	Roll-Thru

Standard Features for all Correctional Application Models



Locking Hasp



Flanged Legs

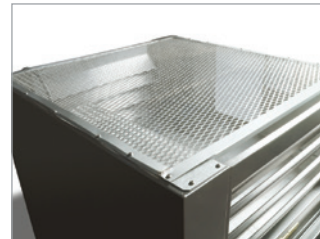

Security System
Perforated Top Cover



Security Acrylic Cover



Welded Tray Slices
(Reach-In/Pass-Thru Models Only)
(12 pairs per section)



Hinges without Covers



Security Screws

Featuring the industry's first **THREE-YEAR PARTS & LABOR WARRANTY** on all units



EZ-Open Foot Pedal

Press-and-Go Convenience

This ergonomically-friendly option, is offset from the door and positioned close to the floor. To open your cabinet, simply press the pedal with the ball of your foot.

By adding the EZ-Open Foot Pedal to your cabinet, you can:

Reduce Spills – Product can be secured with both hands minimizing the possibility of contact with a moving door.

Support Sanitation Efforts – Fewer spills reduce the possibility of cross-contamination. Reduces contact with frequently touched door handles.

Enjoy Ease of Access – EZ-Open Foot Pedal compliments our standard stay-open door feature.



EZ-Clean Gasket

Fits most hot and cold Traulsen units. Our gasket works with your team supporting food quality and safety.

The EZ-Clean Gasket in your Traulsen unit:

Supports Sanitation Efforts – Unlike others available on the market, the EZ-Clean Gasket has a one fold or “bellow” design, which facilitates finding and eliminating dirt and mold.

Saves Time and Effort – Quick cleaning with just the use of sanitizer and a wash cloth. No additional tools required.

Reduces Replacement Costs – Independent lab testing indicates a lifespan increase of at least 50% over standard PVC gaskets.



EZ-Change Interiors

With this option, pilasters can quickly and easily be placed over your unit's side-mounted shoulder screws and moved into place . . . by hand and without tools. The stainless steel tray slides simply drop into labeled grooves to ensure proper alignment.

By adding the EZ-Change Interiors to your unit, you can:

Enjoy Time-Saving Versatility – Quick, no-tools reconfiguration helps you create the space you need, when you need it.

Support Sanitation Efforts – All pilasters are dishwasher-safe.



StayClear™ Condenser

Standard on most R & A models.

Enjoy Ease of Maintenance – Without fins, dust and dirt have virtually no surface area to cling to making regular coil cleanings unnecessary.

Preserve Factory Performance – Compressors work harder when air flow is inhibited by dirty condenser coils. StayClear™ Condenser Coils facilitate ample air flow passage into the condenser while extending your compressor's life.



Tray Slides



Kool Klad Decor



Correctional Application



Additional Shelves



Drawers in Lieu of Doors



Flanged Legs

Options for R & A Series Reach-In/Pass-Thru

Additional Plated Shelves

Add up to a total of nine plated shelves (8 on half-door models) per section on pins (except 1-section dual-temp models), and up to 13 (12 on half-door models) if mounted on optional pilasters at 4" spacing.

Stainless Steel Shelves

Ideal for when jobsite conditions require an alternative to standard plated shelves.

#1 Tray Slides

16 gauge stainless steel angle type tray slides for bottom support of either one 18" x 26" pan or two 14" x 18" pans.

#4 Tray Slides

Plated steel rod type tray slides mounted on a steel frame for rim support of 18" x 26" pans. **Each pair can accommodate a maximum of 18 pans at 1-1/2" increments**, and equips one half cabinet section (actual pan capacities may vary depending upon cabinet type and door size).

Universal Tray Slides

16 gauge steel angle type tray slides for bottom support of one 18" x 26", two 14" x 18" or two 12" x 20" pans.

Reach-In Drawers

Replace the bottom half door with two or three drawers for convenient pan storage on freezers.

6" or 4⁵/₈" High Casters

Set of four, plate type casters, two with locks, mount easily at the bottom of any Traulsen reach-in or pass-thru model, allowing them to be moved on-site for easy cleaning underneath.

Locking Hasp(s)

Available in both single or double styles (depending upon model and door hinging), allows you to secure your valuable foodstuff with a simple padlock.

Kool Klad Laminate Decor

Match your kitchen decor from among the many colors of the Wilsonart® rainbow (other manufacturer's laminates also available).

6" High Flanged Legs

Allows your Traulsen model to be secured to the floor, when required for seismic and marine applications.

Correctional Application Package

Combines several features to secure cabinet for use in a corrections facility.

Options for TU & TE Models

Flat Stainless Steel Top

Provides a flat work surface on top of any full-size undercounter. Note that an optional stainless steel top is required if it is being used to support equipment weighing in excess of 100 lbs. or producing heat in excess of 140°F to the top surface. Similar tops with either a Drip Guard Edge or Backsplash are also available. Equipment stand models are supplied standard with a stainless steel marine top with drip guard edge.

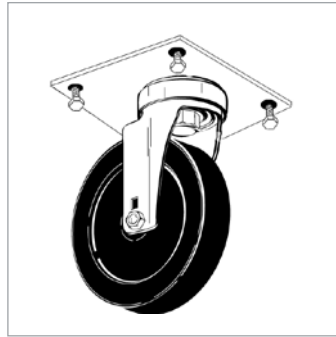
**Drawers In Lieu Of Doors****6" High Casters or Legs****6" Cabinet Extension Section****Flat Stainless Steel Top****Single Locking Hasp****Special Roll-In Rack for TBC1H & TBC2H****Stainless Steel Back**

Provides a finished look for any full-size undercounter or equipment stand when not placed against a wall.

Cabinet Extension Sections

Allows you to extend the width of your equipment stand by 6".

Drawers In Lieu of Doors

Full-size undercounters can be modified to replace one door with two or three drawers.

Doors In Lieu of Drawers

Equipment stand models can be modified to replace two drawers with one door.

#1 Tray Slides

16 gauge stainless steel angle type tray slides for bottom support of either one 18" x 26" pan or two 14" x 18" pans.

Additional Plated Shelves**Universal Tray Slides**

16 gauge steel angle type tray slides for bottom support of one 18" x 26", two 14" x 18" or two 12" x 20" pans.

6" High Casters

Set of six or eight, plate type casters, half with locks, mount easily at the bottom of any Traulsen full-size undercounter, allowing them to be moved on-site for easy cleaning underneath.

Options for Blast Chill Models**Condensate Evaporator Kits**

Choose from 208V bottom-mounted (model TBC13 only) and 115V floor mounted (models TBC1H, TBC1HR, TBC2H and TBC2HR only).

Stainless Steel Back for TBC5**Special Roll-In Rack for TBC1HR & TBC2HR**

Purchase a rack specifically designed to facilitate the air-flow pattern of your Traulsen roll-in or roll-thru blast chiller. Accommodates twenty-six 12" x 20", thirteen 18" x 26" or twenty-six 14" x 18" pans.

Options for TS Series – Full Size Prep Table Models**Cutting Boards**

Choose your prep surface—composite wood or white vinyl. Both board materials are the highest quality, durable and easy to clean.

Shelf for Scale

Ideal when what you're putting together calls for more precise food measurement.

Over Shelf

It's the perfect place to keep spices and other non-refrigerated ingredients within easy reach.

Garnish Rack

Using our optional garnish rack, give your food that final touch without getting your work surface dirty.

TRAY SLIDES

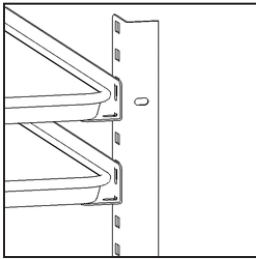

#1 TRAY SLIDES
STANDARD

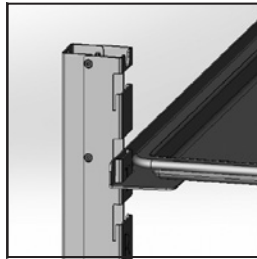

EZ-CHANGE
TRAY SLIDES

#1 TRAY SLIDES
EZ-CHANGE

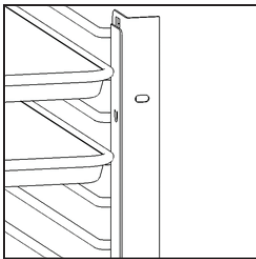

#4 TRAY SLIDES
STANDARD

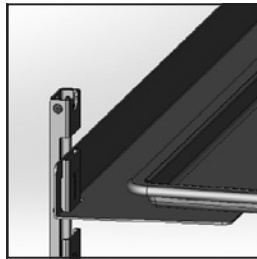

UNIVERSAL TRAY SLIDES
EZ-CHANGE

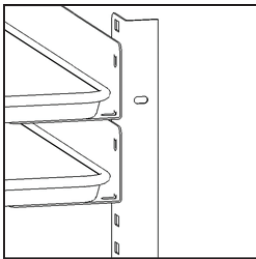

UNIVERSAL TRAY SLIDES
STANDARD

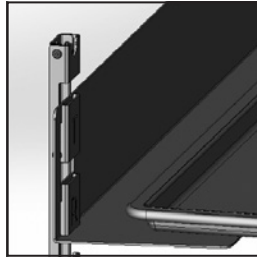

HEAVY-DUTY
UNIVERSAL TRAY SLIDES
EZ-CHANGE

TRAY SLIDES

DESCRIPTION	SPACING			
#1 TRAY SLIDES – STANDARD				
16 ga. stainless steel angle type for bottom support of: (1) 18" x 26" Pan or (2) 14" x 18" Pans	2"	3"	4"	5"
Behind full height door – all models	28	19	14	11
Behind upper half height door – all models	13	9	7	5
Behind lower half height door – all models	13	9	7	5
Behind TU Series undercounter door	9	6	5	4
#1 Tray Slides – EZ-Change Interior				
	2"	4"		
Behind full height door – all models	26	13		
Behind half height door – all models	12	6		
#4 TRAY SLIDES – STANDARD				
Plated steel rod type for rim support of: (1) 18" x 26" Pan (One pair of #4 tray slides accommodates one half section)	1-1/2"			
Behind full height door – all models	38			
Behind upper half height door – all models	18			
Behind lower half height door – all models	18			
UNIVERSAL TRAY SLIDES – STANDARD				
16 ga. stainless steel angle type for bottom support of: (1) 18" x 26" Pan or (2) 14" x 18" Pans or (2) 12" x 20" Pans (For heated cabinets reduce available number of tray slides by 1 (full door and the upper section of a half-door))	4"	5"	6"	
Behind full height door – all models	14	11	9	
Behind upper half height door – all models	6	5	4	
Behind lower half height door – all models	7	5	4	
Behind TU Series undercounter door	5	4	3	
Universal Tray Slides – EZ-Change Interior* (For heated cabinets reduce available number of tray slides by 1 (full door and the upper section of a half-door))				
	2-1/4"		4-1/2"	
Behind full height door – all models	22		11	
Behind half height door – all models	11		5	
Heavy-Duty Universal Tray Slides – EZ-Change Interior* (For heated cabinets reduce available number of tray slides by 1 (full door and the upper section of a half-door))				
	4-1/2"		9"	
Behind full height door – all models	10		5	
Behind half height door – all models	5		2	

NOTES:

- For all after market parts call Traulsen parts department 800-825-8220.
- All 26" deep models are available with shelves only, optional tray slides are not available.
- Deduct one tray slide per door from the above quantities for sliding glass door models.
- Please consult factory for special interior arrangements on "DUT" 24" and 48" wide models.
- Universal tray slides are not available for one, two and three section "N" width models supplied with LED display lights.
- Tray slides are not available for one and two section "D-Width" models supplied with optional LED lights.
- EZ-Change Interior Universal Tray Slides max weight 75 lbs. EZ-Change Heavy-Duty Universal Tray Slides max weight 125 lbs.*
- All tray slides and shelves are factory installed.
- Reduce tray slide quantity by 1 for 1 section Dual Temp.

SHELVES (SOME SHELVES ARE NOT AVAILABLE FOR HEATED CABINETS)

CAPACITY	STD.	MAX.
Behind full height door mounted on standard shelf pins	3	9
Behind half height door mounted on standard shelf pins	3	8
Behind full height door mounted on optional pilasters	3	13 (4" spacing)
Behind half height door mounted on optional pilasters	3	12 (4" spacing)
Behind TU Series undercounter door	2	3

U.S. DOMESTIC WARRANTY (V. 100215)

For sales of Traulsen refrigeration equipment ("Equipment") within the United States, Traulsen warrants to the original purchaser of the Equipment ("Purchaser") that Traulsen will convey the Equipment free and clear of all liens, security interests, and encumbrances created by, through or under Traulsen. Traulsen further warrants that for a period of three (3) years from the later of either (a) the date of delivery to the common carrier or (b) the date of installation (the "Domestic Warranty Period") but in no event, shall the Domestic Warranty Period commence later than 3 months from the date of delivery to the common carrier unless otherwise agreed upon by the parties in writing, under normal use and given proper installation and maintenance as determined by Traulsen, the Equipment: (a) will conform to the specifications as provided by Traulsen ("Specifications") and (b) will be free from substantial defects in material and workmanship.

The warranty period for compressors shall extend for an additional two (2) years beyond the Domestic Warranty Period. In the case of a nonconforming compressor, Traulsen shall provide a replacement compressor; however, all installation, recharging, and repair costs shall be the responsibility of Purchaser. In the case of a nonconforming part, Purchaser must return the part to Traulsen within 30 days from the date of repair. Failure to return a claimed defective part to Traulsen within the 30 days will waive the right to the warranty claim.

Additionally, Traulsen provides a lifetime warranty on the housing of cam-lift hinges and the workflow handles. In the case of a non-conforming housing for cam-lift hinge or workflow handle, Traulsen shall provide a replacement part; however, Purchaser shall be responsible for any other replacement costs, including but not limited to installation and labor.

The Domestic Warranty does not apply to: (a) consumable components or ordinary wear items; (b) components that are removable without the use of tools including but not limited to gaskets, shelf pins, and light bulbs; (c) use of the Equipment components or parts not supplied by Traulsen or specified by Traulsen in the Operator's Manual as set forth on Traulsen's website; or (d) damage resulting from fire, water, burglary, accident, abuse, misuse, transit, acts of God, terrorism, power surges, improper installation, or repairs or installation by unauthorized third parties. Additionally, the Equipment is intended only for commercial use and should not be used by consumers or households or in any non-commercial application. This Domestic Warranty does not apply to, and shall not cover, any Equipment that is installed or used in any way in any residential or non-commercial application. No warranties, express or implied, are provided to any residential, consumer or non-commercial purchaser or owner of the Equipment.

For Traulsen units purchased for use with a condenser provided by a third-party, this standard warranty will apply only to those components contained within the unit to the point of connection of the refrigeration lines leading to the third-party condenser.

In the event of a breach of the warranties set forth above (the "Domestic Warranty"), Traulsen will, at Traulsen's option and as Purchaser's sole remedy, repair or replace, including labor costs, any nonconforming Equipment, provided that (a) during the Warranty Period Traulsen is promptly notified in writing upon discovery of the nonconformance with a detailed explanation of any alleged deficiencies; (b) Traulsen is given a reasonable opportunity to investigate all claims; and (c) Traulsen's examination of any alleged defective part confirms such alleged deficiencies and that the deficiencies were not caused by misuse, neglect, improper installation, unauthorized alteration or repair or improper testing. Traulsen reserves the right to, at its request, require Purchaser shall ship the alleged defective part to Traulsen for inspection and confirmation of defect. No Equipment may be returned without Traulsen's approval.

Purchaser is solely responsible for determining if Equipment is fit for a particular purpose and suitable for Purchaser's application. Accordingly, and due to the nature and manner of Traulsen's Equipment, Traulsen is not responsible for the results or consequences of use, misuse, or application of its Equipment.

THIS DOMESTIC WARRANTY SETS FORTH THE EXTENT OF TRAUlsen'S LIABILITY FOR SALES WITHIN THE UNITED STATES. EXCEPT AS SET FORTH ABOVE, TRAUlsen MAKES NO WARRANTY OR REPRESENTATION OF ANY KIND, EXPRESS OR IMPLIED (INCLUDING NO WARRANTY OF MERCHANTABILITY OR FITNESS FOR ANY PARTICULAR PURPOSE). IN NO EVENT WILL TRAUlsen'S LIABILITY IN CONNECTION WITH THE AGREEMENT OR SALE OF THE EQUIPMENT EXCEED THE PURCHASE PRICE OF THE EQUIPMENT AS TO WHICH THE CLAIM IS MADE. IN NO EVENT SHALL TRAUlsen BE LIABLE FOR ANY LOSS OF USE, LOSS OF PRODUCT, LOSS OF PROFIT, OR ANY OTHER INDIRECT, INCIDENTAL, SPECIAL, OR CONSEQUENTIAL DAMAGES RESULTING FROM THIS WARRANTY EVEN IF TRAUlsen HAS BEEN NOTIFIED OF THE POSSIBILITY OF SUCH DAMAGES.

EXPORT WARRANTY (v. 100215)

For sales of Traulsen refrigeration equipment ("Equipment") outside of the United States, Traulsen warrants parts only, not labor to the original purchaser of the Equipment ("Purchaser") that Traulsen will convey the Equipment free and clear of all liens, security interests and encumbrances created by, through or under Traulsen. Traulsen further warrants that for a period of one (1) year from the date of delivery to the common carrier (the "Export Warranty Period") unless otherwise agreed upon by the parties in writing, under normal use and given proper installation and maintenance as determined by Traulsen, the Equipment: (a) will conform to the Specifications as provided by Traulsen; and (b) will be free from substantial defects in material and workmanship. It is the end user's responsibility to arrange for the export shipping.

The Export Warranty does not apply to: (a) consumable components or ordinary wear items; (b) components that are removable without the use of tools including but not limited to gaskets, shelf pins, and light bulbs; (c) use of the Equipment components or parts not supplied by Traulsen or specified in the Operator's Manual as set forth on Traulsen's website; or (d) damage resulting from fire, water, burglary, accident, abuse, misuse, transit, acts of God, terrorism, power surges, improper installation, or repairs or installation by unauthorized third parties.

For Traulsen units purchased with a condenser provided by a third-party other than Traulsen, this standard warranty will apply only to those components contained within the unit to the point of connection of the refrigeration lines leading to the to the third-party condenser.

In the event of a breach of the warranties set forth above (the "Export Warranty"), Traulsen will, at Traulsen's option and as Purchaser's sole remedy, repair or replace, but not including labor, freight, export costs, packaging costs, any nonconforming Equipment, provided that (a) during the Export Warranty Period Traulsen is promptly notified in writing upon discovery of such nonconformance with a detailed explanation of any alleged deficiencies; (b) Traulsen is given a reasonable opportunity to investigate all claims; and (c) Traulsen's examination of such piece of Equipment defective part confirms the alleged nonconformity and that the nonconformities were not caused by misuse, neglect, improper installation, unauthorized alteration or repair or improper testing. Traulsen reserves the right to, at its request, require Purchaser shall ship the alleged defective part to Traulsen for inspection and confirmation of defect. No Equipment may be returned without Traulsen's approval.

Purchaser is solely responsible for determining if Equipment is fit for a particular purpose and suitable for Purchaser's application. Accordingly and due to the nature and manner of Traulsen's Equipment, Traulsen is not responsible for the results or consequences of use, misuse, or application of its Equipment.

THIS EXPORT WARRANTY SETS FORTH THE EXTENT OF TRAUlsen'S LIABILITY FOR SALES OUTSIDE THE UNITED STATES. EXCEPT AS SET FORTH ABOVE, TRAUlsen MAKES NO WARRANTY OR REPRESENTATION OF ANY KIND, EXPRESS OR IMPLIED (INCLUDING NO WARRANTY OF MERCHANTABILITY OR FITNESS FOR ANY PARTICULAR PURPOSE). IN NO EVENT WILL TRAUlsen'S LIABILITY IN CONNECTION WITH THE AGREEMENT OR SALE OF THE EQUIPMENT EXCEED THE PURCHASE PRICE OF THE EQUIPMENT AS TO WHICH THE CLAIM IS MADE. IN NO EVENT SHALL TRAUlsen BE LIABLE FOR ANY LOSS OF USE, LOSS OF PRODUCT, LOSS OF PROFIT, OR ANY OTHER INDIRECT, INCIDENTAL, SPECIAL, OR CONSEQUENTIAL DAMAGES RESULTING FROM THIS WARRANTY EVEN IF TRAUlsen HAS BEEN NOTIFIED OF THE POSSIBILITY OF SUCH DAMAGES.