



Top Mount Reach-In Refrigerators

MODELS:

MBF8004GR / MBF8005GR / MBF8006GR

Standard Features

- Top mount compressor with environmentally friendly R290 refrigerant
- Stainless steel exterior & interior
- Dixell digital controller
- Maintains temperatures between -33°F – 40°F
- LED interior light(s)
- Recessed door handle(s)
- Door lock(s) standard
- Magnetic door gasket(s) standard for positive door seal
- Pre-installed casters
- Three(3) pre-installed shelves per section
- Down duct refrigeration to ensure even distribution of air



MBF8004GR



MBF8005GR



MBF8006GR

Optional Accessories

- Extra shelves – includes 4 shelf clips per shelf
MBF8004GR shelf part #: W0402389
MBF8005GR shelf part #: W0402385
MBF8006GR shelf part #: W0402385 left/right shelf, part #: W0402386 middle shelf

For the best results of food preservation we recommend setting your refrigerator between 33 °F to 38 °F

1. Don't forget to leave the unit some room to breathe!
2. Please clean the condenser frequently to give the unit more fresh air.



2 YEAR PARTS AND LABOR WARRANTY (US ONLY)
5 YEAR COMPRESSOR PART WARRANTY (US ONLY)



For confirmation and updates on the latest energy star models, please visit energystar.gov



SPECIFICATIONS

Models	Door	Capacity (Cu.Ft.)	Shelves	Casters (inch)	Amps (A)	Voltage (V/Hz/Ph)	HP	Refrigerant	Exterior Dimensions (inch)	Net Weight (lbs)	Gross Weight (lbs)
MBF8004GR	1	21.4	3	4	2.1	115/60/1	1/7	R290	28 ^{7/10} ×31 ^{7/10} ×81 ^{3/10}	220	254
MBF8005GR	2	43.2	6	4	3.2	115/60/1	1/5	R290	51 ^{7/10} ×31 ^{7/10} ×81 ^{3/10}	340	390
MBF8006GR	3	64.9	9	4	4.2	115/60/1	1/4	R290	77 ^{4/5} ×31 ^{7/10} ×81 ^{3/10}	472	551

PLAN VIEW

MBF8004GR

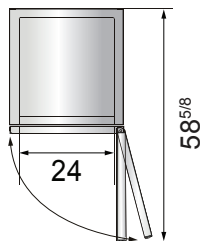
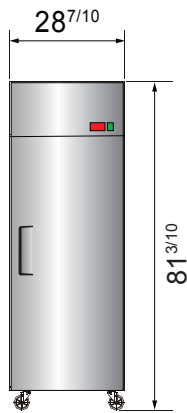

MBF8005GR

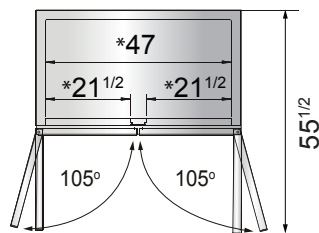
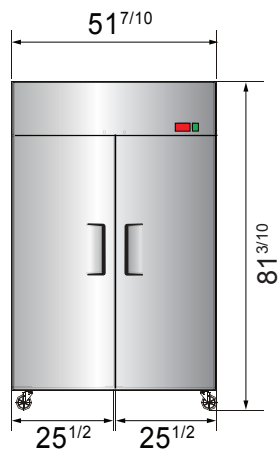

MBF8006GR

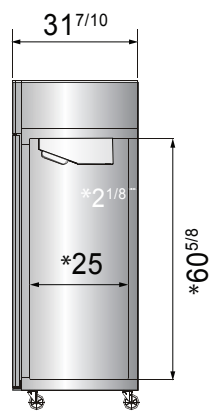
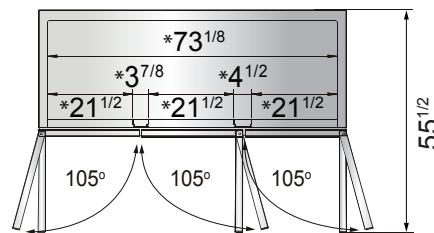
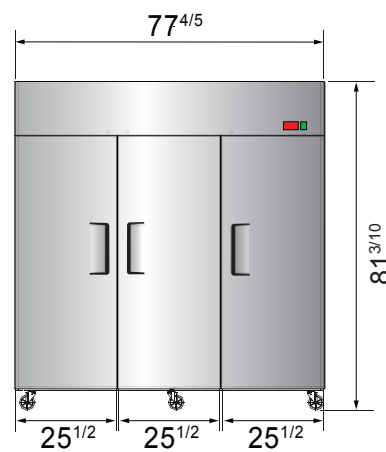

*Interior Dimensions

SELF-CLOSING AND STAY OPEN DOOR FEATURE

Casters

Epoxy shelves

Door lock

Down duct

Temperature control

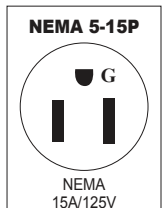



Top Mount Reach-In Freezers

MODELS:

MBF8001GR / MBF8002GR / MBF8003GR

Standard Features

- Top mount compressor with environmentally friendly R290 refrigerant
- Stainless steel exterior & interior
- Dixell digital controller
- Maintains temperatures between -8°F – 0°F
- LED interior light(s)
- Recessed door handle(s)
- Door lock(s) standard
- Magnetic door gasket(s) standard for positive door seal
- Pre-installed casters
- Three(3) pre-installed shelves per section
- Down duct refrigeration to ensure even distribution of air



MBF8001GR



MBF8002GR



MBF8003GR

Optional Accessories

- Extra shelves – includes 4 shelf clips per shelf
MBF8001GR shelf part #: W0402389
MBF8002GR shelf part #: W0402385
MBF8003GR shelf part #: W0402385 left/right shelf, part #: W0402386 middle shelf



MBF8001GR

MBF8002GR

For the best results of food preservation we recommend setting your freezer between -8 °F to 0 °F

1. Don't forget to leave the unit some room to breathe!
2. Please clean the condenser frequently to give the unit more fresh air.



2 YEAR PARTS AND LABOR WARRANTY (US ONLY)
5 YEAR COMPRESSOR PART WARRANTY (US ONLY)



For confirmation and updates on the latest energy star models, please visit energystar.gov



SPECIFICATIONS

Models	Door	Capacity (Cu.Ft.)	Shelves	Casters (inch)	Amps (A)	Voltage (V/Hz/Ph)	HP	Refrigerant	Exterior Dimensions (inch)	Net Weight (lbs)	Gross Weight (lbs)
MBF8001GR	1	21.4	3	4	6.3	115/60/1	1/2	R290	28 ^{7/10} ×31 ^{7/10} ×81 ^{3/10}	236	269
MBF8002GR	2	43.2	6	4	8.6	115/60/1	3/4	R290	51 ^{7/10} ×31 ^{7/10} ×81 ^{3/10}	353	403
MBF8003GR	3	64.9	9	4	6.2	208-230/115/60/1	1	R290	77 ^{4/5} ×31 ^{7/10} ×81 ^{3/10}	489	569

PLAN VIEW

MBF8001GR

MBF8002GR

MBF8003GR

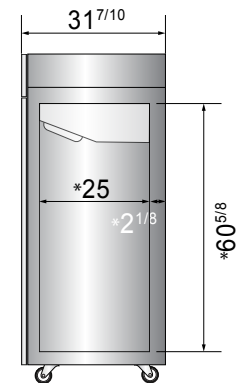
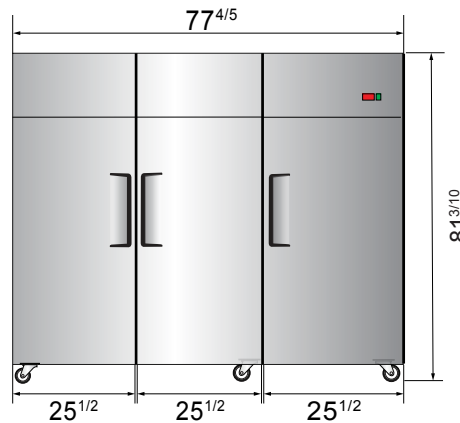
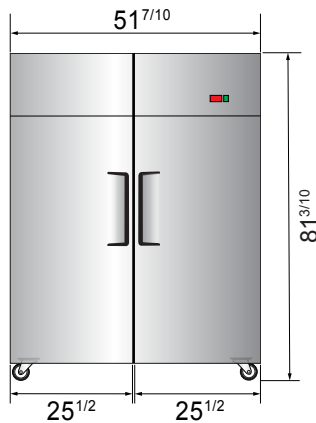
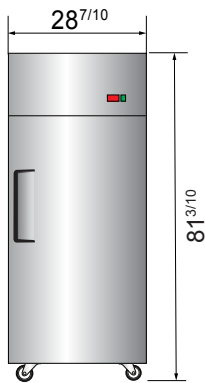

*Interior Dimensions

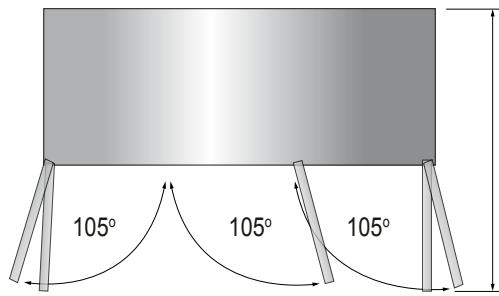
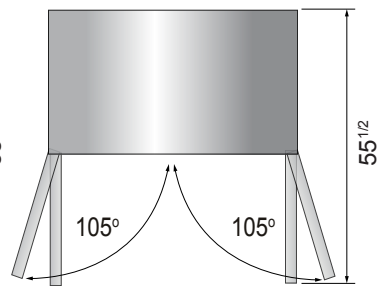
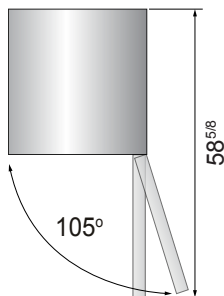

SELF-CLOSING AND STAY OPEN DOOR FEATURE

Casters

Epoxy shelves

Door lock

Down duct

Temperature control

MBF8003GR

MBF8001GR
MBF8002GR

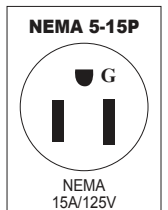
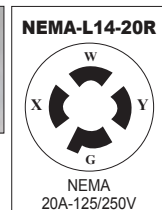



Bottom Mount Reach-In Refrigerators

MODELS:

MBF8505GR / MBF8507GR / MBF8508GR

Standard Features

- Bottom mount compressor units with environmentally friendly R290 refrigerant
- Stainless steel exterior & interior
- Dixell digital controller
- Maintains temperatures between 33°F – 40°F
- LED interior light(s)
- Recessed door handle(s)
- Door lock(s) standard
- Magnetic door gasket(s) standard for positive door seal
- Pre-installed casters
- Three(3) pre-installed shelves per section
- Down duct refrigeration to ensure even distribution of air



MBF8505GR



MBF8507GR



MBF8508GR

Optional Accessories

- Extra shelves – includes 4 shelf clips per shelf
MBF8505GR shelf part #: W0402393
MBF8507GR shelf part #: W0402387
MBF8508GR shelf part #: W0402387 left/right shelf, part #: W0402388 middle shelf

For the best results of food preservation we recommend setting your refrigerator between 33 °F to 38 °F

1. Don't forget to leave the unit some room to breathe!
2. Please clean the condenser frequently to give the unit more fresh air.



2 YEAR PARTS AND LABOR WARRANTY (US ONLY)
5 YEAR COMPRESSOR PART WARRANTY (US ONLY)



For confirmation and updates on the latest energy star models, please visit energystar.gov



SPECIFICATIONS

Models	Door	Capacity (Cu.Ft.)	Shelves	Casters (inch)	Amps (A)	Voltage (V/Hz/Ph)	HP	Refrigerant	Exterior Dimensions (inch)	Net Weight (lbs)	Gross Weight (lbs)
MBF8505GR	1	19.1	3	4	2.1	115/60/1	1/7	R290	27×31 ^{7/10} ×83 ^{1/10}	249	282
MBF8507GR	2	43.8	6	4	3.2	115/60/1	1/5	R290	54 ^{2/5} ×31 ^{7/10} ×83 ^{1/10}	397	452
MBF8508GR	3	68	9	4	4.2	115/60/1	1/4	R290	81 ^{9/10} ×31 ^{7/10} ×83 ^{1/10}	538	615

PLAN VIEW

MBF8505GR

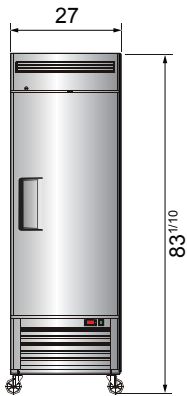

MBF8507GR



MBF8508GR

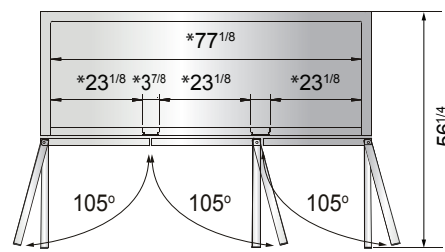
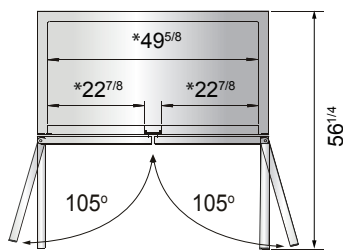
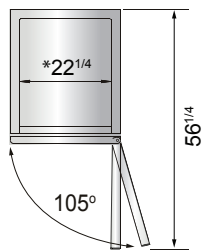
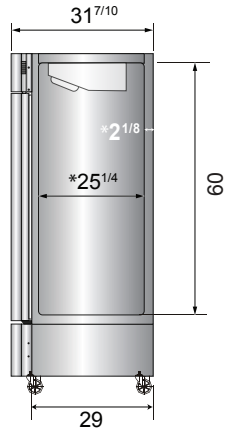
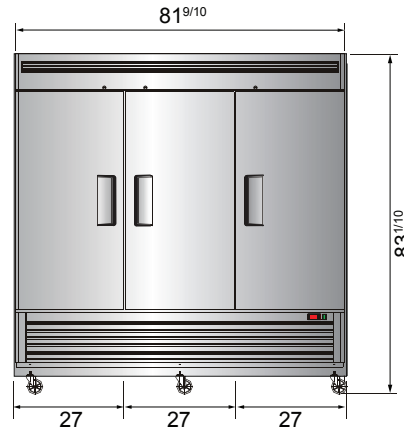

*Interior Dimensions

SELF-CLOSING AND STAY OPEN DOOR FEATURE

Casters

Epoxy shelves

Door lock

Down duct

Temperature control

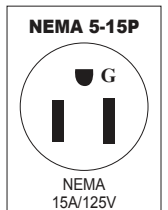



Bottom Mount Reach-In Freezers

MODELS:

MBF8501GR / MBF8503GR / MBF8504GR

Standard Features

- Bottom mount compressor units with environmentally friendly R290 refrigerant
- Stainless steel exterior & interior
- Dixell digital controller
- Maintains temperatures between -8°F – 0°F
- LED interior light(s)
- Recessed door handle(s)
- Door lock(s) standard
- Magnetic door gasket(s) standard for positive door seal
- Pre-installed casters
- Three(3) pre-installed shelves per section
- Down duct refrigeration to ensure even distribution of air



MBF8501GR



MBF8503GR



MBF8504GR

Optional Accessories

- Extra shelves – includes 4 shelf clips per shelf
MBF8501GR shelf part #: W0402393
MBF8503GR shelf part #: W0402387
MBF8504GR shelf part #: W0402387 left/right shelf, part #: W0402388 middle shelf



MBF8503GR

For the best results of food preservation we recommend setting your freezer between -8 °F to 0 °F

1. Don't forget to leave the unit some room to breathe!
2. Please clean the condenser frequently to give the unit more fresh air.



2 YEAR PARTS AND LABOR WARRANTY (US ONLY)
5 YEAR COMPRESSOR PART WARRANTY (US ONLY)



For confirmation and updates on the latest energy star models, please visit energystar.gov



SPECIFICATIONS

Models	Door	Capacity (Cu.Ft.)	Shelves	Casters (inch)	Amps (A)	Voltage (V/Hz/Ph)	HP	Refrigerant	Exterior Dimensions (inch)	Net Weight (lbs)	Gross Weight (lbs)
MBF8501GR	1	19.1	3	4	6.3	115/60/1	1/2	R290	27×31 ^{7/10} ×83 ^{1/10}	265	298
MBF8503GR	2	44.8	6	4	8.6	115/60/1	3/4	R290	54 ^{2/5} ×31 ^{7/10} ×83 ^{1/10}	410	465
MBF8504GR	3	68	9	4	6.2	208-230/115/60/1	1	R290	81 ^{9/10} ×31 ^{7/10} ×83 ^{1/10}	551	628

PLAN VIEW

MBF8501GR

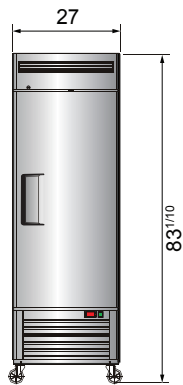

MBF8503GR



MBF8504GR

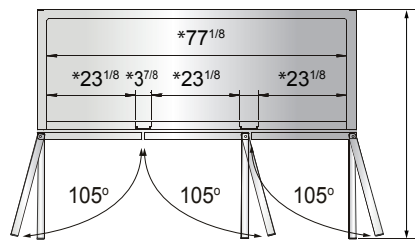
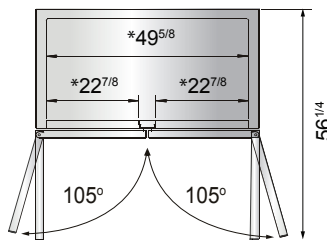
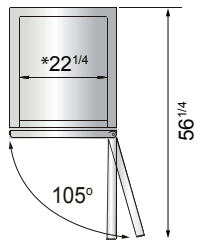
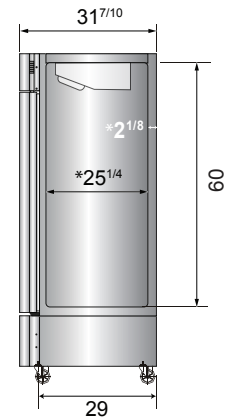
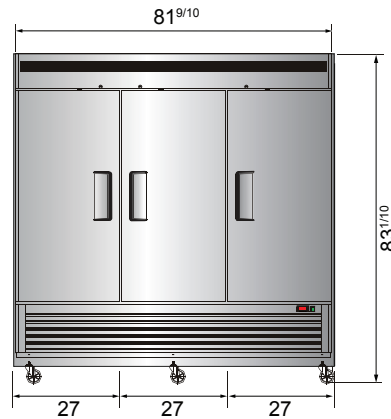

*Interior Dimensions

SELF-CLOSING AND STAY OPEN DOOR FEATURE

Casters

Epoxy shelves

Door lock

Down duct

Temperature control

MBF8504GR

MBF8501GR
MBF8503GR

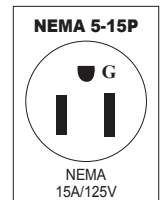
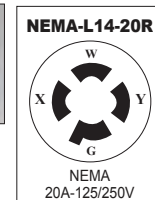

Glass Door Reach-ins



Glass Door Reach-In Refrigerators

MODELS:

MCF8705GR / MCF8707GR / MCF8709GR

Standard Features

- Stainless steel exterior & interior
- LED interior lights
- Heavy duty Embraco compressor with environmentally friendly R290 refrigerant
- Dixell digital controller
- Maintains temperatures between 33°F – 38°F
- Self-closing door(s) with automatic stay open feature
- Recessed door handle(s)
- Magnetic door gasket
- Double pane glass door
- Pre-installed casters
- NEMA-5-15P plug standard
- Four(4) pre-installed shelves per section
- Door locks standard on MCF8705GR and MCF8707GR (not available on sliding glass door model MCF8709GR)



MCF8705GR



MCF8707GR



MCF8709GR

Optional Accessories

- Extra shelves – includes 4 shelf clips per shelf



MCF8705GR

MCF8707GR

For the best results of food preservation we recommend setting your refrigerator between 33 °F to 38 °F

1. Don't forget to leave the unit some room to breathe!
2. Please clean the condenser frequently to give the unit more fresh air.



2 YEAR PARTS AND LABOR WARRANTY (US ONLY)
5 YEAR COMPRESSOR PART WARRANTY (US ONLY)



For confirmation and updates on the latest energy star models, please visit energystar.gov



SPECIFICATIONS

Models	Door	Capacity (Cu.Ft.)	Shelves	Casters (inch)	Amps (A)	Voltage (V/Hz/Ph)	HP	Refrigerant	Exterior Dimensions (inch)	Net Weight (lbs)	Gross Weight (lbs)
MCF8705GR	1	19.1	4	4	2.1	115/60/1	1/7	R290	27×31 ^{7/10} ×83 ^{1/10}	293	326
MCF8707GR	2	44.8	8	4	3.2	115/60/1	1/5	R290	54 ^{2/5} ×31 ^{7/10} ×83 ^{1/10}	485	540
MCF8709GR	2	44.9	8	2	4.2	115/60/1	1/4	R290	54 ^{2/5} ×29 ^{7/10} ×81 ^{1/5}	456	511

PLAN VIEW

MCF8705GR

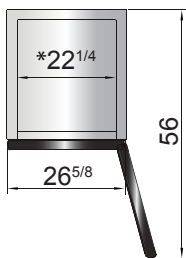
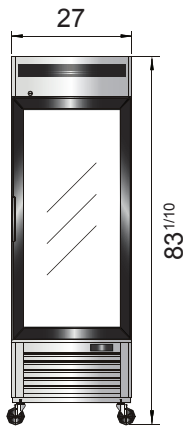

MCF8707GR

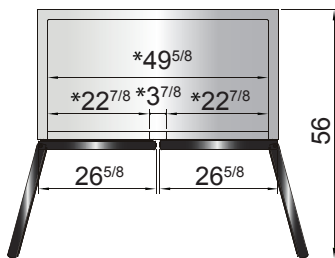

MCF8709GR

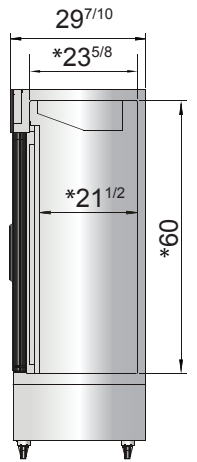
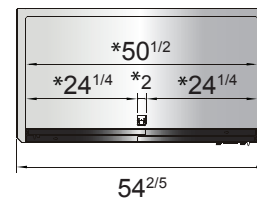
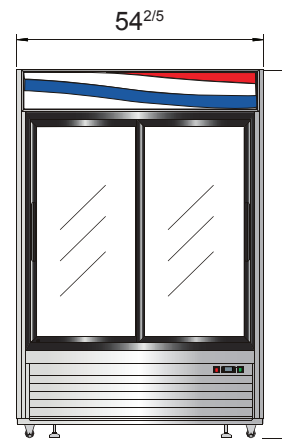
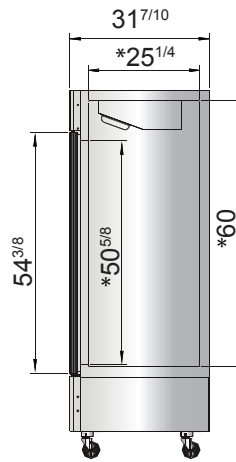

*Interior Dimensions

SELF-CLOSING AND STAY OPEN DOOR FEATURE

*Interior Dimensions

SELF-CLOSING AND STAY OPEN DOOR FEATURE

Casters



Temperature control



Door lock



LED lights



Epoxy shelves

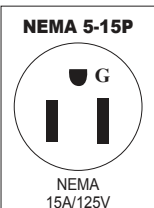



Glass Door Reach-In Freezers

Standard Features

- Stainless steel exterior & interior
- LED interior lights
- Heavy duty Embraco compressor with environmentally friendly R290 refrigerant
- Dixell digital controller
- Maintains temperatures between -8°F – 0°F
- Self-closing door(s) with automatic stay open feature
- Recessed door handle
- Magnetic door gasket
- Double pane glass door
- Pre-installed casters
- NEMA-5-15P plug standard
- Four(4) pre-installed shelves per section

Optional Accessories

- Extra shelves – includes 4 shelf clips per shelf

MODELS:

MCF8701GR / MCF8703GR



MCF8701GR



MCF8703GR



MCF8703GR

For the best results of food preservation we recommend setting your freezer between -8 °F to 0 °F

1. Don't forget to leave the unit some room to breathe!
2. Please clean the condenser frequently to give the unit more fresh air.



2 YEAR PARTS AND LABOR WARRANTY (US ONLY)
5 YEAR COMPRESSOR PART WARRANTY (US ONLY)



For confirmation and updates on the latest energy star models, please visit energystar.gov



"WE MAKE THE KITCHEN BETTER!"

Toll Free: 855-855-0399 Email: info@atosausa.com
www.atosa.com | www.atosausa.com
 California, Colorado, Florida, Georgia, Illinois,
 Massachusetts, New Jersey, Ohio, Texas, Washington

SPECIFICATIONS

Models	Door	Capacity (Cu.Ft.)	Shelves	Casters (inch)	Amps (A)	Voltage (V/Hz/Ph)	HP	Refrigerant	Exterior Dimensions (inch)	Net Weight (lbs)	Gross Weight (lbs)
MCF8701GR	1	19.1	4	4	6.3	115/60/1	1/2	R290	27×31 ^{7/10} ×83 ^{1/10}	309	342
MCF8703GR	2	44.8	8	4	8.6	115/60/1	3/4	R290	54 ^{2/5} ×31 ^{7/10} ×83 ^{1/10}	498	553

PLAN VIEW

MCF8701GR

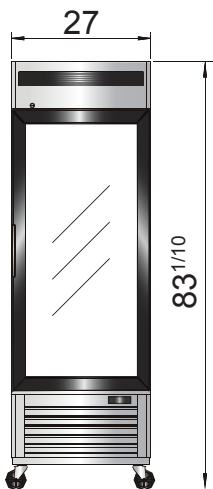

MCF8703GR

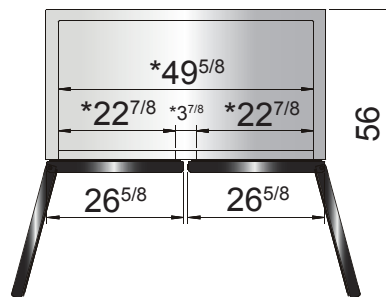
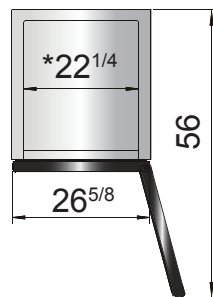
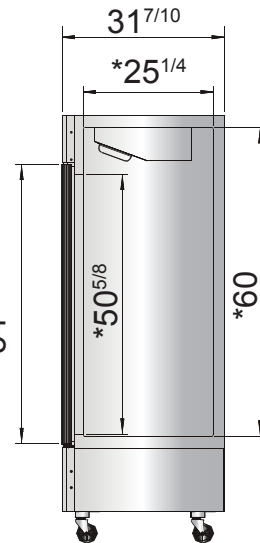

*Interior Dimensions

SELF-CLOSING
AND STAY OPEN
DOOR FEATURE

Casters

Temperature control

Door lock

LED lights

Epoxy shelves

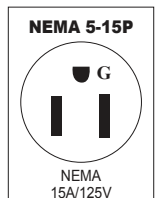



"WE MAKE THE KITCHEN BETTER!"

Toll Free: 855-855-0399 Email: info@atosausa.com
www.atosa.com | www.atosausa.com
California, Colorado, Florida, Georgia, Illinois,
Massachusetts, New Jersey, Ohio, Texas, Washington

Countertop Glassdoor Merchandisers

MODELS:

CTD-3 / CTD-3S / CTD-5

Standard Features

- Black exterior cabinet with black door frame and white interior
- Environmentally friendly R600a refrigerant
- CTD-3/CTD-5 are forced air cooling and CTD-3S is cold wall cooling
- Foamed-in-place high density polyurethane insulation
- Double pane glass door with recessed door handle
- Door lock standard
- Mechanical controller
- Pre-installed removable PVC coated wire shelves standard
- Certified for packaged foods and bottled beverages
- Maintains temperatures between 33°F- 41°F
- Magnetic door gasket standard for positive door seal
- LED interior lighting
- Leveling legs
- 5' cord with NEMA 5-15 plug standard



CTD-3



CTD-3S



CTD-5

For the best results of food preservation we recommend setting your refrigerator between 33 °F to 38 °F

1. Don't forget to leave the unit some room to breathe!
2. Please clean the condenser frequently to give the unit more fresh air.



1 YEAR PARTS AND LABOR WARRANTY (US ONLY)
5 YEAR COMPRESSOR PART WARRANTY (US ONLY)





"WE MAKE THE KITCHEN BETTER!"

Toll Free: 855-855-0399 Email: info@atosausa.com
 www.atosa.com | www.atosausa.com
 California, Colorado, Florida, Georgia, Illinois,
 Massachusetts, New Jersey, Ohio, Texas, Washington

SPECIFICATIONS

Models	Door	Capacity (Cu.Ft.)	Shelves	Amps(A)	Voltage (V/Hz/Ph)	HP	Refrigerant	Exterior Dimensions (inch)	Net Weight (lbs)	Gross Weight (lbs)
CTD-3	1	2.4	3	1.5	115/60/1	1/10	R600a	17 ^{1/4} ×19 ^{3/4} ×27 ^{1/2}	53	57
CTD-3S	1	2.4	3	1.5	115/60/1	1/8	R600a	18 ^{1/8} ×18 ^{1/2} ×33	64	70
CTD-5	1	4.6	4	1.7	115/60/1	1/8	R600a	21 ^{1/4} ×22×33 ^{3/4}	88	95

PLAN VIEW

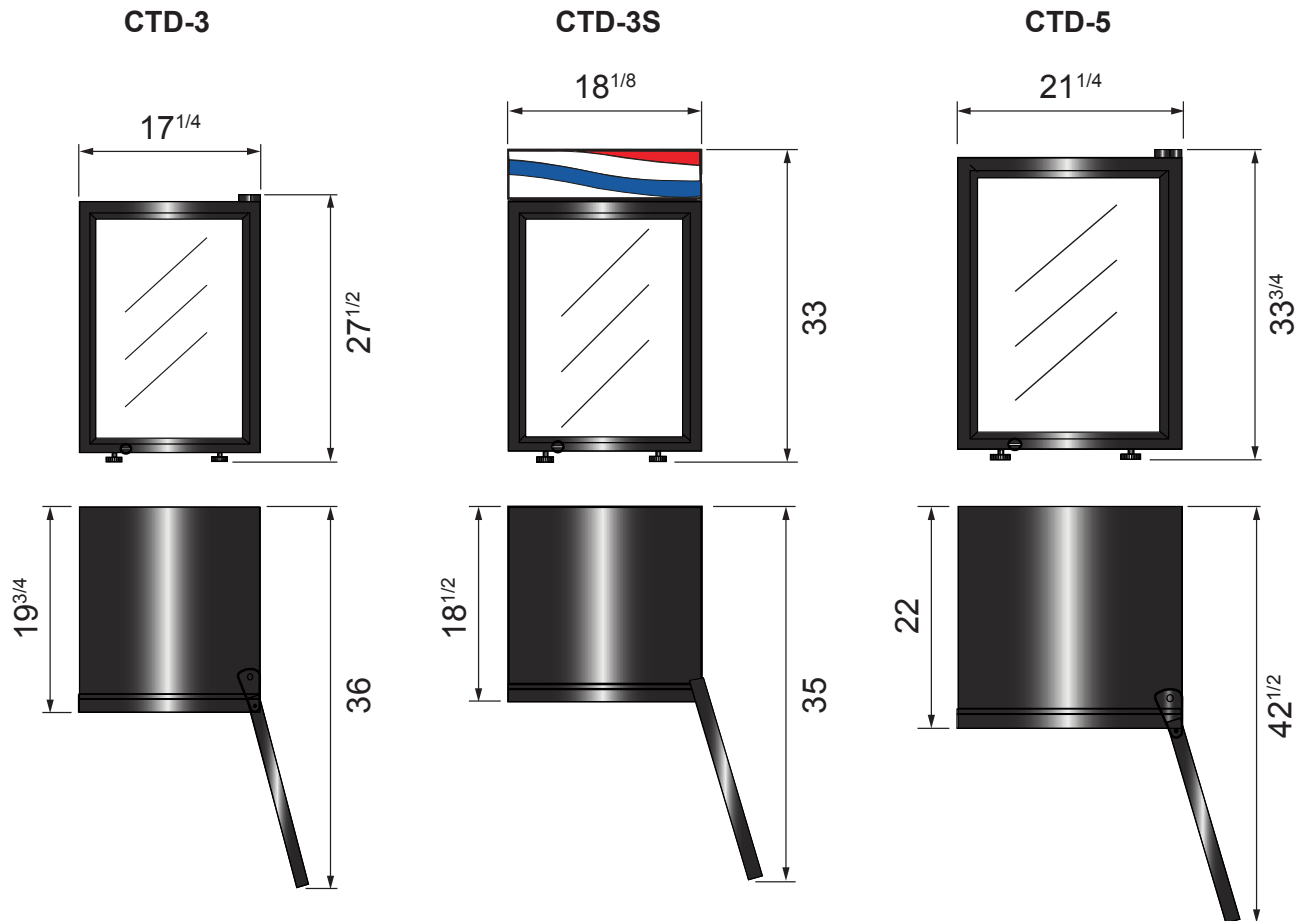

Door lock

LED lights

Epoxy shelves

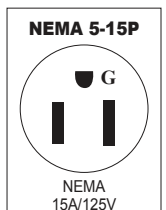



“WE MAKE THE KITCHEN BETTER!”

Toll Free: 855-855-0399 Email: info@atosausa.com
www.atosa.com | www.atosausa.com
California, Colorado, Florida, Georgia, Illinois,
Massachusetts, New Jersey, Ohio, Texas, Washington

Countertop Refrigerated Display Cases

- Curved / Square

MODELS:

CRDC-35 / CRDC-46 / CRDS-42 / CRDS-56

Standard Features

- Stainless steel exterior & interior with black frames
- Rear mount compressor with environmentally friendly R290 refrigerant
- Dixell digital controller
- Two(2) stainless steel shelves standard
- Defog feature to ensure the glass stays clear
- Maintains temperatures between 33°F – 41°F
- Magnetic door gasket(s) standard for positive door seal
- Two(2) rear sliding doors
- LED interior lighting
- Leveling legs
- NEMA 5-15 plug



CRDC-35



CRDC-46



CRDS-56



CRDS-42

For the best results of food preservation we recommend setting your refrigerator between 33 °F to 38°F

1. Don't forget to leave the unit some room to breathe!
2. Please clean the condenser frequently to give the unit more fresh air.



1 YEAR PARTS AND LABOR WARRANTY (US ONLY)
5 YEAR COMPRESSOR PART WARRANTY (US ONLY)





"WE MAKE THE KITCHEN BETTER!"

Toll Free: 855-855-0399 Email: info@atosausa.com
 www.atosa.com | www.atosausa.com
 California, Colorado, Florida, Georgia, Illinois,
 Massachusetts, New Jersey, Ohio, Texas, Washington

SPECIFICATIONS

Models	Door	Capacity (Cu.Ft.)	Shelves	Amps(A)	Voltage (V/Hz/Ph)	HP	Refrigerant	Exterior Dimensions (inch)	Net Weight (lbs)	Gross Weight (lbs)
CRDC-35	2	3.5	2	2	115/60/1	1/5	R290	27 ^{3/5} ×22 ^{1/10} ×26 ^{2/5}	139	172
CRDC-46	2	4.6	2	2	115/60/1	1/5	R290	35 ^{2/5} ×22 ^{1/10} ×26 ^{2/5}	154	200
CRDS-42	2	4.2	2	2	115/60/1	1/5	R290	27 ^{3/5} ×22 ^{1/10} ×26 ^{2/5}	143	192
CRDS-56	2	5.6	2	2	115/60/1	1/5	R290	35 ^{2/5} ×22 ^{1/10} ×26 ^{2/5}	165	214

PLAN VIEW



LED lights

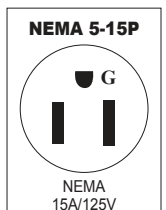



“WE MAKE THE KITCHEN BETTER!”

Toll Free: 855-855-0399 Email: info@atosausa.com
www.atosa.com | www.atosausa.com
California, Colorado, Florida, Georgia, Illinois,
Massachusetts, New Jersey, Ohio, Texas, Washington

Black Exterior Glass Door Refrigerator Merchandiser

MODELS:

MCF8725GR

Standard Features

- Black steel exterior with stainless steel interior
- Lighted header panel
- LED interior lighting standard
- Dixell electronic controller
- Four(4) shelves standard per section
- Double pane glass door
- Self-closing door(s) with automatic stay open feature
- Recessed door handle
- Door lock(s) standard
- Magnetic door gasket
- Self-contained bottom mount refrigeration system with environmentally friendly R290 refrigerant
- Pre-installed casters
- Pre-installed shelves
- NEMA-5-15P plug standard



Optional Accessories

- Extra shelves – includes 4 shelf clips per shelf

For the best results of food preservation we recommend setting your refrigerator between 33 °F - 38 °F

1. Don't forget to leave the unit some room to breathe!
2. Please clean the condenser frequently to give the unit more fresh air.



2 YEAR PARTS AND LABOR WARRANTY (US ONLY)
5 YEAR COMPRESSOR PART WARRANTY (US ONLY)





"WE MAKE THE KITCHEN BETTER!"

Toll Free: 855-855-0399 Email: info@atosausa.com
 www.atosa.com | www.atosausa.com
 California, Colorado, Florida, Georgia, Illinois,
 Massachusetts, New Jersey, Ohio, Texas, Washington

SPECIFICATIONS

Models	Door	Capacity (Cu.Ft.)	Shelves	Casters (inch)	Amps (A)	Voltage (V/Hz/Ph)	HP	Refrigerant	Exterior Dimensions (inch)	Net Weight (lbs)	Gross Weight (lbs)
MCF8725GR	1	11.1	4	2	2.1	115/60/1	1/7	R290	24 ^{1/5} ×24×76 ^{1/5}	227	251

PLAN VIEW

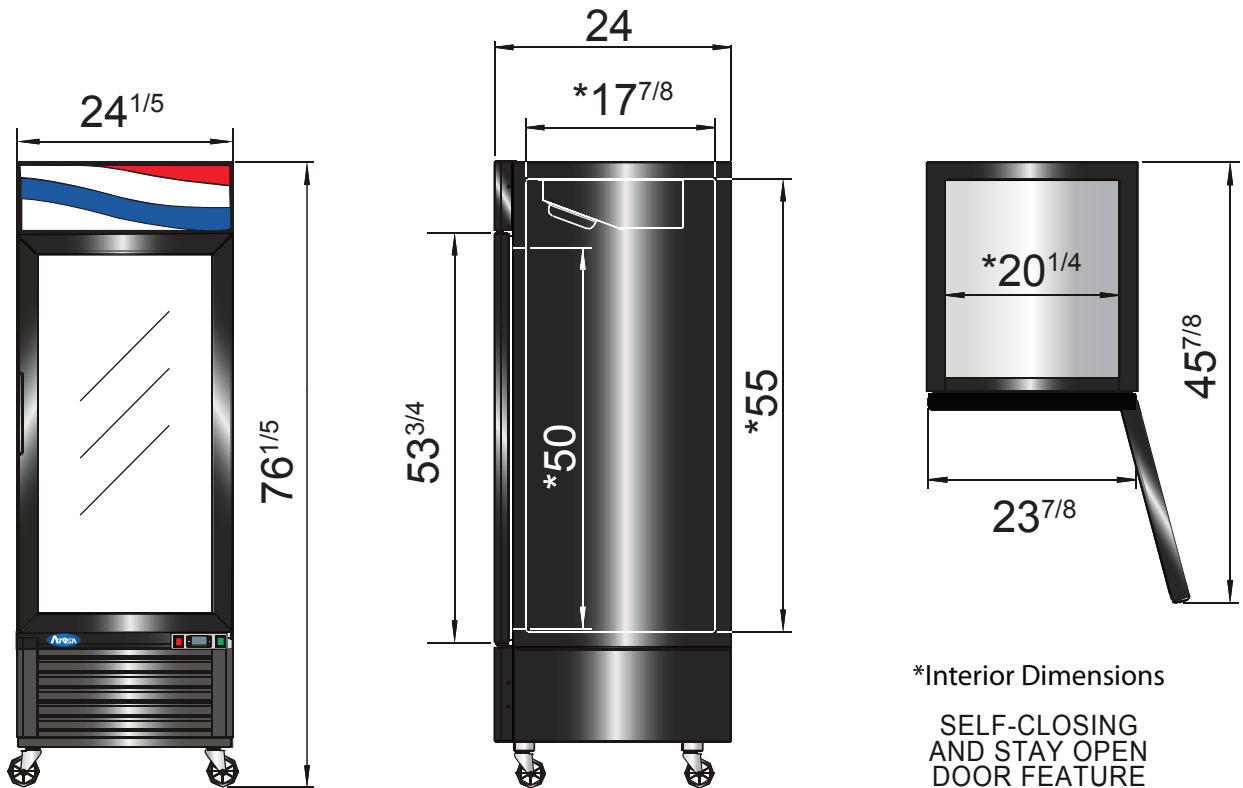

Casters



Temperature control



Door lock



LED lights



Epoxy shelves

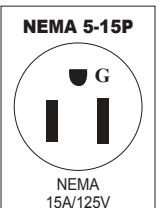



“WE MAKE THE KITCHEN BETTER!”

Toll Free: 855-855-0399 Email: info@atosausa.com
www.atosa.com | www.atosausa.com
California, Colorado, Florida, Georgia, Illinois,
Massachusetts, New Jersey, Ohio, Texas, Washington

Black Exterior Glass Door Refrigerator Merchandisers

Standard Features

- Black steel exterior with stainless steel interior
- Lighted header panel
- LED interior lighting standard
- Dixell electronic controller
- Four(4) shelves standard per section
- Double pane glass door(s)
- Self-closing door(s) with automatic stay open feature
- Recessed door handle
- Door lock(s) standard
- Magnetic door gasket
- Self-contained bottom mount refrigeration system with environmentally friendly R290 refrigerant
- Pre-installed casters
- Pre-installed shelves
- NEMA-5-15P plug standard

Optional Accessories

- Extra shelves – includes 4 shelf clips per shelf



MCF8722GR
MCF8723GR

For the best results of food preservation we recommend setting your refrigerator between 33 °F to 38 °F

1. Don't forget to leave the unit some room to breathe!
2. Please clean the condenser frequently to give the unit more fresh air.



2 YEAR PARTS AND LABOR WARRANTY (US ONLY)
5 YEAR COMPRESSOR PART WARRANTY (US ONLY)

MODELS:

MCF8722GR / MCF8723GR / MCF8724GR



MCF8722GR



MCF8723GR



MCF8724GR



For confirmation and updates on the latest energy star models, please visit energystar.gov



“WE MAKE THE KITCHEN BETTER!”

Toll Free: 855-855-0399 Email: info@atosausa.com
www.atosa.com | www.atosausa.com
 California, Colorado, Florida, Georgia, Illinois,
 Massachusetts, New Jersey, Ohio, Texas, Washington

SPECIFICATIONS

Models	Door	Capacity (Cu.Ft.)	Shelves	Casters (inch)	Amps (A)	Voltage (V/Hz/Ph)	HP	Refrigerant	Exterior Dimensions (inch)	Net Weight (lbs)	Gross Weight (lbs)
MCF8722GR	1	19.4	4	2	2.1	115/60/1	1/7	R290	27×31 ^{1/2} ×81 ^{1/5}	293	326
MCF8723GR	2	43.8	8	2	3.2	115/60/1	1/5	R290	54 ^{2/5} ×31 ^{1/2} ×81 ^{1/5}	485	540
MCF8724GR	3	69.5	12	2	4.2	115/60/1	1/4	R290	81 ^{9/10} ×31 ^{1/2} ×81 ^{1/5}	653	761

PLAN VIEW

MCF8722GR

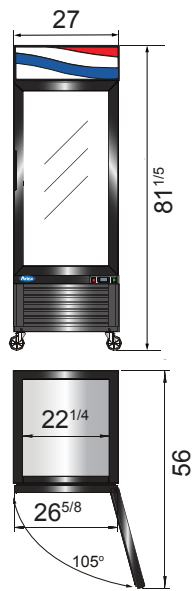

MCF8723GR

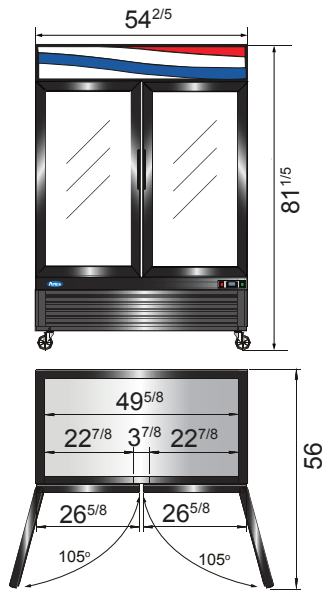

MCF8724GR

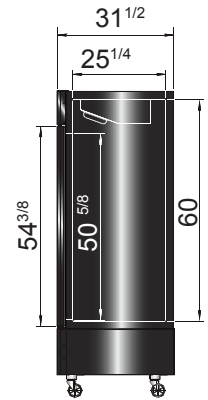
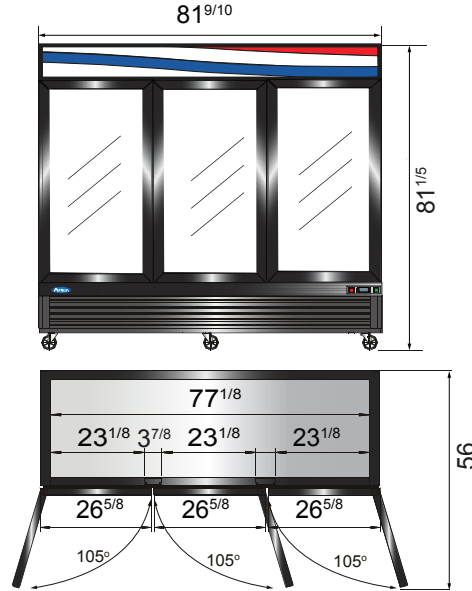

*Interior Dimensions

SELF-CLOSING AND STAY OPEN DOOR FEATURE

Casters



Temperature control



Door lock



LED lights



Epoxy shelves



NEMA 5-15P

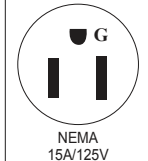

NEMA 15A/125V



"WE MAKE THE KITCHEN BETTER!"

Toll Free: 855-855-0399 Email: info@atosausa.com
www.atosa.com | www.atosausa.com
California, Colorado, Florida, Georgia, Illinois,
Massachusetts, New Jersey, Ohio, Texas, Washington

Back Bar Coolers

MODELS:

MBB48GR / MBB59GR / MBB69GR / MBB90GR

Standard Features

- Stainless steel exterior & interior
- Dixell digital controller
- Maintains temperatures between 33°F– 40°F
- Heavy duty Embraco compressor with environmentally friendly R290 refrigerant
- Slide out compressor assembly for easy maintenance
- Recessed door handle(s)
- Interior light(s)
- Magnetic door gasket(s) standard for positive door seal
- Door lock(s) standard
- Pre-installed epoxy coated shelves
- Pre-installed casters



MBB48GR



MBB59GR



MBB90GR



MBB69GR

For the best results of food preservation we recommend setting your refrigerator between 33 °F - 38 °F

1. Don't forget to leave the unit some room to breathe!
2. Please clean the condenser frequently to give the unit more fresh air.



2 YEAR PARTS AND LABOR WARRANTY (US ONLY)
5 YEAR COMPRESSOR PART WARRANTY (US ONLY)





"WE MAKE THE KITCHEN BETTER!"

Toll Free: 855-855-0399 Email: info@atosausa.com

www.atosa.com | www.atosausa.com

California, Colorado, Florida, Georgia, Illinois, Massachusetts, New Jersey, Ohio, Texas, Washington

SPECIFICATIONS

Models	Door	Capacity (Cu.Ft.)	Shelves	Casters (inch)	Amps (A)	Voltage (V/Hz/Ph)	HP	Refrigerant	Exterior Dimensions (inch)	Net Weight (lbs)	Gross Weight (lbs)
MBB48GR	2	12.9	4	2	2.3	115/60/1	1/7	R290	48×28 ^{1/10} ×40 ^{1/10}	192	240
MBB59GR	2	17.3	4	2	2.3	115/60/1	1/7	R290	57 ^{4/5} ×28 ^{1/10} ×40 ^{1/10}	214	262
MBB69GR	2	21.5	4	2	2.3	115/60/1	1/7	R290	68×28 ^{1/10} ×40 ^{1/10}	238	295
MBB90GR	3	30.1	6	2	2.8	115/60/1	1/5	R290	89 ^{3/10} ×28 ^{1/10} ×40 ^{1/10}	295	370

PLAN VIEW

MBB48GR

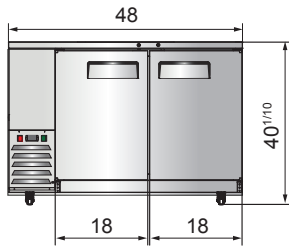

MBB59GR

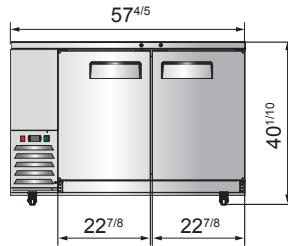

MBB69GR

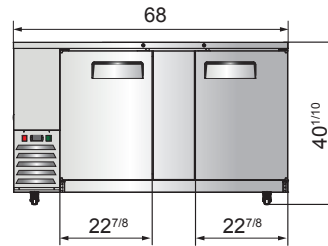

MBB90GR

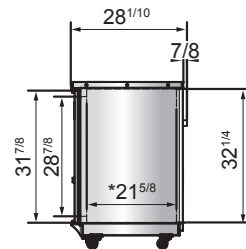
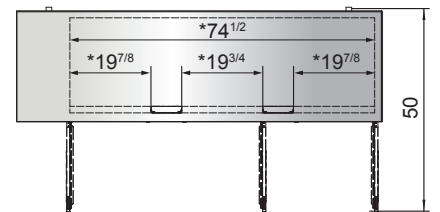
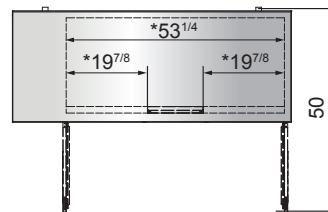
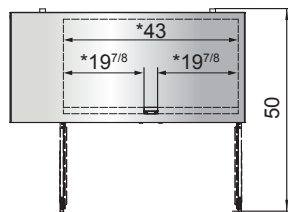
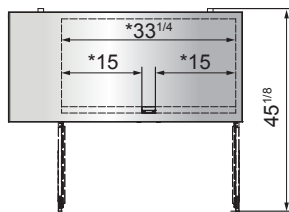
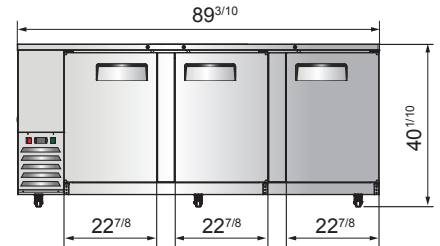

*Interior Dimensions

Epoxy shelves



Door lock



Temperature control



Recessed handles

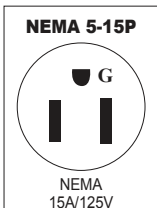



"WE MAKE THE KITCHEN BETTER!"

Toll Free: 855-855-0399 Email: info@atosausa.com
www.atosa.com | www.atosausa.com
California, Colorado, Florida, Georgia, Illinois,
Massachusetts, New Jersey, Ohio, Texas, Washington

Back Bar Coolers With Glass Doors

Standard Features

- Stainless steel exterior & interior
- Dixell digital controller
- Maintains temperatures between 33°F – 40°F
- Heavy duty Embraco compressor with environmentally friendly R290 refrigerant
- Slide out compressor assembly for easy maintenance
- LED Interior light(s)
- Magnetic door gasket(s) standard for positive door seal
- Door lock(s) standard
- Pre-installed epoxy coated shelves
- Pre-installed casters

MODELS:

MBB48G-GR / MBB59G-GR
MBB69G-GR / MBB90G-GR



MBB48G-GR



MBB59G-GR



MBB90G-GR



MBB69G-GR

For the best results of food preservation we recommend setting your refrigerator between 33 °F - 38 °F

1. Don't forget to leave the unit some room to breathe!
2. Please clean the condenser frequently to give the unit more fresh air.



2 YEAR PARTS AND LABOR WARRANTY (US ONLY)
5 YEAR COMPRESSOR PART WARRANTY (US ONLY)





"WE MAKE THE KITCHEN BETTER!"

Toll Free: 855-855-0399 Email: info@atosausa.com
 www.atosa.com | www.atosausa.com
 California, Colorado, Florida, Georgia, Illinois,
 Massachusetts, New Jersey, Ohio, Texas, Washington

SPECIFICATIONS

Models	Door	Capacity (Cu.Ft.)	Shelves	Casters (inch)	Amps (A)	Voltage (V/Hz/Ph)	HP	Refrigerant	Exterior Dimensions (inch)	Net Weight (lbs)	Gross Weight (lbs)
MBB48G-GR	2	12.9	4	2	2.3	115/60/1	1/7	R290	48×28 ^{1/10} ×40 ^{1/10}	214	262
MBB59G-GR	2	17.3	4	2	2.3	115/60/1	1/7	R290	57 ^{4/5} ×28 ^{1/10} ×40 ^{1/10}	236	284
MBB69G-GR	2	21.5	4	2	2.3	115/60/1	1/7	R290	68×28 ^{1/10} ×40 ^{1/10}	260	317
MBB90G-GR	3	30.1	6	2	2.8	115/60/1	1/5	R290	89 ^{3/10} ×28 ^{1/10} ×40 ^{1/10}	317	392

PLAN VIEW

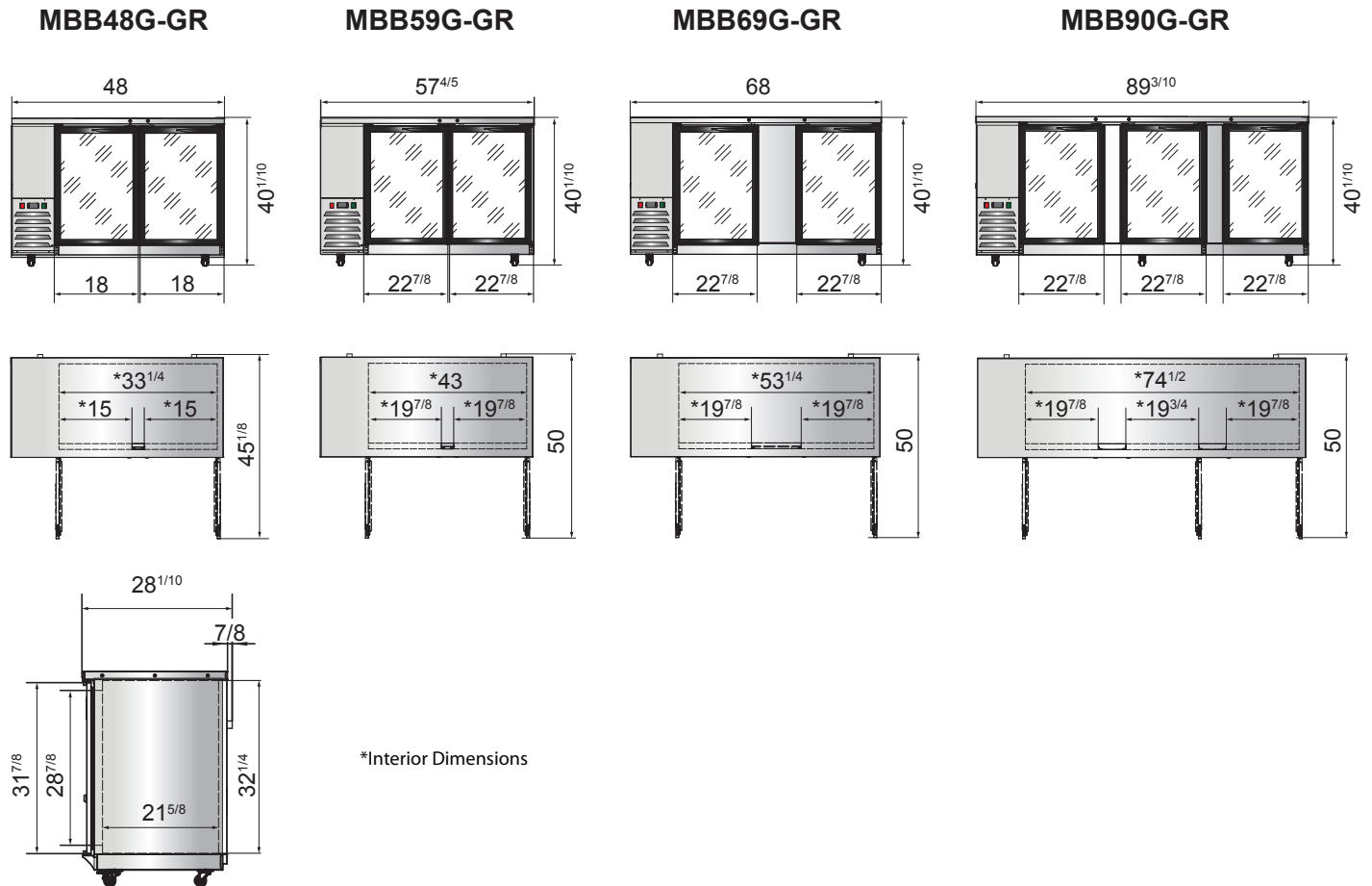

Epoxy shelves



Door lock



Temperature control

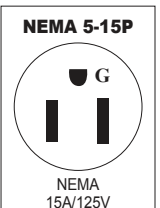



"WE MAKE THE KITCHEN BETTER!"

Toll Free: 855-855-0399 Email: info@atosausa.com
www.atosa.com | www.atosausa.com
California, Colorado, Florida, Georgia, Illinois,
Massachusetts, New Jersey, Ohio, Texas, Washington

Horizontal Bottle Coolers

Standard Features

- Stainless steel exterior & interior
- Dixell digital controller
- Maintains temperatures between 33°F – 40°F
- Heavy duty Embraco compressor with environmentally friendly R290 refrigerant
- Slide out compressor assembly for easy maintenance
- Easy glide stainless steel lid(s) with handle(s)
- Lid lock(s) standard
- Bottle opener & cap catcher standard
- Wire dividers standard
- Pre-installed casters

MODELS:

MBC50GR / MBC65GR / MBC80GR



MBC50GR



MBC65GR



MBC80GR

For the best results of food preservation we recommend setting your refrigerator between 33 °F to 38 °F

1. Don't forget to leave the unit some room to breathe!
2. Please clean the condenser frequently to give the unit more fresh air.



2 YEAR PARTS AND LABOR WARRANTY (US ONLY)
5 YEAR COMPRESSOR PART WARRANTY (US ONLY)





"WE MAKE THE KITCHEN BETTER!"

Toll Free: 855-855-0399 Email: info@atosausa.com
 www.atosa.com | www.atosausa.com
 California, Colorado, Florida, Georgia, Illinois,
 Massachusetts, New Jersey, Ohio, Texas, Washington

SPECIFICATIONS

Models	Capacity (Cu.Ft.)	Wire dividers	Casters (inch)	Amps (A)	Voltage (V/Hz/Ph)	HP	Refrigerant	Exterior Dimensions (inch)	Net Weight (lbs)	Gross Weight (lbs)
MBC50GR	11.7	3	2	2.3	115/60/1	1/7	R290	49 ^{2/5} ×27 ^{4/5} ×36 ^{3/5}	176	236
MBC65GR	16.4	4	2	2.3	115/60/1	1/7	R290	64 ^{4/5} ×27 ^{4/5} ×36 ^{3/5}	205	278
MBC80GR	21.2	5	2	2.8	115/60/1	1/5	R290	80 ^{1/2} ×27 ^{4/5} ×36 ^{3/5}	251	344

PLAN VIEW

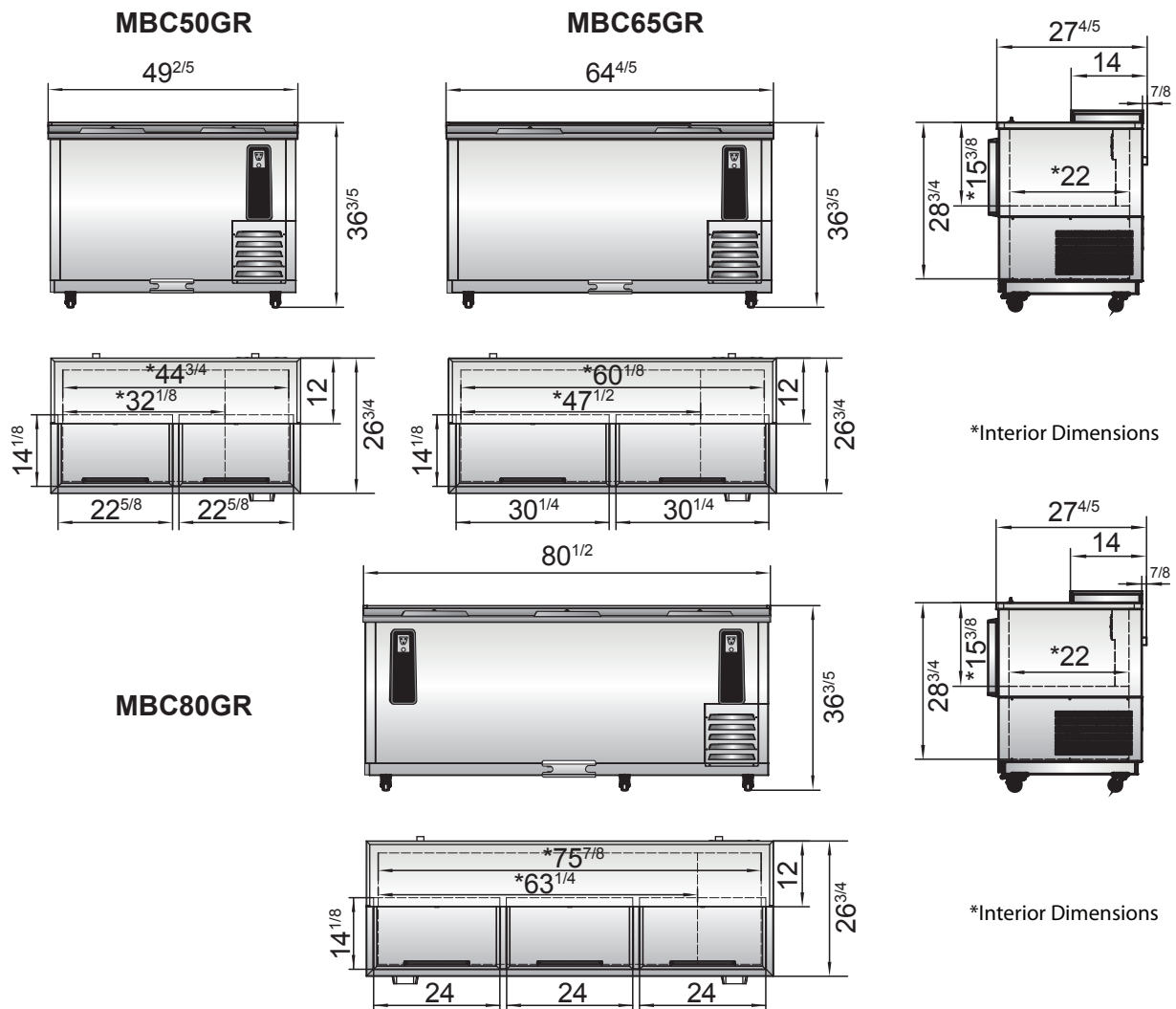

Stainless steel lids

Bottle opener and cap catcher

Wire dividers

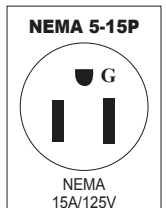



"WE MAKE THE KITCHEN BETTER!"

Toll Free: 855-855-0399 Email: info@atosausa.com
www.atosa.com | www.atosausa.com
California, Colorado, Florida, Georgia, Illinois,
Massachusetts, New Jersey, Ohio, Texas, Washington

Direct Draw Keg Coolers

MODELS:

MKC23GR / MKC58GR / MKC68GR / MKC90GR

Standard Features

- Stainless steel exterior & interior
- Dixell digital controller
- Maintains temperatures between 33°F – 40°F
- Heavy duty Embraco compressor with environmentally friendly R290 refrigerant
- Slide out compressor assembly for easy maintenance
- Stainless steel drip tray(s)
- Recessed door handle(s)
- Dual tap tower(s) standard
- Interior light(s)
- Magnetic door gasket(s) standard for positive door seal
- Manifold and ball taps included
- Door lock(s) standard
- Pre-installed casters



MKC23GR



MKC58GR



MKC68GR



MKC90GR

Model#	Sixth Barrel	Quarter Barrel	Slim Quarter	Half Barrel
MKC23GR				1
MKC23GR	2			
MKC23GR		1		
MKC58GR	1			2
MKC58GR	4			
MKC58GR	1	2		
MKC58GR	1		3	
MKC68GR				3
MKC68GR	6			
MKC68GR		3		
MKC68GR	1		4	
MKC90GR	1			4
MKC90GR	8			
MKC90GR	1	4		
MKC90GR			6	

For the best results of food preservation we recommend setting your refrigerator between 33 °F to 38 °F

1. Don't forget to leave the unit some room to breathe!
2. Please clean the condenser frequently to give the unit more fresh air.



2 YEAR PARTS AND LABOR WARRANTY (US ONLY)
5 YEAR COMPRESSOR PART WARRANTY (US ONLY)





“WE MAKE THE KITCHEN BETTER!”

Toll Free: 855-855-0399 Email: info@atosausa.com
www.atosa.com | www.atosausa.com
 California, Colorado, Florida, Georgia, Illinois,
 Massachusetts, New Jersey, Ohio, Texas, Washington

SPECIFICATIONS

Models	Door	Capacity (Cu.Ft.)	Casters (inch)	Amps (A)	Voltage (V/Hz/Ph)	HP	Refrigerant	Exterior Dimensions (inch)	Net Weight (lbs)	Gross Weight (lbs)
MKC23GR	1	7.1	2	2.3	115/60/1	1/7	R290	23×31 ^{1/10} ×39 ^{3/10}	132	188
MKC58GR	2	17.3	2	2.3	115/60/1	1/7	R290	57 ^{4/5} ×28 ^{1/10} ×40 ^{1/10}	209	243
MKC68GR	2	21.5	2	2.3	115/60/1	1/7	R290	68×28 ^{1/10} ×40 ^{1/10}	234	291
MKC90GR	3	30.1	2	2.8	115/60/1	1/5	R290	89 ^{3/10} ×28 ^{1/10} ×40 ^{1/10}	282	357

PLAN VIEW

MKC23GR

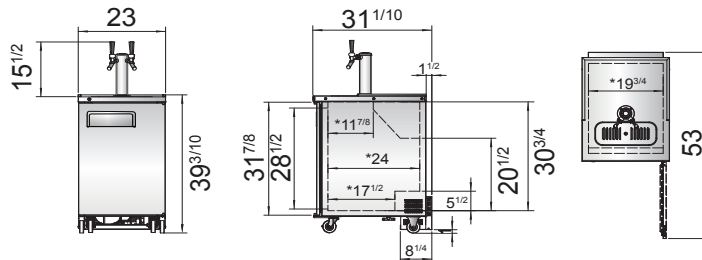

MKC58GR

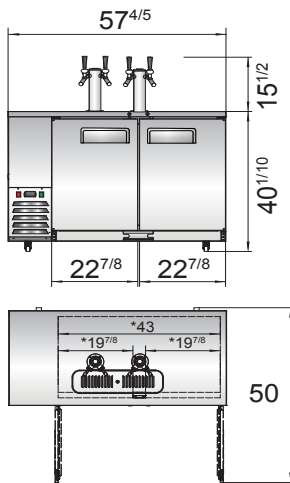

MKC68GR

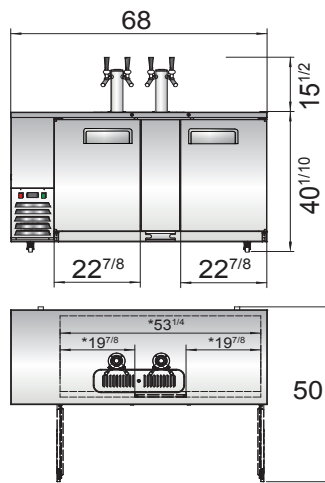

MKC90GR

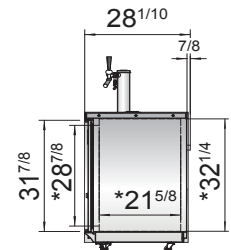
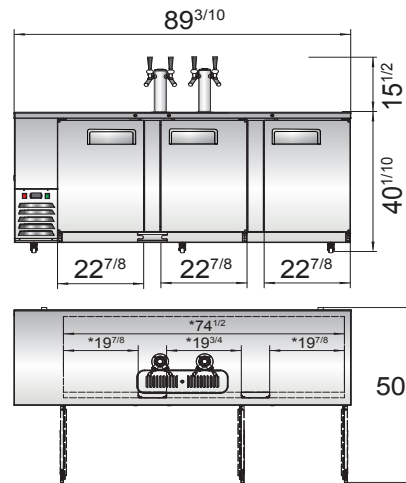

Dual tap towers

Stainless steel drip tray

Manifold and ball taps

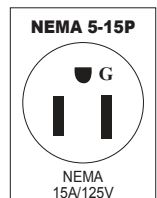
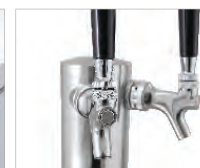



“WE MAKE THE KITCHEN BETTER!”

Toll Free: 855-855-0399 Email: info@atosausa.com
www.atosa.com | www.atosausa.com
California, Colorado, Florida, Georgia, Illinois,
Massachusetts, New Jersey, Ohio, Texas, Washington

MODELS:

**MSF8301GR / MSF8302GR
MSF8303GR / MSF8304GR**

Standard Top Sandwich Prep Tables

Standard Features

- Stainless steel exterior & interior
- Rear mount compressor with environmentally friendly R290 refrigerant
- Dixell digital controller
- Maintains temperatures between 33°F - 40°F
- Pre-installed 4” deep stainless steel pans
- 10” cutting board
- Recessed door handle(s)
- Self-closing door(s) with stay open feature
- Magnetic door gasket(s) standard for positive door seal
- One(1) pre-installed shelf per section
- Pre-installed casters

Optional Accessories

- Double overshelf for 48”, 60” and 72” models



For the best results of food preservation we recommend setting your refrigerator between 33 °F to 38 °F

1. Don't forget to leave the unit some room to breathe!
2. Please clean the condenser frequently to give the unit more fresh air.



MSF8301GR



MSF8302GR



MSF8303GR



MSF8304GR



2 YEAR PARTS AND LABOR WARRANTY (US ONLY)
5 YEAR COMPRESSOR PART WARRANTY (US ONLY)





"WE MAKE THE KITCHEN BETTER!"

Toll Free: 855-855-0399 Email: info@atosausa.com
 www.atosa.com | www.atosausa.com
 California, Colorado, Florida, Georgia, Illinois,
 Massachusetts, New Jersey, Ohio, Texas, Washington

SPECIFICATIONS

Models	Door	Capacity (Cu.Ft.)	Shelves	Casters (inch)	Amps (A)	Voltage (V/Hz/Ph)	HP	Refrigerant	Exterior Dimensions (inch)	Net Weight (lbs)	Gross Weight (lbs)
MSF8301GR	1	7.2	1	5	2.3	115/60/1	1/7	R290	27 ^{1/2} ×30×44 ^{3/10}	159	196
MSF8302GR	2	13.4	2	5	2.3	115/60/1	1/7	R290	48 ^{1/5} ×30×44 ^{3/10}	231	276
MSF8303GR	2	17.2	2	5	2.8	115/60/1	1/5	R290	60 ^{1/5} ×30×44 ^{3/10}	271	320
MSF8304GR	3	21.1	3	5	2.8	115/60/1	1/5	R290	72 ^{7/10} ×30×44 ^{3/10}	317	379

PLAN VIEW

MSF8301GR

MSF8302GR

MSF8303GR

MSF8304GR

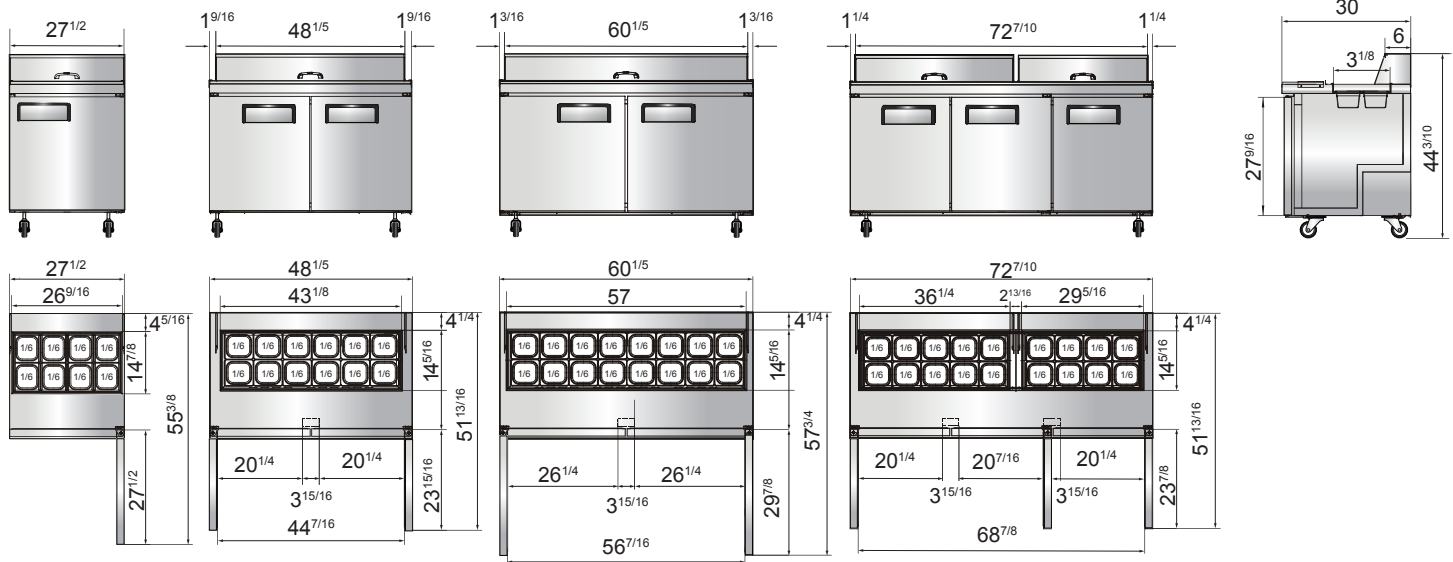

Casters



Epoxy shelves



Stainless steel pans



Rear grill



Temperature control



NEMA 5-15P



NEMA
15A/125V



“WE MAKE THE KITCHEN BETTER!”

Toll Free: 855-855-0399 Email: info@atosausa.com
www.atosa.com | www.atosausa.com
California, Colorado, Florida, Georgia, Illinois,
Massachusetts, New Jersey, Ohio, Texas, Washington

MODELS:

MSF8305GR / MSF8306GR / MSF8307GR / MSF8308GR

Mega Top Sandwich Prep Tables

Standard Features

- Stainless steel exterior & interior
- Rear mount compressor with environmentally friendly R290 refrigerant
- Dixell digital controller
- Maintains temperatures between 33°F - 40°F
- Pre-installed 4" deep stainless steel pans
- 10" cutting board
- Recessed door handle(s)
- Self-closing door(s) with stay open feature
- Magnetic door gasket(s) standard for positive door seal
- One(1) pre-installed shelf per section
- Pre-installed casters

Optional Accessories

- Double overshelf for 48", 60" and 72" models



For the best results of food preservation we recommend setting your refrigerator between 33 °F to 38 °F

1. Don't forget to leave the unit some room to breathe!
2. Please clean the condenser frequently to give the unit more fresh air.



MSF8305GR



MSF8306GR



MSF8307GR



MSF8308GR



2 YEAR PARTS AND LABOR WARRANTY (US ONLY)
5 YEAR COMPRESSOR PART WARRANTY (US ONLY)





“WE MAKE THE KITCHEN BETTER!”

Toll Free: 855-855-0399 Email: info@atosausa.com
www.atosa.com | www.atosausa.com
 California, Colorado, Florida, Georgia, Illinois,
 Massachusetts, New Jersey, Ohio, Texas, Washington

SPECIFICATIONS

Models	Door	Capacity (Cu.Ft.)	Shelves	Casters (inch)	Amps (A)	Voltage (V/Hz/Ph)	HP	Refrigerant	Exterior Dimensions (inch)	Net Weight (lbs)	Gross Weight (lbs)
MSF8305GR	1	7.2	1	5	2.3	115/60/1	1/7	R290	27 ^{1/2} ×34×46 ^{3/5}	170	212
MSF8306GR	2	13.4	2	5	2.3	115/60/1	1/7	R290	48 ^{1/5} ×34×46 ^{3/5}	243	293
MSF8307GR	2	17.2	2	5	2.8	115/60/1	1/5	R290	60 ^{1/5} ×34×46 ^{3/5}	284	340
MSF8308GR	3	21.1	3	5	2.8	115/60/1	1/5	R290	72 ^{7/10} ×34×46 ^{3/5}	331	401

PLAN VIEW

MSF8305GR

MSF8306GR

MSF8307GR

MSF8308GR

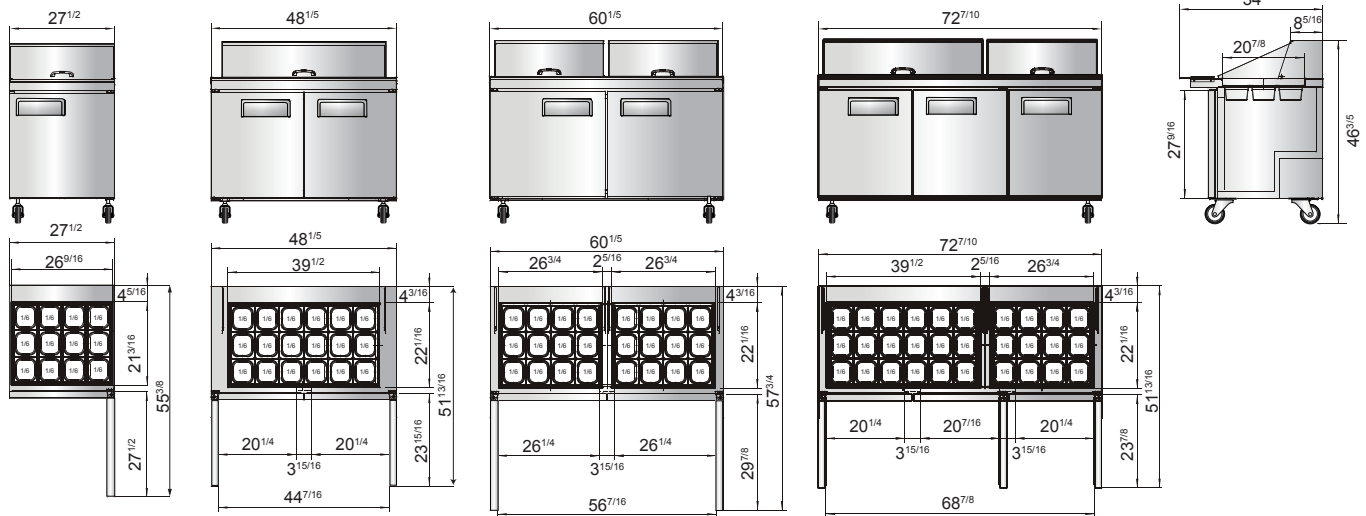

Casters



Epoxy shelves



Stainless steel pans



Rear grill



Temperature control



NEMA 5-15P

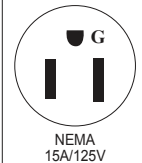

NEMA 15A/125V



“WE MAKE THE KITCHEN BETTER!”

Toll Free: 855-855-0399 Email: info@atosausa.com
www.atosa.com | www.atosausa.com
California, Colorado, Florida, Georgia, Illinois,
Massachusetts, New Jersey, Ohio, Texas, Washington

Refrigerated Pizza Prep Tables

Standard Features

- Side mount compressor with environmentally friendly R290 refrigerant
- Stainless steel exterior & interior
- Dixell digital controller
- Maintains temperatures between 34°F – 40°F
- Stainless steel 1/3 size pans included
- 19” cutting board standard
- Self-closing door(s) with stay open feature
- Recessed door handle(s)
- Magnetic door gasket(s) standard for positive door seal
- Two(2) pre-installed shelves per section
- Pre-installed casters

MODELS:

MPF8201GR / MPF8202GR / MPF8203GR



MPF8201GR



MPF8202GR



MPF8203GR

For the best results of food preservation we recommend setting your refrigerator between 33 °F to 38 °F

1. Don't forget to leave the unit some room to breathe!
2. Please clean the condenser frequently to give the unit more fresh air.



2 YEAR PARTS AND LABOR WARRANTY (US ONLY)
5 YEAR COMPRESSOR PART WARRANTY (US ONLY)





“WE MAKE THE KITCHEN BETTER!”

Toll Free: 855-855-0399 Email: info@atosausa.com

www.atosa.com | www.atosausa.com

California, Colorado, Florida, Georgia, Illinois, Massachusetts, New Jersey, Ohio, Texas, Washington

SPECIFICATIONS

Models	Door	Capacity (Cu.Ft.)	Shelves	Casters (inch)	Amps (A)	Voltage (V/Hz/Ph)	HP	Refrigerant	Exterior Dimensions (inch)	Net Weight (lbs)	Gross Weight (lbs)
MPF8201GR	1	9.7	2	5	2.3	115/60/1	1/7	R290	44×33 ^{1/10} ×44	238	295
MPF8202GR	2	18.5	4	5	2.8	115/60/1	1/5	R290	67×33 ^{1/10} ×44	335	406
MPF8203GR	3	28.4	6	5	3.1	115/60/1	1/4	R290	93×33 ^{1/10} ×44	428	527

PLAN VIEW

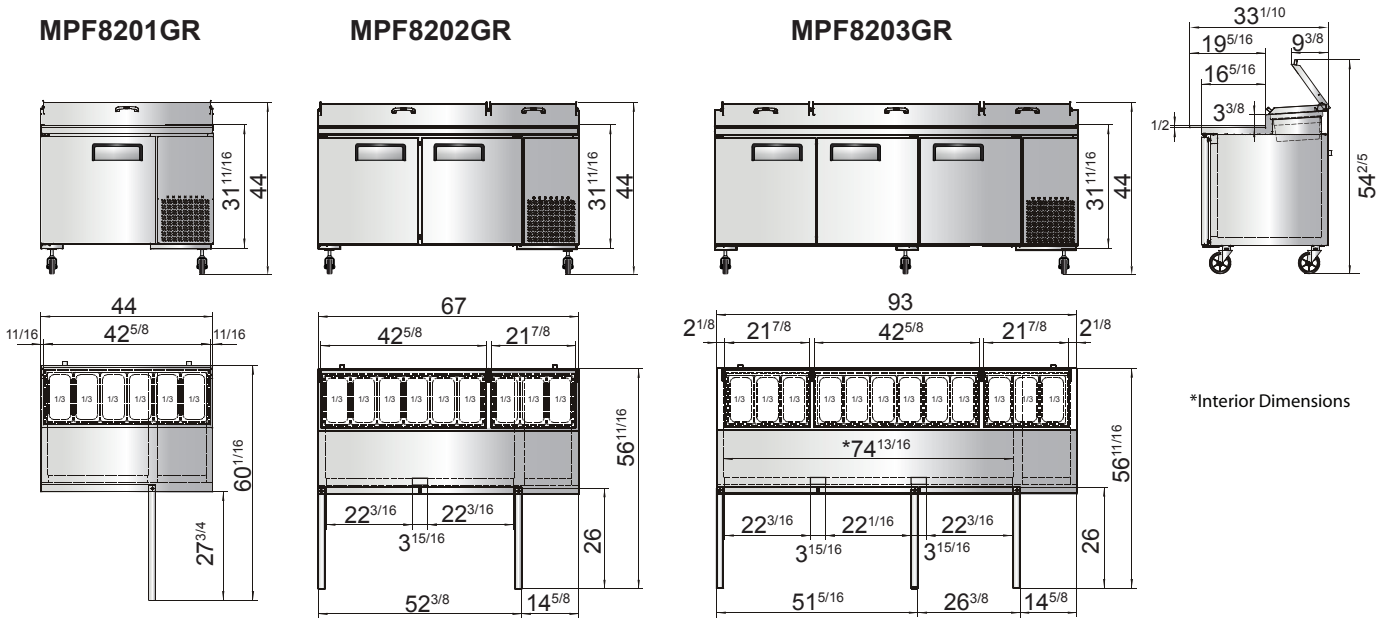

Worktops & Undercounters

Casters



Epoxy shelves



Stainless steel pans



Temperature control



NEMA 5-15P

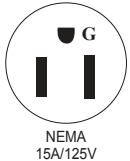



“WE MAKE THE KITCHEN BETTER!”

Toll Free: 855-855-0399 Email: info@atosausa.com
www.atosausa.com | www.atosausa.com
California, Colorado, Florida, Georgia, Illinois,
Massachusetts, New Jersey, Ohio, Texas, Washington

Undercounter Refrigerators

Standard Features

- Stainless steel exterior & interior with reinforced stainless steel top
- Environmentally friendly R290 refrigerant
- Dixell digital controller
- Maintains temperatures between 33°F - 40°F
- Recessed door handle(s)
- Self-closing door(s) with stay open feature
- Magnetic door gasket(s) standard for positive door seal
- Pre-installed casters
- One(1) pre-installed shelf per section

MODELS:

MGF8401GR / MGF8402GR
MGF8403GR / MGF8404GR



MGF8401GR



MGF8402GR



MGF8403GR



MGF8404GR

For the best results of food preservation we recommend setting your refrigerator between 33 °F to 38 °F

1. Don't forget to leave the unit some room to breathe!
2. Please clean the condenser frequently to give the unit more fresh air.



2 YEAR PARTS AND LABOR WARRANTY (US ONLY)
5 YEAR COMPRESSOR PART WARRANTY (US ONLY)



For confirmation and updates on the latest energy star models, please visit energystar.gov



"WE MAKE THE KITCHEN BETTER!"

Toll Free: 855-855-0399 Email: info@atosausa.com
 www.atosa.com | www.atosausa.com
 California, Colorado, Florida, Georgia, Illinois,
 Massachusetts, New Jersey, Ohio, Texas, Washington

SPECIFICATIONS

Models	Door	Capacity (Cu.Ft.)	Shelves	Casters (inch)	Amps (A)	Voltage (V/Hz/Ph)	HP	Refrigerant	Exterior Dimensions (inch)	Net Weight (lbs)	Gross Weight (lbs)
MGF8401GR	1	7.2	1	2	2.3	115/60/1	1/7	R290	27 ^{1/2} ×30×34 ^{1/5}	137	172
MGF8402GR	2	13.4	2	2	2.3	115/60/1	1/7	R290	48 ^{3/10} ×30×34 ^{1/5}	192	231
MGF8403GR	2	17.2	2	2	2.8	115/60/1	1/5	R290	60 ^{3/10} ×30×34 ^{1/5}	218	265
MGF8404GR	3	21.1	3	2	2.8	115/60/1	1/5	R290	72 ^{7/10} ×30×34 ^{1/5}	254	315

PLAN VIEW

MGF8401GR

MGF8402GR

MGF8403GR

MGF8404GR

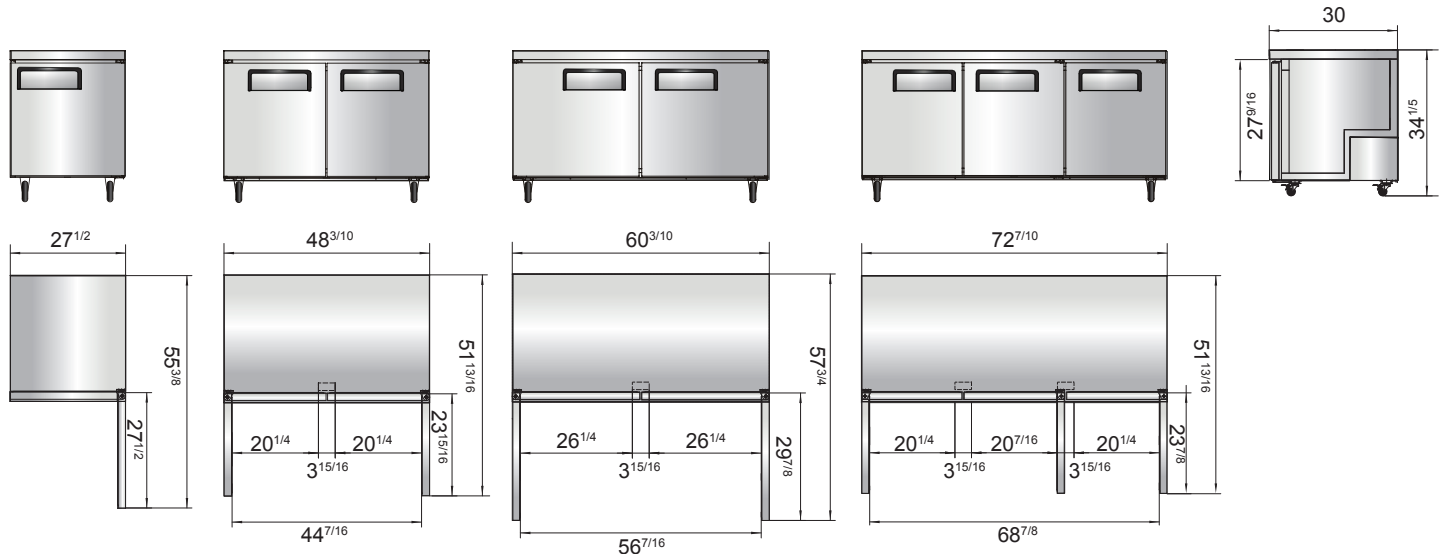

Casters

Epoxy shelves

Rear grate

Temperature control



NEMA 5-15P





“WE MAKE THE KITCHEN BETTER!”

Toll Free: 855-855-0399 Email: info@atosausa.com
www.atosa.com | www.atosausa.com
California, Colorado, Florida, Georgia, Illinois,
Massachusetts, New Jersey, Ohio, Texas, Washington

Undercounter Freezers

MODELS:

MGF8405GR / MGF8406GR

Standard Features

- Stainless steel exterior & interior with reinforced stainless steel top
- Environmentally friendly R290 refrigerant
- Dixell digital controller
- Maintains temperatures between -8°F – 0°F
- Recessed door handle(s)
- Self-closing door(s) with stay open feature
- Magnetic door gasket(s) standard for positive door seal
- Pre-installed casters
- One(1) pre-installed shelf per section



MGF8405GR



MGF8406GR

For the best results of food preservation we recommend setting your freezer between -8 °F to 0 °F

1. Don't forget to leave the unit some room to breathe!
2. Please clean the condenser frequently to give the unit more fresh air.



2 YEAR PARTS AND LABOR WARRANTY (US ONLY)
5 YEAR COMPRESSOR PART WARRANTY (US ONLY)





“WE MAKE THE KITCHEN BETTER!”

Toll Free: 855-855-0399 Email: info@atosausa.com
www.atosa.com | www.atosausa.com
 California, Colorado, Florida, Georgia, Illinois,
 Massachusetts, New Jersey, Ohio, Texas, Washington

SPECIFICATIONS

Models	Door	Capacity (Cu.Ft.)	Shelves	Casters (inch)	Amps (A)	Voltage (V/Hz/Ph)	HP	Refrigerant	Exterior Dimensions (inch)	Net Weight (lbs)	Gross Weight (lbs)
MGF8405GR	1	7.2	1	2	1.8	115/60/1	1/5	R290	27 ^{1/2} ×30×34 ^{1/5}	146	179
MGF8406GR	2	13.4	2	2	2.6	115/60/1	1/4	R290	48 ^{1/5} ×30×34 ^{1/5}	203	245

PLAN VIEW

MGF8405GR

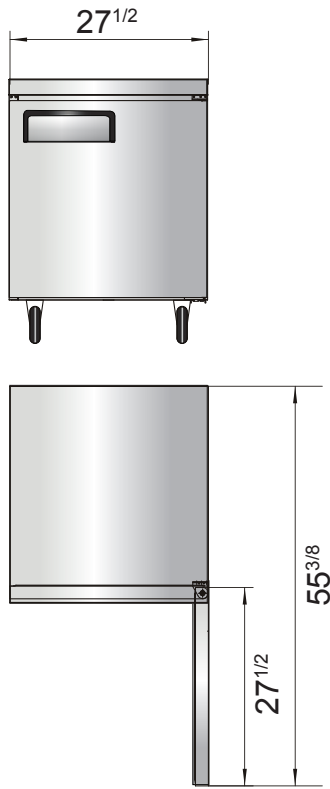

MGF8406GR

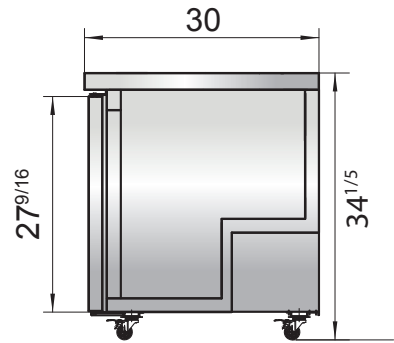
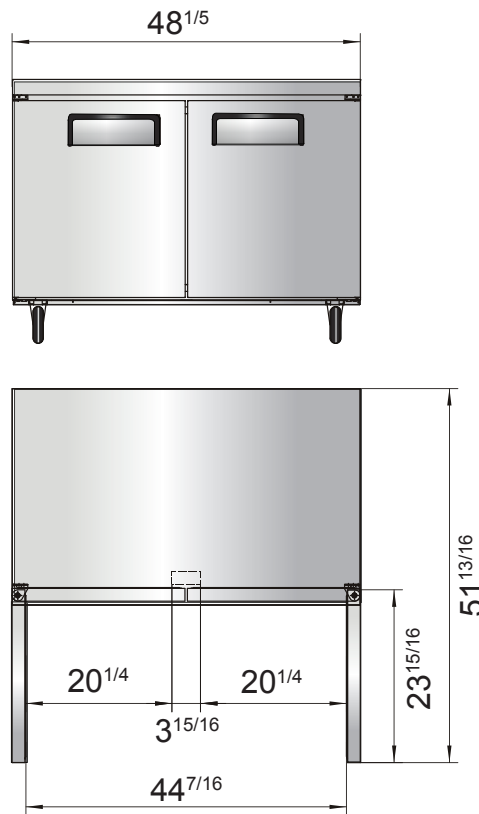

Casters



Epoxy shelves



Rear grate



Temperature control



NEMA 5-15P





"WE MAKE THE KITCHEN BETTER!"

Toll Free: 855-855-0399 Email: info@atosausa.com
www.atosa.com | www.atosausa.com
California, Colorado, Florida, Georgia, Illinois,
Massachusetts, New Jersey, Ohio, Texas, Washington

Refrigerated Chef Bases

Standard Features

- Stainless steel exterior and interior
- Stainless steel pans included
- Dixell digital controller
- Maintains temperatures between 34°F – 40°F
- Heavy duty embraco controller with environmentally friendly R290 refrigerant
- Heavy duty stainless steel drawer slides and rollers
- Magnetic drawer gaskets
- Recessed door handles
- Pre-installed casters
- One-piece heavy duty reinforced stainless steel top to support counter top equipment
- Gravity fed self closing drawers

MODELS:

MGF8450GR / MGF8451GR / MGF8452GR
MGF8453GR / MGF8454GR



MGF8450GR



MGF8451GR



MGF8452GR



MGF8453GR



MGF8454GR

For the best results of food preservation we recommend setting your refrigerator between 33 °F to 38 °F

1. Don't forget to leave the unit some room to breathe!
2. Please clean the condenser frequently to give the unit more fresh air.



2 YEAR PARTS AND LABOR WARRANTY (US ONLY)
5 YEAR COMPRESSOR PART WARRANTY (US ONLY)





“WE MAKE THE KITCHEN BETTER!”

Toll Free: 855-855-0399 Email: info@atosausa.com

www.atosausa.com | www.atosausa.com

California, Colorado, Florida, Georgia, Illinois, Massachusetts, New Jersey, Ohio, Texas, Washington

SPECIFICATIONS

Models	Door	Capacity (Cu.Ft.)	Pans Per Unit	Casters (inch)	Amps (A)	Voltage (V/Hz/Ph)	HP	Refrigerant	Exterior Dimensions (inch)	Net Weight (lbs)	Gross Weight (lbs)
MGF8450GR	2	7.7	4*1/1 & 6*1/6	5	2.3	115/60/1	1/7	R290	48 ^{2/5} ×32×26 ^{3/5}	220	258
MGF8451GR	2	8.4	6*1/1	5	2.3	115/60/1	1/7	R290	51 ^{4/5} ×32×26 ^{3/5}	229	273
MGF8452GR	4	8.4	6*1/1	5	2.3	115/60/1	1/7	R290	60 ^{1/2} ×32×26 ^{3/5}	234	282
MGF8453GR	4	12.1	8*1/1	5	2.3	115/60/1	1/7	R290	72 ^{2/5} ×32×26 ^{3/5}	300	364
MGF8454GR	4	12.1	8*1/1	5	2.3	115/60/1	1/7	R290	76×32×26 ^{3/5}	309	368

PLAN VIEW

MGF8450GR

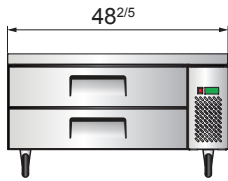

MGF8451GR

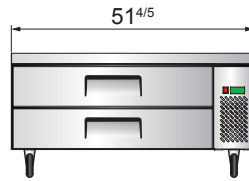

MGF8452GR

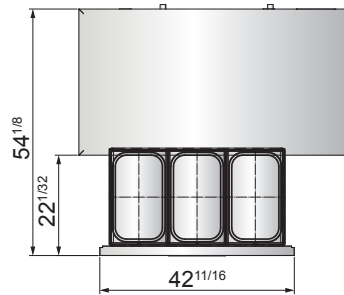
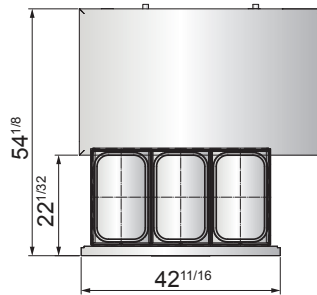
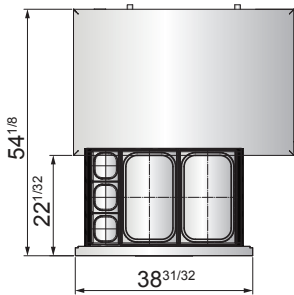
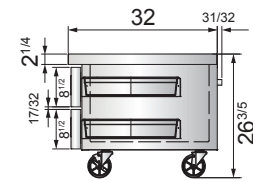
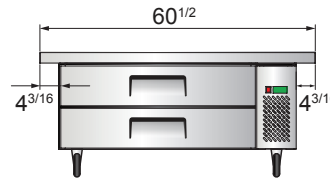

MGF8453GR

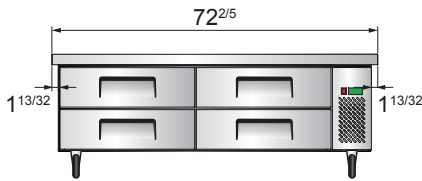

MGF8454GR

